

Radio IND Electronics

TELEVISION · SERVICING · HIGH FIDELITY

A
GERNSBACK
PUBLICATION

NEW! PRIVATE STEREO
With Tiny Hi-Fi Headset Amplifier

Build the Colorgan—
Light With Your Music

Dangerous Interference
From TV Receivers

Transistor and Hybrid
Auto Radio Troubles



**WORLD'S LARGEST SELLING
AND WORLD'S NEWEST**

Hand Size V-O-M's



MODEL 310-C
World's Newest
Volt-Ohm-Milliammeter



MODEL 310
World's Largest Selling
Volt-Ohm-Milliammeter



**BOTH TESTERS
SHOWN
ACTUAL SIZE**

- 1** **HAND SIZE AND LIGHTWEIGHT**, but with the features of full-size V-O-M's.
- 2** **20,000 OHMS PER VOLT DC; 5,000 AC (310)—15,000 AC (310-C).**
- 3** **EXCLUSIVE SINGLE SELECTOR SWITCH** speeds circuit and range settings. The first miniature V-O-M's with this exclusive feature for quick, fool-proof selection of all ranges.

SELF-SHIELDED Bar-Ring instrument; permits checking in strong magnetic fields. FITTING INTERCHANGEABLE test prod tip into top of tester makes it the common probe, thereby freeing one hand. UNBREAKABLE plastic meter window. BANANA-TYPE JACKS—positive connection and long life.

Model 310—\$37.50 Model 310-C—\$44.50 Model 369 Leather Case—\$3.20

ALL PRICES ARE SUGGESTED U.S.A. USER NET, SUBJECT TO CHANGE

THE TRIPLETT ELECTRICAL INSTRUMENT COMPANY, BLUFFTON, OHIO

310-C PLUS FEATURES

1. Fully enclosed lever range switch
2. 15,000 Ohms per volt AC (20,000 O/V DC same as 310)
3. Reversing switch for DC measurements

MODELS 100 AND 100-C

Comprehensive test sets. Model 100 includes: Model 310 V-O-M, Model 10 Clamp-on Ammeter Adapter; Model 101 Line Separator; Model 379 Leather Case; Model 311 leads. (\$67.10 Value Separate Unit Purchase Price.)

MODEL 100—U.S.A. User Net. \$64.50
MODEL 100-C — Same as above, but with Model 310-C. Net.\$71.50



Circle 1 on reader's service card

USES UNLIMITED: FIELD ENGINEERS • ELECTRICAL, RADIO, TV, AND APPLIANCE SERVICEMEN • ELECTRICAL CONTRACTORS • FACTORY MAINTENANCE MEN • ELECTRONIC TECHNICIANS • HOME OWNERS, HOBBYISTS
THE WORLD'S MOST COMPLETE LINE OF V-O-M's • AVAILABLE FROM YOUR TRIPLETT DISTRIBUTOR'S STOCK

Crime does pay!

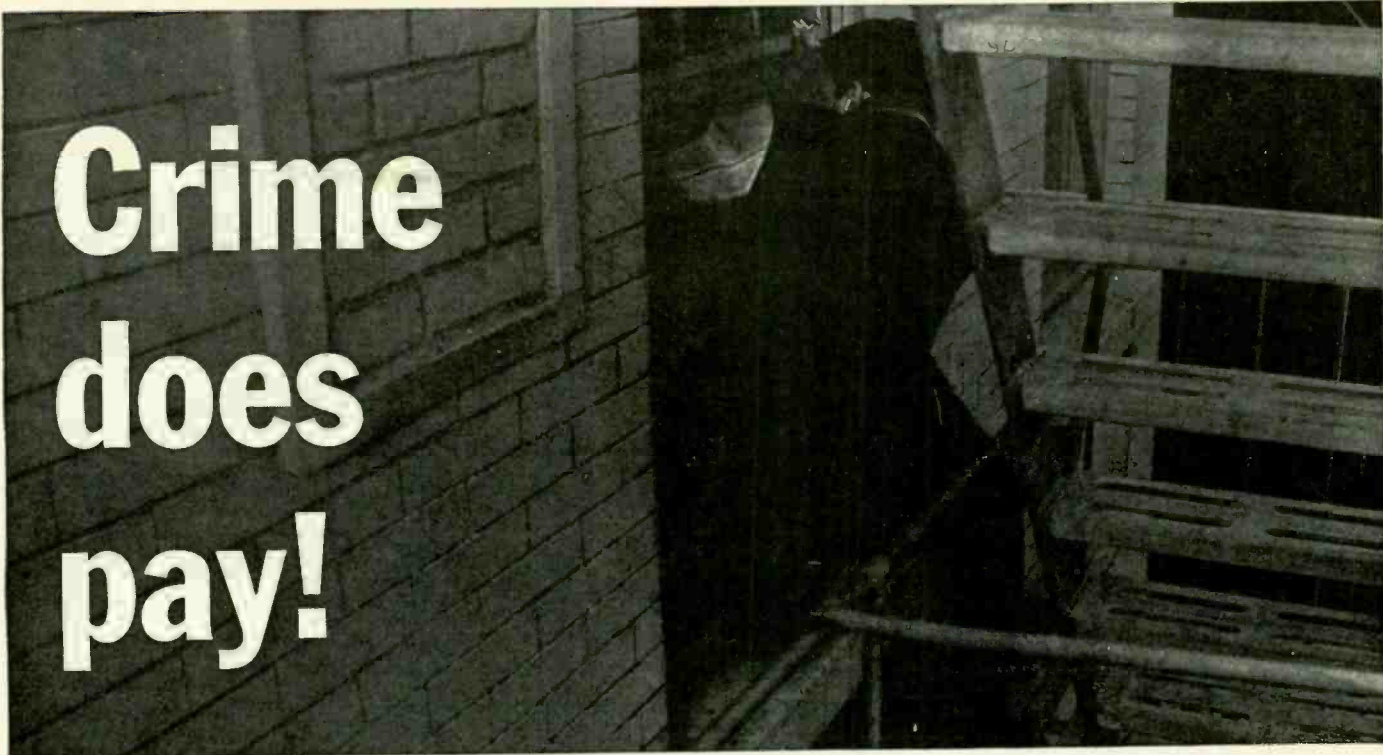

Every 40 seconds a burglary takes place in the United States.

TECHNICAL INFORMATION

The RADAR SENTRY ALARM is a complete U.H.F. Doppler Radar System which saturates the entire protected area with invisible r.f. microwaves. It provides complete wall to wall—floor to ceiling protection for an area of up to 5,000 square feet. Without human movement in the protected area, the microwave signal remains stable. Any human movement (operation is unaffected by rodents and small animals) in the area causes the doppler signal to change frequency approximately 2 to 4 cps. An ultra-stable low frequency detector senses this small frequency change, amplifies it and triggers the police type siren—which is heard up to a half mile away.

In addition, the RADAR SENTRY ALARM's protection can be extended to other areas with the use of the following optional accessories:

- remote detectors for extending coverage to over 10,000 sq. ft.
- rate of rise fire detector U.L. approved for 2,500 sq. ft. of coverage each (no limit on the number of remote detectors that can be used)
- hold-up alarm
- central station or police station transmitter and receiver (used with a leased telephone line)
- relay unit for activating house lights
- battery operated horn or bell which sounds in the event of: powerline failure; equipment malfunction or tampering

At that rate, it's a multi-million dollar a year business...for burglars.

And an even better business opportunity for you.

Why? Because burglary can be stopped...with an effective alarm system.

In fact, police and insurance officials have proved that an alarm system reduces, and in many cases, eliminates losses—even helps police apprehend the criminal.

Here's where you come in.

Only a small percentage of the more than 100 million buildings—stores, offices, factories, schools, churches and homes are protected by an effective alarm system.

That means virtually every home, every business is a prospect.

You can sell them!

And you don't have to be a super-salesman to sell the best protection available—a Radar Sentry Alarm unit. All you have to do is demonstrate it...it sells itself.

A glance at the technical information shows why.

It's the most unique and effective alarm system ever invented.

And here's the proof.

In the past six years, thousands of RADAR SENTRY ALARM units have been sold in the Detroit, Michigan area alone—sold by men like yourself on a part-time and full-time basis.

Here are just a few customers who are protected by RADAR SENTRY ALARMS:

U.S. Government
U.S. Air Force
Detroit Board of Education
Hundreds of Churches,
Banks, Businesses and
Homes.

Everyone is a prospect.

So take advantage of your profession. Put your technical knowledge and experience to work for you in a totally new area—an area that will make money for you!

Don't wait!

Let us prove that crime does pay.

Become a distributor.

Write now for free details.

RADAR SENTRY ALARM



Circle 2 on reader's service card

Mail to: RADAR DEVICES MANUFACTURING CORP.
22003 Harper Ave., St. Clair Shores, Michigan 48080



Please tell me how I can have a business of my own distributing Radar Sentry Alarm Systems. I understand there is no obligation.

Name _____ RE-10

Address _____

City _____ State & Code _____

This is the best capacitor value you'll ever find!

look for this display at your Centralab distributor



**MINUTE-MENDER
TIMER
FREE**
WITH THIS KIT OF 100 CERAMIC DISC CAPACITORS
IN THE 9 MOST POPULAR VALUES

Here are some of the
**MANY USES FOR THIS
PRECISION TIMER**

- Check parking time
- Time that repair job
- Calculate travel time
- Cook a "tough dog" for 30 minutes
- Take it home to your wife to
 - Time an egg
 - Heat a pizza
 - Bake a cake
- Limit long distance calls
- Be back on time
- Take 5 and time it
- Pre-heat filaments for ten
- Form new "Lytics" in five
- Remind her to call you
- Sun bathe safely
- Make her happy

CDM-100 KIT CONTAINS
THESE REPLACEMENT
CAPACITORS FOR
"ON THE SPOT" COVERAGE

Contents			
100 MFD	10%	1KV	DD-101 10,000
270 MFD	10%	1KV	DD-102 10,000
470 MFD	10%	1KV	DD-103 10,000
100 MFD	10%	1KV	DD-104 10,000
100 MFD	10%	1KV	DD-105 10,000
100 MFD	10%	1KV	DD-106 10,000
100 MFD	10%	1KV	DD-107 10,000
100 MFD	10%	1KV	DD-108 10,000
100 MFD	10%	1KV	DD-109 10,000
100 MFD	10%	1KV	DD-110 10,000

\$16.95
only
Reg. value \$25.25



or ask
**your salesman for
full information...**

Centralab

DIVISION OF GLOBE-UNION INC.

P. O. BOX 591 • MILWAUKEE, WISCONSIN 53201

D-6510

Circle 3 on reader's service card

OUR COVER GAL is enjoying a new kind of hi-fi system—great for nighttime listening. The heart of it is Shure Brothers' new SA-1 Solo-Phone, a stereo amplifier designed exclusively for headset listening. You can set up a similar system for about \$100. Read all about it on PAGE 66.

The other equipment on the cover: a Perpetuum Ebner PE-34 automatic turntable, and a Jensen HS-2 stereo headset. Cover photo by Harry Schlack.

BUILD THIS FASCINATING COLORGAN

Relationships between colors and music have fascinated people for years. Until now, most color organs—which display colored lights to music from a radio or phonograph—have been complex, cumbersome things. This one, though, is easy to build. It uses silicon controlled rectifiers for simplicity, efficiency and low cost. Input impedance is high enough not to bother the sound source. You'll want to build the Colorgan.

See how-to-do-it easily from
start to successful finish. . .
PAGE 34

Meyer evaluates . . . TRANSISTOR OUTPUT CIRCUITS

Daniel E. Meyer, well known to RADIO-ELECTRONICS readers as the designer of several outstanding transistor amplifier and preamp construction projects, describes a variety of transistor output circuits, exploring their merits and drawbacks. Now that things have settled a bit, most manufacturers stick with two or three tried-and-true circuits.

Get the complete, eye-opening
report. . . **PAGE 38**

MYSTERY RADIATION FROM 42-MC-I.F. TV SETS

A Nebraska sheriff kept getting TV sound (from various channels) on his 39.9-mc public-service receiver, in spite of months of experiments with filters, traps and suppressors. Finally someone realized that dozens of TV sets were reradiating programs on that frequency. It could be happening in your town! Read what was done about it.

Turn now to **PAGE 54** for
the entire behind-the-scenes
story

EDITORIAL

- 33 Television in Space.....Hugo Gernsback
53 The August Editorial: A Reply

ELECTRONICS

- 34 The Colorgan.....Donald Lancaster
Music is more exciting with electronic splashes of colored light
42 Microwave Motors—Space-Age Power?.....Harry E. Stockman
Radiation runs these brushless motors you can build
45 Equipment Report: Knight-Kit KG-275 Exposure Meter
58 Make Your Own TCS's!.....Wendell E. Lavender
Transistor controlled switches ("homemade SCR's") you can experiment with

TELEVISION

- 41 TV Technician's Dictionary.....Frank A. Salerno
A servicer's guide to basic emotions
54 Spurious Radiation from 42-MC-I.F. TV Sets.....Eugene Austin
Midwestern sheriff's two-way radio was disrupted by TV programs
101 Putting in an Automatic Degausser.....Homer L. Davidson
Pictures make it easy

RADIO

- 49 Ten Transistor and Hybrid Auto Radio Troubles.....David Held
Most of them surround the transistor output
56 Signaling Systems for CB Stations.....E. L. Safford, Jr.
Add these simple circuits to your CB rig

TEST INSTRUMENTS

- 44 VOM Scale Expander Measures Low Resistances.....R. C. Roetger
Checks small coils, cables, contact resistance, etc.
68 Equipment Report: Lectrotech T-100 Horizontal Deflection Circuit Meter

AUDIO-HIGH FIDELITY-STEREO

- 38 Latest Transistor Power Amplifier Designs.....Daniel E. Meyer
What are the major manufacturers doing?
46 The Old-Timer Builds the Intercombo.....Jack Darr
Between cupsa coffee, the Young Ham learns about intercoms and sound systems
COVER STORY 61 Headset Hi-Fi: The Shure Solo-phone Stereo Amplifier.....Peter E. Sutheim
A tiny-watt amplifier made just for stereo phones
66 Equipment Report: The KSC Speaker Balancing Record

GENERAL

- 22 Service Clinic.....Jack Darr
Setting Up a Master Antenna System
52 Make a Variable Electrolytic.....Tom Jaski
Easy-to-make experimenter's aid also demonstrates principle of electrolytic capacitor
60 What's Your EQ?

THE DEPARTMENTS

12 Correspondence
112 New Books
86 New Literature

81 New Products
70 New Semiconductors & Tubes
4 News Briefs

104 Noteworthy Circuits
94 Technotes
96 Try This One
60 50 Years Ago

98 Reader's Service Page



Member,
Institute of High Fidelity
Radio-Electronics
is Indexed in
Applied Science
& Technology Index
(Formerly
Industrial Arts Index).

HUGO GERNSBACK, editor-in chief and publisher. M. HARVEY GERNSBACK, editor. Fred Shunaman, managing editor. Robert F. Scott, W2PWG, technical editor. Peter E. Sutheim, associate editor. Jack Darr, service editor. I. Queen, editorial associate. John J. Lamson, eastern sales manager. Wm. Lyon McLaughlin, technical illustration director.

RADIO-ELECTRONICS, October 1965, Volume XXXVI, No. 10. Published Monthly at Ferry Street, Concord, N.H. 03302. Second-class postage paid at Concord, N.H. SUBSCRIPTION RATES: U. S. and possessions, Canada: \$5 for 1, \$9 for 2, \$12 for 3 years. Pan-American countries: \$6 for 1, \$11 for 2, \$15 for 3 years. Other countries: \$6.50 for 1, \$12 for 2, \$16.50 for 3 years. Single copies: 50¢. © 1965, by Gernsback Publications, Inc. All rights reserved. POSTMASTERS: Send Form 3579 to 154 W. 14th St., New York 10011.

NEWS BRIEFS

FLOWING GAS LASER HAS 16 WATTS OUTPUT

A gas laser with the highest continuous output so far observed has been reported by Dr. C. K. N. Patel of Bell Telephone Laboratories. It puts out 16 watts of power at 10.6 microns.

The new laser operates by transferring the energy of excited nitrogen molecules to molecules of carbon dioxide. Both gases flow continuously through an interaction zone, where the laser action takes place.

Dr. Patel discovered that not only could this transfer produce laser action, but that it resulted in extraordinary efficiencies, due to the lower-lying energy states of the nitrogen molecules. The lifetime of the excited state in nitrogen is 10,000 times longer than the lifetime of the metastable states of helium under similar conditions. This results in getting more than 30% of the vibrationally excited molecules to give off their energy to the carbon dioxide.

AUDIO ENGINEERING SOCIETY HOLDS 17TH CONVENTION

The Audio Engineering Society is presenting the most ambitious program of its history in the convention to be held at the Hotel Barbizon-Plaza, New York City, Oct. 11 through 15. Thirteen sessions of 6 to 9 papers each are being presented at the 5-day convention—Monday, Tuesday and Wednesday in the morning, afternoon and evening, Thursday and Friday mornings and afternoons only.

The papers cover the widest range of subjects, from microphones to earphones, amplifiers to speakers, and some electronic music (billed as "Music and Electronics"), to miniaturized audio applications, record-cleaning and speech analytics. A manufacturers' exhibit of professional audio and high-fidelity equipment will run from Monday through Thursday, noon to 6:45 pm, except on Thursday, when it will be closed at 5 pm.

DELAWARE INITIATES STATE-WIDE EDUCATIONAL TV SYSTEM

With the beginning of school in September, all Delaware schools are linked into a state educational TV network. There is a main studio and tower site at Dover, which feeds six receiving tower sites throughout the state. From these, programs will be carried by coaxial cables to about 25 "head-end" schools, which act as control and trans-

mitting points for the other schools in their districts. Three television channels in the 11-gigacycle range are being used in the Delaware closed-circuit network.

AUTOMATIC LANDING SYSTEM PACKS IN A SUITCASE

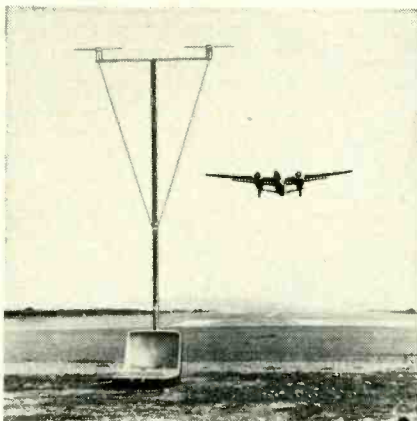

The Cubic Vorloc (very-high-frequency omni-range localizer) shows what it can do at Montgomery Field in San Diego, Calif.

A portable, inexpensive electronic localizer to transmit guidance signals to approaching aircraft has been announced by Lear Siegler, Inc. and Cubic Corp. The *Cubic Vorloc* weighs 20 lb. and can be set up in 30 minutes. It has a range of about 20 miles, and an accuracy of less than 1° of approach angle. The new localizer is expected to be very useful for private airstrips and small airports that cannot afford conventional localizers. The localizer works only in the lateral or side-to-side axis. With a glide-slope transmitter added to it, it can make a complete portable instrument landing system. Cubic is now designing such a glide-slope transmitter, to be suitcase-size also.

SCR'S TO BRING MARVELS TO THE AVERAGE HOUSEWIFE

The General Electric Co. has announced that a price breakthrough on silicon controlled rectifiers "will have a profound effect on a wide range of products that we use every day—from automobiles to toasters."

The announcement was made by Dr. L. C. Maier, Jr., general manager of G-E's semiconductor products department, in connection with an announcement of a small silicon controlled rectifier that would sell at about half the cost of present comparable units.

Electronics, Dr. Maier said, has been slow in coming into the home, because of prohibitive costs. Now, housewives may have a variety of devices, including individual lamps that can be turned to any desired brightness, reliable variable-speed sewing machines and mixers, and even a device the size of a small transistor radio that the housewife can carry around in her pocket to act as a remote timer for a washer or dryer, or as an alarm clock to tell her when it's time to get dinner ready.

The new SCR, which is made on automatic machinery, is encapsulated in plastic, and has a heat-dissipating vane which can be broken off for greater compactness in low-power applications where the vane is not needed.

PAY TV DESTINED TO FAIL?

Pay TV cannot succeed, according to a study made by Oxtoby-Smith for CBS, and reported by *Television Digest*. The reasons, according to the study, are: not enough subscribers who will spend enough money; the demand for cultural programs, which was considered so important, turns out to be a fallacy; pay TV is used only occasionally (once or twice a week) in the home; pay TV does not provide that "elusive something better" than ordinary TV.

Most surprising finding of the survey was that viewers either do not want the culture they had asked for, or that they had not been supplied with programs that satisfied them. Two-thirds of the subscribers to the Los Angeles system said they wanted Broadway plays before the service started. But only 4% actually watched the plays when they were supplied.

OPTICAL-FREQUENCY OSCILLATOR CAN NOW BE TUNED

Two Bell scientists, Joseph A. Giordmaine and Robert C. Miller, have demonstrated tunable optical parametric oscillation in a lithium metaniobate crystal. The wavelength of the coherent light emitted by the oscillator was tuned over most of the region between 9,700 and 11,500 Angstroms.

Giordmaine and Miller used a lithium metaniobate crystal 4.5 mm long and 5 mm in diameter. Its end surfaces were coated with a dielectric film to form an optical resonator, or cavity. The second harmonic (5,290 Angstroms) of a pulsed calcium tungstate-neodymium-doped laser was used to pump the oscillator.

The actual tuning was done by

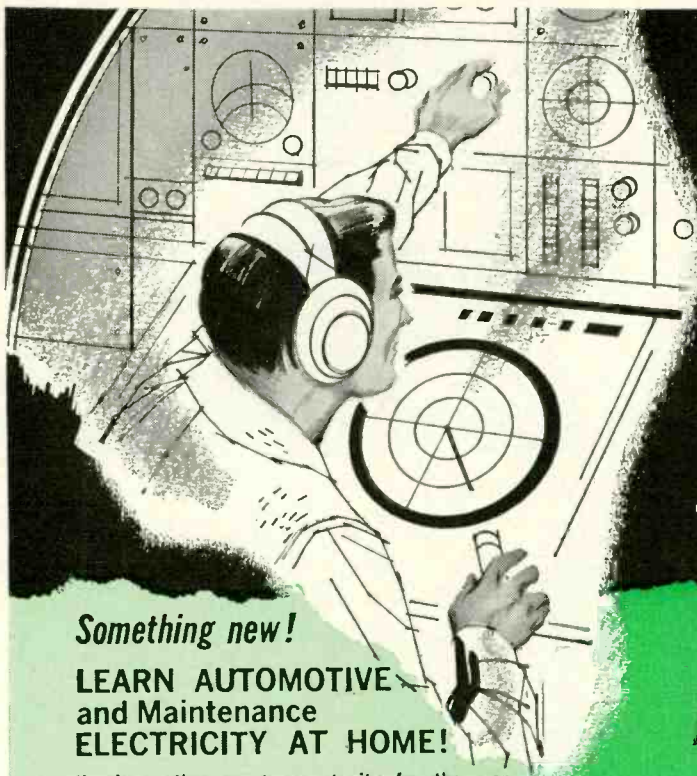

5,000 FIRMS HAVE EMPLOYED DeVRY TECH ELECTRONICS GRADUATES...

There Must be a Reason!

Something new!

LEARN AUTOMOTIVE and Maintenance ELECTRICITY AT HOME!

Here's another great opportunity for the man who wants his own business or a bigger pay check with a brighter future. It is a NEW DeVry program that gives you the advantage of earning while you learn.

Prepare in spare time at home for profitable jobs which can take you all the way from trouble-shooting on the electrical systems of automobiles, marine engines, trucks, tractors and other gasoline engines, to the general maintenance of electrical equipment in the home or in light industry.

DeVry's new program "brings the classroom to your home" through the magic of AUDIO-VISUAL AIDS: Lectures recorded by DeVry instructors combined with colorful 8 x 10" transparencies to make learning easier. You get the advantages of "programmed" learning through modern texts which are also handy for future



reference. To develop practical skill, you get and keep valuable shop equipment and manuals. This includes building the brand-new DeVry Transistorized Automotive Analyzer and the DeVry Silicon Battery Charger — ideal "tools" for earning extra money as you go.

This new program covers the entire electrical systems in automobiles and other vehicles, including transistorized ignition systems, alternators and regulators, and other applications. In the maintenance field, it covers lighting, electric motors, controls, wiring — even transistors. The graduate from this program can be either a specialist as a troubleshooter on the electrical system of an automobile, or handle electrical lighting, heating, alarm and control systems. It is ideal for "one man" maintenance departments.

Check coupon at right and mail it today for FREE facts.

Let Us Prepare You at Home or In
One of Our Two Big Resident Schools
for a Profitable Career in

ELECTRONICS

Across the continent, leading employers of personnel trained in electronics tell us that DeVry training is "Tops." Get the full story of DeVry Tech and the advantages it offers, by filling in the coupon below. The two free booklets pictured below tell of many fine opportunities for trained men in electronics: the great variety of jobs, from research, production, operation, maintenance and servicing of electronic equipment — to a neighborhood TV-radio sales and service business of your own. They'll tell you too, how DeVry has prepared men for good jobs with outstanding firms: on practical, "brass-tacks" problems with actual electronic equipment.

Here's good news: you don't need advanced education or previous technical experience to get started. If you can follow simple directions, you should be able to prepare with DeVry's help for real money in a field that may offer the opportunity of your lifetime.

Employment Service: With many employers so enthusiastic about DeVry Tech graduates, it's no wonder our Employment Service can help our graduates get started in electronics, or can assist them toward promotions later.

FREE!

SEND COUPON
FOR BOOKLETS
ON ELECTRONICS
AS A CAREER



DeVRY TECHNICAL INSTITUTE

4141 Belmont Ave., Chicago, Ill. 60641, Dept. RE-10-V

I AM INTERESTED IN ELECTRONICS. Please give me your two free booklets, "Pocket Guide to Real Earnings" and "Electronics in Space Travel"; also include details on how to prepare for a career in this field. The following opportunity fields (check one or more) interest me:

- | | |
|--|---|
| <input type="checkbox"/> Space & Missile Electronics | <input type="checkbox"/> Communications |
| <input type="checkbox"/> Television & Radio | <input type="checkbox"/> Computers |
| <input type="checkbox"/> Microwaves | <input type="checkbox"/> Industrial Electronics |
| <input type="checkbox"/> Automation Electronics | <input type="checkbox"/> Broadcasting |
| <input type="checkbox"/> Radar | <input type="checkbox"/> Electronic Control |

I AM INTERESTED IN AUTOMOTIVE AND MAINTENANCE ELECTRICITY. Please supply further information.

NAME _____ AGE _____

ADDRESS _____ APT. _____

CITY _____ STATE _____ ZIP _____

Check here if you are under 16 years of age.

2095A

ACCREDITED MEMBER OF NATIONAL HOME STUDY COUNCIL

DeVry Technical Institute
Chicago • Toronto

Circle 5 on reader's service card

COMPLETE TUNER OVERHAUL

ALL MAKES—ONE PRICE

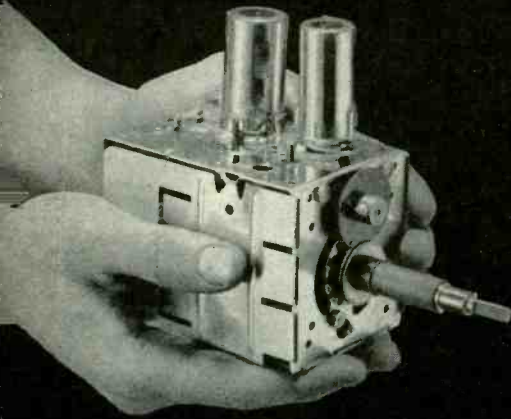

995

ALL LABOR AND PARTS

(EXCEPT TUBES & TRANSISTORS)*

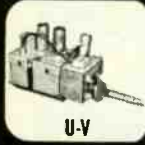

Guaranteed Color Alignment—No Addit. Charge

Simply send us the defective tuner complete; include tubes, shield cover and any damaged parts with model number and complaint. Your tuner will be expertly overhauled and returned promptly, performance restored, aligned to original standards and warranted for 90 days.

UV combination tuner must be single chassis type; dismantle tandem UHF and VHF tuners and send in the defective unit only.

Exact Replacements are available for tuners unfit for overhaul. As low as \$12.95 exchange. (Replacements are new or rebuilt.)

Pioneers in TV Tuner Overhauling

CASTLE

TV TUNER SERVICE, INC.

MAIN PLANT: 5715 N. Western Ave., Chicago 45, Illinois
 EAST: 41-96 Vernon Blvd., Long Island City 1, N.Y.
 CANADA: 136 Main Street, Toronto 13, Ontario

*Major Parts are additional in Canada

R. C. Miller and J. A. Giordmaine of Bell Labs aligning the lithium metaniobate crystal of the first coherent-light oscillator that can be tuned over a wide range of frequencies.

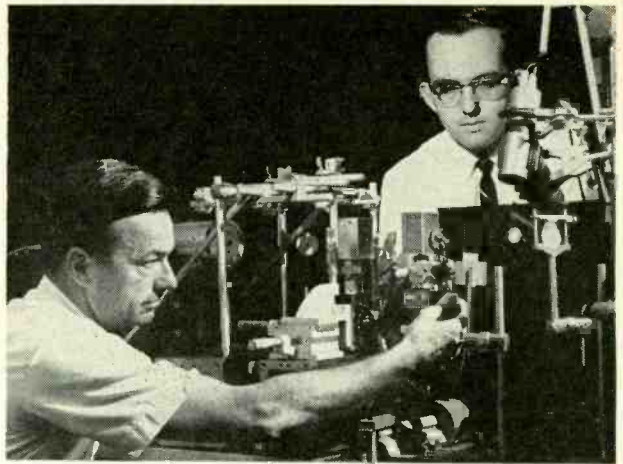

varying the temperature of the oscillator. A change of 12°C shifted the wavelength enough to tune the equipment over the range stated.

PHILADELPHIA SERVICE TECHS. PROMOTE UHF TELEVISION

The Television Service Association of Delaware Valley and the Tri-State Council of TV Service Associations, representing technicians in Eastern Pennsylvania, Southern New Jersey and Delaware, are undertaking a campaign to get more customers to use uhf converters.

The new uhf channel-29 station is the object of the promotion. The station (WIBF-TV) is cooperating with spots on its sister FM station, as well as commercials on the station itself.

MAX LIEBOWITZ DEAD

Max Liebowitz, founder of the Associated Radio & Television Technicians of New York City (ARTSNY), and one of the founders of the Empire State Federation of Electronic Technicians Associations, died Aug. 4 at his home in Flushing, N. Y., at the age

RADIO-ELECTRONICS is published by Gernsback Publications, Inc. Chairman of the Board: Hugo Gernsback President: M. Harvey Gernsback Vice President-Secretary: G. Aliquo Vice President-Treasurer: Charles A. Raible

Editorial, Advertising, Subscription and Executive offices: 154 West 14th Street, New York 10011.

Subscribers: When requesting change of address please furnish an address label from a recent issue. Allow one month for change of address.

ADVERTISING REPRESENTATIVES:

East: John J. Lamson, Eastern Sales Manager, RADIO-ELECTRONICS, 154 West 14th Street, New York 10011, 212 AL 5-7755; Midwest: P. H. Dempers Co., 740 North Rush Street, Chicago, Illinois 60611, 312 MI 2-4245; Texas/Arkansas: Media Representatives, Inc., 2600 Douglas Avenue, Irving, Texas 57060, 214 BL 5-6573; West Coast/Oklahoma: Husted-Coughlin, Inc., 1830 W. 8th Street, Los Angeles, Calif. 90057, 213 389-3132; Husted-Coughlin, Inc., 444 Market Street, San Francisco, Calif. 94111, 415 GA 1-0151; United Kingdom: Publishing & Distributing Co., Ltd., Mitre House, 177 Regent St., London W.1, England.

◀ Circle 6 on reader's service card

of 56. He was also first president of an early national organization, the National Electronic Technicians & Service Dealers Association.

The death was sudden, caused by a cerebral hemorrhage. At the time of his death, Max was publicity director for ESFETA and ARTSNY, as well as liaison officer between the state organization and those of other states.

CALENDAR OF EVENTS

New York High Fidelity Music Show, Sept. 29-Oct. 3; New York Trade Show Building, New York, N. Y.
 Second International Exhibition of Industrial Electronics, Sept. 7-11; Swiss Industries Fair, Basel, Switzerland
 1965 Fall URSI Meeting (US National Committee of the International Scientific Radio Union, URSI), Oct. 4-6; Dartmouth College, Hanover, N. H.
 1965 Canadian Electronics Conference, Oct. 4-6; Automotive Bldg., Toronto, Ont.
 17th Annual Audio Engineering Society Convention, Oct. 11-15; Barbizon Plaza Hotel, New York, N. Y.
 1965 National Electronics Conference, Oct. 25-27; McCormick Place, Chicago, Ill.
 98th SMPTE Technical Conference, Oct. 31-Nov. 5; Queen Elizabeth Hotel, Montreal, Que.
 18th Annual Conference on Engineering in Medicine and Biology, Nov. 10-12; University of Pennsylvania and Sheraton Hotel, Philadelphia, Pa.
 Philco Service Training Meetings: Grand Island, Neb., Oct. 12, Holiday Inn; Omaha, Neb., Oct. 13, Holiday Inn; Des Moines, Iowa, Oct. 14, Holiday Inn; Portland, Me., Oct. 18, Philco Distributors, Inc.; Bangor, Me., Oct. 19, Utterback Corp.; Needham Heights, Mass., Oct. 20, Philco Distributors, Inc.; Providence, R. I., Oct. 21, Philco Distributors, Inc. For more detailed information, exact times and places, contact the local Philco distributor.

BRIEF BRIEFS

The National Aeronautics and Space Administration reports proudly that out of ten tries it has placed ten TIROS (Television Infrared Observation Satellites) in orbit. These satellites have provided extremely useful cloud-cover weather data.

According to an Atlanta pawnbroker, the "family jewels" have been replaced by the portable TV set as the item most likely to be pawned. The portable is usually a second set, and can be used to cover a small loan in emergencies, then reclaimed later, he says.

RADIO-ELECTRONICS

Go ahead and read the fine print! This is
ONE RECORD CLUB
WITHOUT RESTRICTIONS:

- Choose any LP, any label—no pre-selections!
- Buy 1 record or 100—no yearly quotas!
- Join once for a lifetime—no annual fees!
- Save at least 1/3—and much more on special sales!

This is the way you want it . . . a record club without restrictions. With the Record Club of America you can order any LP available in the entire Schwann Catalog (over thirty thousand selections) and save on every one! Nobody limits you to one label or two. Nobody sends you a card that means you get an unwanted record if you forget to return it. Nobody says you have to buy 4, 6, or 8 times a year. And nobody asks you to pay an annual membership fee. With Record Club of America you join once—and belong for a lifetime.

Here's HOW Record Club of America Works:

Fill out your Lifetime Membership application. Send it, with your check or money order for \$5 to Record Club of America. By return mail you'll receive your membership card guaranteeing you our regular discount of more than 1/3 off on every record you buy. That means you buy at dealer costs: all \$3.79 LP's at \$2.39; \$4.79 LP's at \$2.99 and \$5.79 LP's at just \$3.69. And our publication, *Disc.*, which regularly supplements Schwann's listings, keeps you informed of the Club's extra-saving "double discount" specials like those featured at right. *Disc.* also presents timely critical reviews by many of the nation's leading authorities. For your convenience we always enclose an order blank. Your order is processed the day we get it. Records come to you factory new. If not completely satisfactory they can be returned, immediate replacement guaranteed. Over 250,000 individual members and many of the nation's leading schools and libraries are today enjoying tremendous savings made possible through Record Club of America. Why not join them . . . and join us, today?

GIFT MEMBERSHIP SPECIAL!

Your membership entitles you to buy or offer gift memberships to friends, relatives and neighbors for only \$2.50 with full privileges. You can split the total between you—the original membership and one gift membership divided equally brings your cost down to \$3.75; one original membership and four gift memberships brings your cost down to \$3 each. Get a gang together—everybody saves!

© 1965 RECORD CLUB OF AMERICA, INC.

TYPICAL "DOUBLE DISCOUNT" SPECIAL SALE!	
LIST PRICE	OUR PRICE
3.79 Capitol, Columbia, RCA Victor Bestsellers	\$1.99
5.79 Westminster, Vox, Everest, RCA Victor Classical Albums	\$1.77
4.79 & 5.79 Audio Fidelity, Command Albums	\$1.99



FREE SCHWANN CATALOG

Over 30,000 selections from more than 300 manufacturers!
 CAPITOL • COLUMBIA • ANGEL
 RCA VICTOR • DECCA • MERCURY
 WESTMINSTER • DEUTSCHE GRAMMOPHON
 VOX • VERVE • LONDON
 ROULETTE • ABC PARAMOUNT
 ELECTROLA • AND HUNDREDS MORE

953-A

Record Club of America
 1285 Princess Street
 York, Pennsylvania 17405



Gentlemen:

Enclosed please find my check or money order for \$5.00 which will guarantee me Lifetime Membership in Record Club of America. I understand that I am under no obligation to purchase at any time, and that any purchases I do make will be at CLUB SAVINGS. I am free to choose any album as listed in the Schwann Record Catalog or Record Club of America's regular publication, *Disc.*

Add _____ Gift Memberships to my request. I enclose a check for _____ at \$2.50 each gift member, and have listed on attached sheet their names and addresses.

Signed _____

Address _____

City _____

State _____

Zip Code _____

Join the more than 250,000 happy members of
RECORD CLUB OF AMERICA

Circle 7 on reader's service card

**Discover the ease
and excitement of NRI's**

3 DIMENSIONAL METHOD

of ELECTRONICS TV-RADIO TRAINING

10 HOME-STUDY PLANS TO CHOOSE FROM

Ask men whose judgment you respect about NRI's three dimensional method of home-study training. Ask about the new, remarkable NRI Achievement Kit. Ask about NRI custom-designed training equipment, programmed for the training of your choice to make Electronics come alive in an exciting, absorbing, practical way. Ask about NRI "bite-size" texts, as direct and easy to read as 50 years of teaching experience can make them. Achievement Kit . . . training equipment . . . bite-size texts . . . the three dimensions of home-study training; the essentials you must have to make

learning easier, more interesting, more meaningful. You get them all from NRI.

Whatever your interest . . . whatever your need . . . whatever your education . . . pick the field of your choice from NRI's 10 instruction plans and mail the postage free card today for your free NRI catalog. Discover just how easy and exciting the NRI 3-DIMENSIONAL METHOD of training at home can be. Do it today. NATIONAL RADIO INSTITUTE, Electronics Division, Washington, D.C. 20016.

**BEGIN NOW AN ABSORBING
ADVENTURE—LEARN ELECTRONICS
THE EASY NRI WAY—MAIL CARD TODAY**

OUR 50TH YEAR OF LEADERSHIP



IN ELECTRONICS TRAINING

1 Start Fast with NRI's New Remarkable Achievement Kit

The day you enroll with NRI this new starter kit is on its way to you. Everything you need to make a significant start in the Electronics field of your choice is delivered to your door. It's an outstanding way of introducing you to NRI training methods . . . an unparalleled "first dimension" that opens the way to new discoveries, new knowledge, new opportunity. The Achievement Kit is worth many times the small payment required to start your training. No other school has anything like it. Find out more about the NRI Achievement Kit. Mail the postage-free card today.



2 NRI "Bite-Size" Lesson Texts Program Your Training

Certainly, lesson texts are a necessary part of any training program . . . but only a part. NRI's "bite-size" texts are simple, direct, well illustrated, and carefully programmed to relate things you read about to training equipment you build. Here is the "second dimension" in NRI's training method. Here are the fundamental laws of electronics, the theory, the training of your choice, presented in a manner you'll appreciate. And in addition to lesson texts, NRI courses include valuable Reference Texts related to the subjects you study, the field of most interest to you.



3 Custom-Designed Training Kits Make Learning Come Alive

Electronics becomes a clear and understandable force under *your* control as you get your hands on actual parts and build, experiment, explore, discover. Here is the "third dimension". . . the practical demonstration of things you read about in NRI texts. NRI pioneered and perfected the use of training kits to aid in learning at home in spare time. *Nothing is as effective as learning by doing.* NRI invites comparison with equipment offered by any other school, at any price. Prove to yourself what three-quarters-of-a-million NRI students could tell you . . . that you get more for your money from NRI than from any other home-study Radio-TV, Electronics school. Mail postage free card for your NRI catalog. (No salesman will call.)

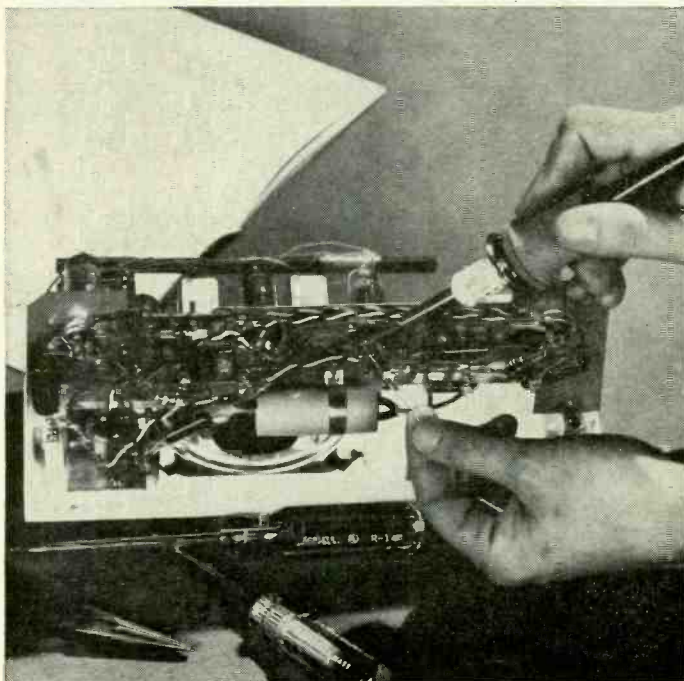

Announcing the new line of world-famous Schober Organ Kits...

ASSEMBLE YOUR OWN ALL-TRANSISTOR SCHOBER ELECTRONIC ORGAN



Designed by organists for organists, the new Schober Recital Organ actually sounds like a fine pipe organ. The newly-invented Schober Library of Stops provides you with an infinite number of extra voices so that you can instantly plug in the exact voices you prefer for a particular kind of music. Thirteen-piston, instantly resettable Combination Action makes the

All-New, All-Transistor Schober Recital Organ

- 32 voices, 6 couplers delight professional musicians... make learning easy for beginners.
- Standard console, pedals, keyboard correspond exactly to pipe-organ specifications.
- Printed circuit construction and detailed, illustrated instructions make for easy assembly... no previous experience necessary.
- Highly accurate church and theatre pipe tone in 5 pitch registers make every kind of organ music sound "right".
- Optional: Combination Action, Schober Reverbatape Unit, Repetitive Theatre Percussions.

Recital Organ suitable for the most rigorous church and recital work. The Schober Reverbatape Unit gives you big-auditorium sound even in the smallest living room. An instrument of this caliber would cost you \$5000 to \$6000 in a store. Direct from Schober, in kit form (without optional percussions, pistons, Reverbatape Unit) costs you only \$1500.



New, All-Transistor Schober Consolelette II

Here's the most luxurious "home-size" organ available today... with the same circuitry and musical design as the impressive Recital Organ. Full 61-note manuals, 17 pedals, 22 stops and coupler, 3 pitch registers, and authentic

theatre voicing leave little to be desired. Musically much larger than ready-made organs selling for \$1800 and more... the Consolelette II, in kit form, costs only \$850.



New Schober Spinet

The Schober Spinet is among the very smallest genuine electronic organs; only 39 1/4 inches wide, it will fit into the smallest living room or playroom—even in a mobile home. Yet it has the same big-organ tone and almost the

same variety of voices as the larger Consolelette II. The Schober Spinet far exceeds the musical specifications of ready-made organs selling for \$1100 and more. In easy-to-assemble kits... only \$550.

Schober Organ Kits are sold in the U.S. only by...

THE *Schober Organ* CORPORATION

43 West 61st Street, New York, N.Y., 10023

Dealers in Canada, Australia, Hong Kong, Mexico, Puerto Rico and the United Kingdom.

SEND FOR FREE SCHOBER BOOKLET

... Describes the exciting Schober Organ and optional accessories in detail; it includes a FREE 7-inch "sampler" record so you can hear before you buy.

Also available:
10-inch high-quality, long playing record... fully illustrates all three models with different kinds of music. Price is refunded with first kit purchase... \$2.00



The Schober Organ Corp., Dept. RE-39
43 West 61st St., New York, N.Y., 10023

Please send me, without cost or obligation, the Schober Organ Booklet and free 7-inch "sampler" record.

Enclosed find \$2.00 for 10-inch quality, LP record of Schober Organ music. (\$2.00 refunded with purchase of first kit.)

Name _____

Address _____

City _____ State _____ Zip No. _____

Circle 9 on reader's service card

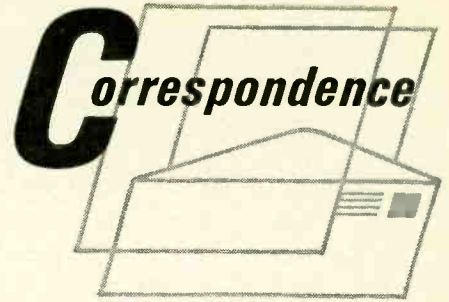

SET MANUFACTURERS— WHERE ARE YOU?

Dear Editor:

Re Service Clinic on HV regulators (July, page 20): the first paragraph sort of set me thinking. You're right. Every color set does indeed use the same old unimaginative 6BK4!

How in the world have set manufacturers overlooked a field as large as this in possibilities for new, high-cost, big-inventory tube types?

From past performance, we could reasonably have expected by now to have every possible combination of bases, envelope sizes and shapes, and heater voltages and currents.

Who slipped up? Where is the Compactron version listing for \$28 instead of \$8? Where are the 8-, 9-, 10-, 11-, 12- and 13-pin versions? Where is the 3.9642-volt-heater type? I haven't even seen one with the plate on the bottom and the cathode on the top.

Is American industry losing the ingenuity that put it where it is?

Or is this perhaps a sign of some Russian plot?

The *third* full-size tube caddy that currently rides around in the back of my service truck with the two others filled with once-in-a-lifetime replacement tubes still has a dozen or more empty spaces in it.

Don't you think this could stand some investigation?

AL YEAGER

Portsmouth, N. H.

CORRECTS PATENT MISUNDERSTANDING

Dear Editor:

As a patent attorney I was "shocked" to note that Sam Breskend, in his article on the Electronic Muscle Stimulator (June issue) used the term "skulduggery" to describe the mere act of sending to the Patent Office for copies of patents to ascertain what circuits were in use. Evidently Mr. Breskend misconceives the entire purpose of our patent system.

The word "patent" originally meant—and still does, in an alternative definition—"to be made open or public." Thus, when an invention is patented, the patent application is printed and copies

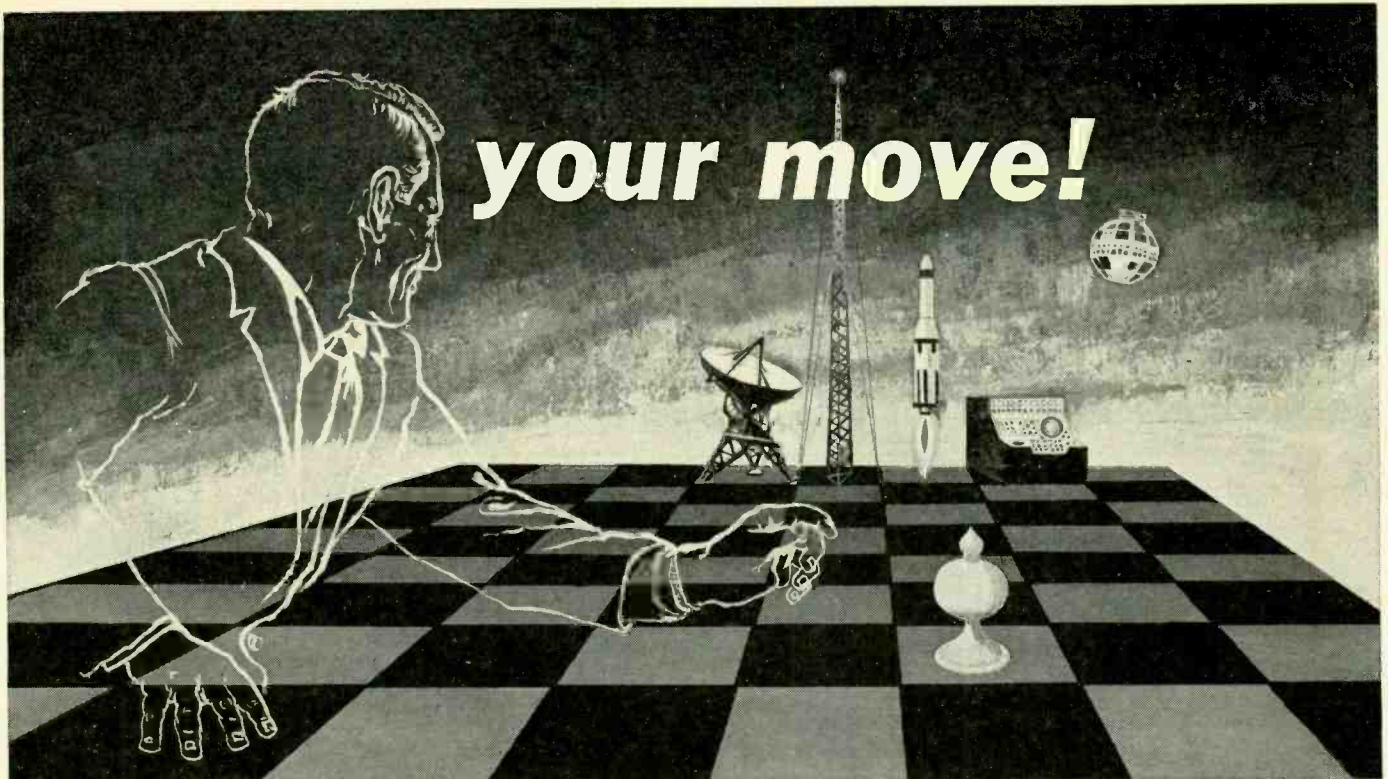

your move!

GRANTHAM SCHOOL OF ELECTRONICS makes your move easier.

Advancement in electronics depends on a solid *understanding* of basic principles — not merely a nodding acquaintance with them. If you are handicapped by a poor understanding of these vital “basics,” you need *the strong foundation training* offered by Grantham School of Electronics.

“Grantham,” year after year, continues to stand for **QUALITY** electronics training **IN A HURRY** — *quality*, in that the Grantham method promotes learning progress through understanding — *in a hurry*, in that the Grantham method leads to greater accomplishment in much less time than is required by conventional methods.

There is nothing fundamentally difficult about learning electronics, when the subject is approached by both teacher and student in a logical, learning-through-understanding manner. In the Grantham lessons, emphasis is placed on basic, easy-to-understand, descriptive discussions which teach through *reason* rather than through facts to be taken “on faith.” Grantham avoids the all-too-common practice of teaching *by rule* without any reason being given for the rule. Grantham seeks to have the student understand the reasons so well that rules are *not memorized by rote* but, rather, are *understood and therefore remembered*. This method makes learning more interesting and thus improves learning speed and retention.

Get complete details in our free 52-page booklet. Mail coupon, or telephone the school nearest you; phone numbers and addresses are listed below.

Prepare for Employment and/or Advancement in Electronics
by training with

GRANTHAM SCHOOL OF ELECTRONICS

Los Angeles Division 1505 N. Western Ave., Los Angeles, Calif. 90027	Phone: 469-7878
Seattle Division 408 Marion Street, Seattle, Wash. 98104	Phone: MA 2-7227
Kansas City Division 3123 Gillham Road, Kansas City, Mo. 64109	Phone: JE 1-6320
Washington Division 818 — 18th Street, N.W., Washington, D.C. 20006	Phone: 298-7460

(Mail in envelope or paste on postal card)

National Headquarters Office 54R
Grantham School of Electronics
 1505 N. Western Ave., Hollywood 27, Calif.

Gentlemen:

Please send me your FREE 52-page booklet,
“CAREERS IN ELECTRONICS.”

Name _____ Age _____
(PLEASE PRINT)

Address _____

City _____

State _____

I AM INTERESTED IN: HOME STUDY RESIDENT CLASSES

Circle 10 on reader's service card

are distributed to the public so that all may see the details of the invention. Of course a patent also confers a legitimate 17-year monopoly to the inventor or his assignee, but this monopoly is granted only if the inventor is willing to have the details of his invention made public. *The government grants a monopoly in exchange for the right to publish the details of the invention.*

What, then, is the purpose of publishing the details of an invention if only the inventor or his assignee can use it for the next 17 years? First, a patent owner rarely exercises his right to *bar* others from using his invention; others

are usually *licensed* to use the invention so that the patent owner can collect *royalties* from his licensees. Publishing, however, has several purposes. Another is to let the public know what is patented so that they will be able to know whether what they make, sell or use infringes another's patents. A third, but no less important purpose, is to give the public the benefit of others' new-found knowledge.

Thus while some patentees, such as those who manufacture electronic muscle stimulators, may not *wish* to have the details of their circuits published, they have implicitly consented to such publi-

cation, in exchange for patent protection. *It is perfectly legitimate for anyone to obtain copies of any patents.* Of course if anyone builds, sells or uses any patented invention without a license or permission from the patent owner, he will then be practicing "skulduggery".

D. R. PRESSMAN

Philadelphia, Pa.

THE ULTIMATE KICK

Dear Editor:

The editorial "Electronics and the Aged" in your June 1965 issue, was brought to my attention recently. As an example of the dangers in some of the suggestions you make in the later paragraphs, I would like to tell you of the experience of Kermit Sueker, late chief engineer of WCCO in Minneapolis.

Mr. Sueker was approached by an acquaintance who owned a mink farm near the city. In his efforts to speed up the process of getting out a new mink mutation, he asked Mr. Sueker for some help in setting up a process of artificial insemination, using a prod and a low-voltage pulsating current to induce what you refer to as "electro-ejaculation."

Having nothing to go on but the experience of dairy breeders, Mr. Sueker put his slide rule to work establishing proportions between the mass of a bull's body and that of a mink, rectal measurements, etc. He came up with a blunt darning needle, a transformer and some specifications on voltage and frequency of current alternation.

Came the day to try the new device: the men each put on heavy gloves, inserted the probe, turned on the current, and the male mink—with a blissful expression on his face—curled up his toes and died.

The moral to all of this, I think, is: it's a fine way to go!

ROBERT P. SUTTON
Vice President
and General Manager

KNX Radio
Los Angeles, Calif.

EXPLAINS EUROPEAN SEMICONDUCTOR CODING

Dear Editor:

Here in England RADIO-ELECTRONICS represents the best value in radio magazines. There is no other publication so packed full of circuits and news.

I have one criticism of American transistor coding. It gives no indication of the usage of the device. The current European coding tells whether the device is for domestic or industrial uses and whether it is a germanium or silicon.

The code consists of two letters followed by three figures or a letter and two figures.

First letter—semiconductor material
A Germanium

NOT JUST HORNS NOT JUST CONES

OXFORD

HAS THE FULL LINE

Model
OP-6



to Supply Commercial
Sound Needs...

Model
DVC-8J4



Model
OH-10



From the OP-6 & OP-8 paging and talkback horns and the OH-10 outdoor high fidelity system, which changed the outdoor speaker market in 1964, to the startling new DVC-8H4 and DVC-8J4 units with two separate voice coil winding, providing immediate access to the speaker, Oxford is the one source best qualified to supply all your speaker needs.

Our line also includes intercom speakers, public address speakers, all-weather cones, shallow ceramic magnet units, and the "Specialist Series." The Specialists (which includes models DVC-8H4 and DVC-8J4) are a series of popular 8-inch speakers that have been prepared for "instant use" by the commercial sound installer, with factory installed transformers and bulk packaging.

It makes good sense to use the line that is orientated toward the commercial sound installer by both design and marketing. For more information on the OXFORD, line, write for complete catalog.

**OXFORD
TRANSDUCER
COMPANY**

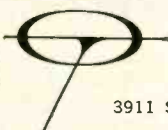

A Division of Oxford Electric Corporation

3911 South Michigan Avenue • Chicago, Illinois 60653

Circle 11 on reader's service card

Congress DIDN'T GO FAR ENOUGH!

PUBLIC LAW 87-529; 76 STAT. 150

[H. R. 8031]

An Act to amend the Communications Act of 1934 in order to give the Federal Communications Commission certain regulatory authority over television receiving apparatus.

Be it enacted by the Senate and House of Representatives of the United States of America in Congress assembled, That:

Section 303 of the Communications Act of 1934 (47 U.S.C. 303)³¹ is amended by inserting at the end thereof the following:

“(s) Having authority to require that apparatus designed to receive television pictures broadcast simultaneously with sound be capable of adequately receiving all frequencies allocated by the Commission to television broadcasting when such apparatus is shipped in interstate commerce, or is imported from any foreign country into the United States, for sale or resale to the public.”

Sec. 2. Part I of title III of the Communications Act of 1934 is amended by inserting at the end thereof a new section as follows:

THEY SHOULD HAVE ALSO REQUIRED...

“—that all 82-channel television receivers* must use an 82-channel television antenna.”

Of course, you can't take the law into your own hands—but you *can* take advantage of today's ready-made opportunities to sell an 82-channel antenna with each 82-channel TV set.

Our Antenna Research Laboratories in Champaign, Illinois knew what they were doing when they teamed the acclaimed Log Periodic concept of the University of Illinois Antenna Research Laboratories with our new antenna design advance—the capacitor-coupled electronic dipole. Proof is the fact that the JFD LPV-VU is America's No. 1 82-channel TV/FM antenna!

Who says you can't have everything

you want in a TV antenna—VHF?... UHF?... FM Stereo?—with a *single* down-lead to boot!

MOST EFFICIENT PERFORMANCE EVER ON VHF, UHF, FM/STEREO FROM ONE ANTENNA USING ONE DOWN-LEAD!

- *Cap-electronic* dipole design makes more elements resonate on channels 7 to 13 with a corresponding increase in gain.
- *Higher mode* operation in UHF band achieves higher gain on channels 14 to 83—and FM stereo.
- *Narrower beamwidths* . . . higher front-to-back ratios step up ghost rejection . . . intensify color.
- *Patented frequency independent* design maintains peak perform-

ance characteristics regardless of channel or band tuned.

- Includes 3-way splitter so single down-lead can be tied into individual VHF, UHF and FM system inputs.

REMEMBER — AN 82-CHANNEL TV SET IS NOT AN 82-CHANNEL TV RECEIVER UNLESS IT HAS AN 82-CHANNEL TV ANTENNA!

*Lest we forget — every *color* set is also an *82-channel* set requiring a color-perfect antenna. In fact, many color TV shows are broadcast on UHF channels.

JFD

SEE YOUR DISTRIBUTOR OR
WRITE FOR BROCHURE 806



JFD LPV-VU LOG PERIODICS for channels 2 to 83 and FM/Stereo.

Licensed Under One or More of U.S. Patents 2,958,081; 2,985,879; 3,011,168; 3,108,280; 3,150,376 and Additional Patents Pending in U.S.A. and Canada. Produced by JFD Electronics Corporation under exclusive license from the University of Illinois Foundation.

Circle 12 on reader's service card

www.americanradiohistory.com

JFD ELECTRONICS CORPORATION

15th Ave. at 62nd Street, Brooklyn, N.Y. 11219

JFD Electronics-Southern Inc.

Oxford, North Carolina

JFD International

64-14 Woodside Ave., Woodside 77, N.Y.

JFD Canada, Ltd.

51 McCormack Street, Toronto, Ontario, Canada

- B Silicon
R Compound materials, like cadmium sulfide

Second letter

- A Low-power diode
C Low-power audio transistor
D High-power audio transistor
E Tunnel diode
F Low-power rf transistor
L High-power rf transistor
P Photodiode, phototransistor, light-dependent resistor
R Controlled rectifier—low power
S Switching transistor—low power
T Controlled rectifier—high power

- U Switching transistor—high power
Y Diode—high power
Z Zener diode

Third, fourth and fifth characters

- 3 figures—device for domestic use, e.g., radio sets
1 letter, 2 figures—device for industrial use, e.g., pulse equipment

Examples

- AF117 Germanium rf, domestic
BLY10 Silicon high-power rf, industrial
BZY88 Silicon Zener diode, industrial

Although I would like to build many

of the circuits in RADIO-ELECTRONICS, I find that I am limited to circuits where I can easily determine what type of transistor is required. I think that it would be a good idea if a rough equivalents list could be produced.

D. J. TAYLOR, G6SDB/T
Dudley, Worc., England
P.S.—The 0C71, 0C44, etc., the 0A5, 0A91 and the other device numbers which do not comply to the coding were set up under an old system and have survived.

SHUTTER-CHECKER NOTE

Dear Editor:

Please warn your readers that Elliott McCready's shutter checker (page 38, May 1965) will not work for the higher speeds (above X-sync) of focal-plane shutters. Almost every interchangeable-lens 35-mm camera has such a shutter. Low speeds are far more reliable than high speeds, and rarely need checking.

PHILIPPE RANGER

Montreal, Que.

The author replies:

Tests I made after receiving this note indicate that Mr. Ranger is correct. At speeds over X-sync, which is a constant speed of about 1/60 second, a camera with a focal plane shutter gives an erroneous indication. This is probably due to the fact that the shutter "sweeps" the film, as compared to the action of the ordinary camera shutter. Even so, there is no reason that this effect couldn't be compensated for by using a correction factor based on the size of the shutter opening and the overall size of the film.

Checks with several camera repair shops by myself and the Technical Editor of RADIO-ELECTRONICS, indicate that slower shutter speeds are apt to give more trouble than the faster speeds.

ELLIOTT A. MCCREADY

END

Jackson ... IT'S THE FINEST

Color Keyed

Model 825 Picture Tube Tester/Booster



the most versatile and accurate of all CRT testers... for all

BLACK/WHITE and COLOR PICTURE TUBES...

look at all the valuable and profitable functions

Tests for continuity, leakage, emission, picture tube cut-off and life-expectancy • Removes shorts • Welds cathode • Boosts picture tube back to life

look at these brilliantly engineered Jackson features

12 separate heater voltages including color • Line indicator control for accurate voltages • Grid guard limits peak current for protection of picture tube • Checks each color gun separately • Plug-in socket cable for easy replacement or repair • Separate variable voltages applied to G1-G2 of picture tube

look at all these convenient operational features

Color keyed—push buttons for ease and speed in testing • FM tuning eye...no separate lights to interpolate • Angled view roll chart on panel...tube set-up information at your fingertips • Easy to keep up-dated

Size: 14¾" Wx13½" Dx5¾" H.
Wt.: 13 lbs. 3 oz. Dealer Net **\$119.95**

See your Jackson distributor, or write for catalog

JACKSON ELECTRICAL INSTRUMENT COMPANY
124 McDonough Street, Dayton 2, Ohio
Export: Mogan Exporting Corporation
458 Broadway, New York 6, N.Y.

IF IT'S A JACKSON...IT'S THE FINEST

Circle 13 on reader's service card

37

You can obtain, free of charge, more information or literature about products and services advertised or editorially featured in this issue of

RADIO-ELECTRONICS.

Simply circle the appropriate numbers on the Readers' Service Card bound into this copy and mail today!

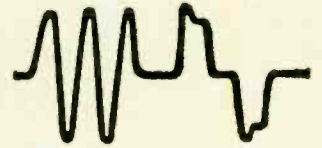

Meet a new kind of Capacitor



Once in a while something new comes along that seems almost too good to be true. We've just come up with one of these. It's the Mallory MTA molded electrolytic capacitor. And it not only has good quality and good performance but its price is so low that it doesn't seem possible it could be made by a reputable U. S. manufacturer. But it's made by Mallory in our new Glasgow, Kentucky plant. So you know you can rely on it for famous Mallory quality.

What makes it unusual is a different kind of construction, worked out by Mallory capacitor specialists. Its moisture-proof plastic case is molded *in one piece* around the capacitor element. There are no seals or gaskets. Moisture can't get in, electrolyte can't leak out—no matter how much mechanical abuse and thermal cycling you give it.

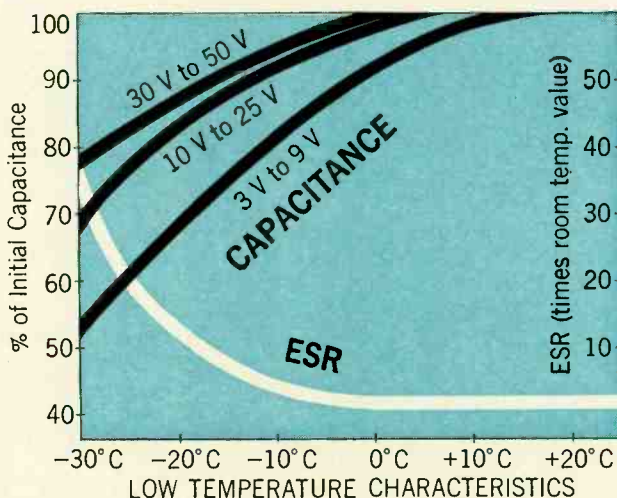

The result: life, reliability, and temperature stability are far superior to cardboard case capacitors and other plastic-case types. Consistently better than imported types. And even better than many metal case tubular capacitors which cost one-third more! Look at the temperature stability test chart, for instance. This is excellent performance for a low-cost miniature electrolytic. So good, in fact, that we have now rated the MTA for -30°C to $+85^{\circ}\text{C}$.

As for reliability, here are some figures from our test lab that should reassure anyone who worries about consistent quality (and who doesn't?). In over one million piece-hours of life test at 85°C , there hasn't been a single failure. At 65°C , we've had only *one* failure in $2\frac{1}{2}$ million piece-hours.

Standard MTA Values Available			
	Case Size	Volts WVDC	MFD
D	$\frac{5}{16}'' \times \frac{3}{4}''$	3 to 50	60-8
E	$\frac{3}{8}'' \times 1''$	3 to 50	175-20
F	$\frac{1}{2}'' \times 1\frac{3}{8}''$	3 to 50	600-80

You'll recognize the MTA by its bright white plastic case. Your Mallory distributor has them in stock for your use in replacement work and in experimental circuits, in handy two-pack blister cards. Mallory Distributor Products Company, a division of P. R. Mallory & Co. Inc., P. O. Box 1558, Indianapolis, Indiana 46206.

Circle 14 on reader's service card

You can earn more money if you have an FCC License

FCC Form 756 A

The United States of America

NUMBER
P1-20-490

FEDERAL COMMUNICATIONS COMMISSION

RADIO TELEPHONE OPERATOR LICENSE

FIRST CLASS
(General Radiotelephone Certificate)

This certifies that _____ **TOMMY WILLIS DUFFY**

IS A LICENSED RADIO OPERATOR, AUTHORIZED, SUBJECT TO ANY SPECIAL ENDORSEMENT PLACED HEREON, TO OPERATE THE CLASSES OF LICENSED RADIO STATIONS FOR WHICH THIS CLASS OF LICENSE IS VALID UNDER THE ORDERS, RULES AND REGULATIONS OF THE FEDERAL COMMUNICATIONS COMMISSION, ANY STATUTE OF THE UNITED STATES AND ANY TREATY TO WHICH THE UNITED STATES IS A PARTY.

THIS LICENSE IS GRANTED UNDER THE AUTHORITY OF THE COMMUNICATIONS ACT OF 1934 AS AMENDED, AND THE TERMS AND CONDITIONS THEREOF AND OF ALL LEGISLATIVE ACTS, EXECUTIVE ORDERS, AND TREATIES TO WHICH THE UNITED STATES IS SIGNATORY, AND ALL ORDERS, RULES AND REGULATIONS OF THE FEDERAL COMMUNICATIONS COMMISSION, WHICH ARE BINDING UPON RADIO OPERATORS, ARE MADE A PART HEREOF AS THOUGH SPECIFICALLY SET OUT IN FULL HEREIN.

NEITHER THIS LICENSE NOR THE RIGHT CERTIFIED TO HEREIN SHALL BE ASSIGNED OR OTHERWISE TRANSFERRED TO ANY OTHER PERSON.

PLACE AND DATE OF ISSUANCE: BUFFALO, NEW YORK SEPTEMBER 11, 1963

DATE AND TIME OF EXPIRATION: SEPTEMBER 11, 1968 AT THREE O'CLOCK A. M., EASTERN STANDARD TIME.

SPECIAL ENDORSEMENT: SHIP RADAR ENDORSEMENT - SEPTEMBER 11, 1963 - BUFFALO, NEW YORK

[Signature]
ISSUING OFFICER
Federal Communications Commission.

[Signature] *[Signature]* *[Signature]*
(Licensee) (Issuing Officer) (Secretary)

NOT VALID UNTIL SIGNED

Employers are paying good money for men holding FCC tickets. Read how to get yours:

When you hold a Commercial License issued by the FCC (Federal Communications Commission) you have written proof that you know and understand basic electronic theory and fundamentals. It's worth plenty . . . particularly to companies on the lookout for qualified electronics technicians. Here's how one of the country's leading office machine manufacturers rates men with FCC Licenses:

"An FCC License is an asset to any man looking to enhance his career in the field of electronics. At our Company, a licensed man is well-rewarded because an FCC License attests to his knowledge of electronics theory . . ."

Thousands of employers will tell you the same thing. Licensed men get the good jobs. They make more money

. . . move ahead faster . . . enjoy exciting, challenging work. What's more, they're needed badly in every field of electronics. Industrial electronics. Radio-TV Broadcasting. Aerospace. Electronics Servicing . . . including mobile and marine radio *plus* CB.

Yes . . . your opportunities are unlimited once you're carrying that FCC Commercial Ticket. AND CLEVELAND INSTITUTE OF ELECTRONICS CAN GET ONE FOR YOU! On the facing page, read how four ambitious men just like you have cashed in on CIE's sure-fire FCC Licensing Program. Read about CIE's exclusive money-back offer. And then send in the postage paid reply card. CIE will quickly send you complete FREE information. You will soon be on *your* way to a Commercial FCC License and the many rewards that go with it!

These CIE men have good jobs

(they have Commercial FCC Licenses)



Matt Stuczynski, Senior Transmitter Operator, Radio Station WBOE. "I give Cleveland Institute credit for my First Class Commercial FCC License. Even though I had only 6 weeks of high school algebra, CIE's AUTO-PROGRAMMING teaching method makes electronics theory and fundamentals easy. After completing the CIE course, I took and passed the 1st Class Exam. I now have a good job in studio operation, transmitting, proof of performance, equipment servicing. Believe me, CIE lives up to its promises!"



Ted Barger, Electronic Technician, Smith Electronics Co. "I've been interested in electronics ever since I started operating my own Ham rig (K8ANF). But now I've turned a hobby into a real interesting career. Cleveland Institute of Electronics prepared me for my Commercial FCC License exam . . . and I passed it on the first try. I'm now designing, building and testing all kinds of electronic equipment . . . do a lot of traveling, too. It's a great job . . . and thanks to CIE and my FCC License, I'm on my way up."



Chuck Hawkins, Chief Radio Technician, Division 12, Ohio Dept./Highways. "Cleveland Institute Training enabled me to pass both the 2nd and 1st Class License Exams on my first attempt . . . even though I'd had no other electronics training. (Many of the others who took the exam with me were trying to pass for the eighth or ninth time!) I'm now in charge of Division Communications and we service 119 mobile units and six base stations. It's an interesting, challenging and extremely rewarding job. And incidentally, I got it through CIE's Job Placement Service . . . a free lifetime service for CIE graduates."



Glenn Horning, Local Equipment Supervisor, Western Reserve Telephone Company (subsidiary of Mid-Continent Telephone Company). "There's no doubt about it. I owe my 2nd Class FCC License to Cleveland Institute. Their FCC License Program really teaches you theory and fundamentals and is particularly strong on transistors, mobile radio, troubleshooting and math. Do I use this knowledge? You bet. We're installing more sophisticated electronic gear all the time and what I learned from CIE sure helps. Our Company has 10 other men enrolled with CIE and take my word for it, it's going to help every one of them just like it helped me."

FCC LICENSE WARRANTY

A CIE FCC License Course will quickly prepare you for a Commercial FCC License. If you don't pass the FCC exam . . . on the first try . . . after completing your course, CIE will refund all your tuition. You get an FCC License . . . or your money back!

Two out of three men who took the 1st Class Commercial FCC License exam in 1964, failed.

Nine out of ten CIE-TRAINED men who take this exam, pass . . . the very first try!

And that's why CIE can back their courses with the warranty you see at the left. CIE-trained men know their stuff . . . because CIE AUTO-PROGRAMMED Home Study works!

Get started now. Send postage-paid reply card for free information about a plan that gets you an FCC License or costs you nothing!

 **CIE**

Cleveland Institute of Electronics

1776 East 17th Street, Dept. RE-9, Cleveland, Ohio 44114

SERVICE CLINIC

By JACK DARR Service Editor

TUNER REPAIRS

Includes ALL parts (except tubes)...
ALL labor on ALL makes for complete overhaul.

\$950

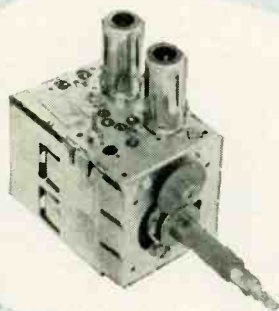

FAST, 24-HOUR SERVICE
with FULL YEAR WARRANTY

Sarkes Tarzian, Inc., largest manufacturer of TV and FM tuners, maintains two completely-equipped Service Centers, offering fast, dependable tuner repair service. Tarzian-made tuners received one day will be repaired and shipped out the next. More time may be required on other makes. Every channel checked and realigned per manufacturer's specs. Tarzian offers full, 12-month guarantee against defective workmanship and parts failure due to normal usage. Cost, including all labor and parts (except tubes), is only \$9.50 and \$15 for UV combinations. No additional costs. No hidden charges. You pay shipping. Replacements at low cost are available on tuners beyond practical repair.

Always send TV make, chassis and Model number with faulty tuner. Check with your local distributor for Sarkes Tarzian replacement tuners, parts, or repair service. Or, use the address nearest you for fast factory repair service.



SARKES TARZIAN, INC.
TUNER SERVICE DIVISION

Dept. 200
537 South Walnut St.,
Bloomington, Indiana
Tel: 332-6055

Dept. 200
10654 Magnolia Blvd.,
North Hollywood, Calif.
Tel: 769-2720

MANUFACTURERS OF TUNERS, SEMICONDUCTORS,
AIR TRIMMERS, FM RADIOS, AM-FM RADIOS,
AUDIO TAPE and BROADCAST EQUIPMENT

Setting Up A

Master Antenna System

It's fairly easy. You have a certain number of TV stations, with a given signal level up on the roof from each. The actual signal level is found by measuring it with a field-strength meter. The problem is to get these signals down to the TV sets, with a plentiful signal for each set. Now, it's simple arithmetic.

Let's say we have a signal level of 100 μV on each channel. We want a minimum signal of 500 μV on the line to each set, a voltage ratio of 1:5. To simplify things, let's convert this to db, since all our hardware (cable, amplifiers, splitters) is rated in db (voltage).

The distribution system will have to be made up with coaxial cable, for several reasons. For one, we can't allow any radiation of signals; two, we can't have any noise or signal pickup by the cable itself. The most common sort is 72-ohm, and this comes in several types. The bigger, low-loss cables are expensive, so we generally use the smaller, higher-capacitance cable and make up the extra loss with the amplifiers. As long as we can get there with enough signal, we don't care how!

All coax has a certain loss. The bigger the cable (lower capacitance) the lower this is. However, at a given frequency, each cable has a fixed amount of loss per foot. You'll find this in coax tables as so many db per 100 feet at a given frequency. RG-59/U, for example, has a loss of 3.8 db at 100 mc. To find the total loss, we multiply the total footage by the loss per foot. Let's take a nice round figure and call our cable loss 100 db.

Now, we need a boost of 5 times in the signal voltage from our antennas. This is 14 db. So, let's put in separate single-channel "head-end" amplifiers at each antenna; these need a gain of 14 db each. Now, we're back to our zero-level (which, in this case, is 500 μV). We have to "hold" this through the

whole system.

Fig. 1 shows how. Starting at the antennas, we go through the head-end amps, then into a mixer. These are usually broad-band amplifiers with gain, but we'll call the gain 0 db here. Now, we go through a 25-db loss in the first cable run. So, we put in a broad-band amplifier with 25-db gain and we're back in business again! The next run also has 25-db loss, so in goes another 25 db of gain in the next line amplifier, and so on and on far down into the elevator shaft.

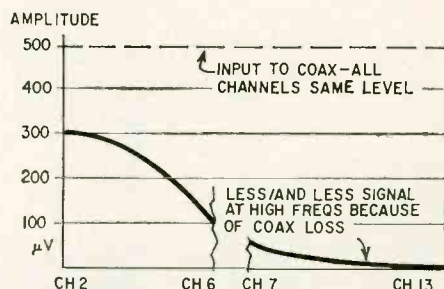
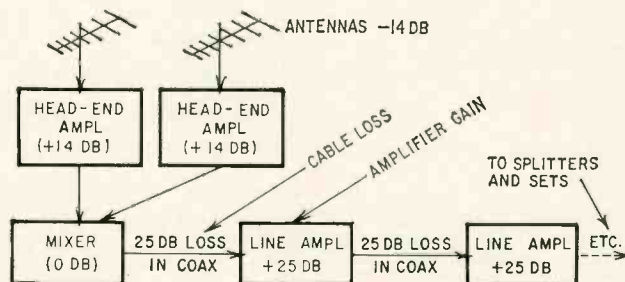

Fig. 2—Losses increase with frequency on coaxial cable.

Now the complications set in. Line losses are linear if we consider only one frequency. But we've got to amplify a whole lot of frequencies over a band between 54 and 216 mc. The all-channel loss characteristic of any piece of coax looks something like Fig. 2; if we feed in signals all at the same level, we get out something that looks like a depressed ski jump.

Fortunately, there is a simple way to compensate for this. The loss is reasonably linear with increasing frequency. The line amplifiers used are very broad-band types. We can align these amplifiers to make up for the difference in loss in the cable. Fig. 3 shows how. We set them up so that they have a very high gain on high-band channels, and this slopes gradually down to the lowest gain end, at channel 2. By careful adjustment, we can make the output response curve of the line amplifier

Fig. 1—A basic MATV layout. Head-end amplifiers raise signal to desired level. Line amplifiers overcome losses in distribution cable.





B&K MODEL 970 RADIO ANALYST

SERVICE AM & FM AUTO AND TRANSISTOR RADIOS AT A PROFIT!

NEW!

Jobs that used to be unprofitable now go so quickly that you can make good money handling them! There are millions of auto radios and transistor radios in the field—portables, auto and table models, plus hi-fi and communications equipment. Instead of turning them away, you can turn them into money-makers with the B&K Model 970 Radio Analyst.

The 970 is effective because it's *accurate* and *complete*. Using the famous B&K signal injection technique, this all-in-one instrument provides the required dc power, lets you test power and signal transistors in and out of circuit; generates RF and audio signals, and includes a rugged, accurate VOM. Four functions in one compact package—with solid state reliability, B&K professional quality.

LOW INVESTMENT—QUICK RETURN

See your B&K Distributor or write for Catalog AP22-R

Net \$199⁹⁵



B & K MANUFACTURING CO.
DIVISION OF **DYNASCAN CORPORATION**
1801 W. BELLE PLAINE AVE. • CHICAGO, ILL. 60613

Export: Empire Exporters, 123 Grand St., New York 13, U.S.A.

Circle 17 on reader's service card

FEATURES:

BUILT-IN POWER SUPPLY

Auto Radios—High current, low-ripple, for transistor, hybrid, and vibrator types.

Transistor Portables—1½ to 12 volts for battery substitution—plus separately variable voltage tap for bias.

QUICK AND ACCURATE TESTING OF POWER AND SIGNAL TRANSISTORS

In-Circuit—stage by stage DC signal injection and sensitive metering of power supply current.

Out-of-Circuit—Direct Beta and Leakage meter scale readings. Easy balancing or matching.

VERSATILE SIGNAL GENERATORS

RF Generators—provide broadcast and IF frequencies for both AM and FM bands.

Audio Generator—for AM or FM modulation of the RF signals, and for troubleshooting audio circuits.

RUGGED VOM

Volt-OHM-Milliammeter—with rugged, taut band meter—provides correct ranges for easy, fast servicing of all home and auto radios, as well as transistor portables.

ATTENTION! CB OPERATORS

save on citizens radio equipment

Discontinued Models From International Radio Exchange

Select that extra transceiver for mobile or base installation, or equip a new station. Our stock includes International types as well as other makes.

Write Today for A
Complete List of
Equipment in Stock



RADIO EXCHANGE
18 NO. LEE, OKLA. CITY, OKLA. 73102
Division Of International Crystal Mfg. Co.
Dealing In Used Citizens
Radio Equipment



Circle 18 on reader's service card

NOW! Solve Electronics Problems fast with New Patented Slide Rule.

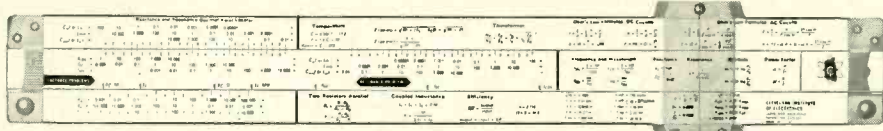

That's right! This amazing new Electronics Slide Rule will save you time the very first day you use it. It's a patented, all-metal 10" rule that features special scales for solving reactance, resonance, inductance and circuitry problems . . . an exclusive "fast-finder" decimal point locator . . . widely-used formulas and conversion factors for instant reference. And there's all the standard scales you need to do multiplication, division, square roots, logs, etc.

Best of all, the CIE Electronics Slide Rule comes complete with an Instruction Course

of four **AUTO-PROGRAMMED** lessons. You'll quickly learn how to whip through tough problems in a jiffy while others plod along the old-fashioned "pad and pencil" way.

Electronics Slide Rule, Instruction Course, and handsome, top-grain leather carrying case . . . a \$50 value for less than \$20. Send coupon for **FREE** illustrated booklet describing this Electronics Slide Rule and Instruction Course and **FREE** Pocket Electronics Data Guide. Cleveland Institute of Electronics, 1776 E. 17th St., Dept. RE-115, Cleveland, Ohio 44114.

*TRADEMARK

GET BOTH FREE!

ELECTRONICS

SLIDE RULE

Send coupon today →

Cleveland Institute of Electronics

1776 E. 17th St., Dept. RE-115, Cleveland, Ohio 44114

Send **FREE** Electronics Slide Rule Booklet. Special Bonus: Mail promptly and get **FREE** Pocket Electronics Data Guide too!

NAME _____ (Please Print)

ADDRESS _____ COUNTY _____

CITY _____ STATE _____ ZIP _____

A leader in Electronics Training... since 1934

Circle 19 on reader's service card

equal and opposite to the loss curve of the coax, and compensate for the losses. Now we come out with a flat response over the whole band, as shown. (Not quite *that* flat, of course, but close to it!)

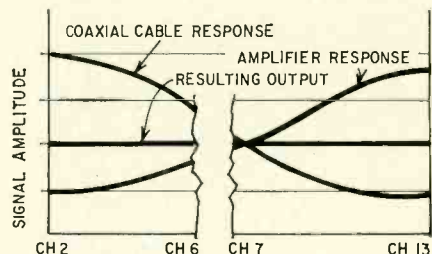

Fig. 3—Shaping amplifier response to inverse of transmission line's gives system flat overall response.

Line splitters, tapoffs and other hardware used in an installation are *passive* elements. Many of these have very small insertion losses, and can be disregarded. Others have intentional losses to prevent interaction between sets, ghosting and similar troubles. These losses, expressed in db, can be added just as simply, and the amplifier gain set up to take care of them.

So, that's about all there is to it. Careful selection of high-quality equipment, and the proper installation techniques, will produce a master-antenna system that can be installed and maintained at a neat profit for all concerned! Community-antenna systems (CATV) are exactly like this, on a bigger scale.

Red-hot HV rectifier, RCA CTC11

The plate of the 3A3 rectifier glows red, after about 30 seconds, in an RCA CTC11 color TV I got in the other day. Dim raster fills out the screen, no control of focus. Current on the 6BK4 is way too high. Voltages on grid and

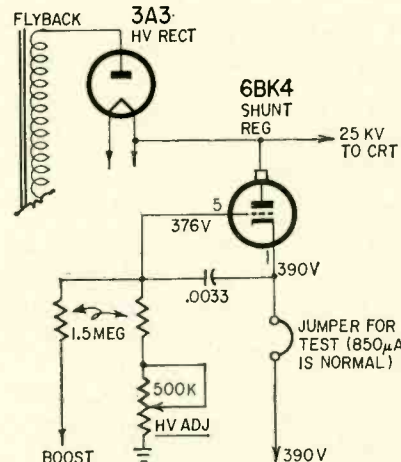

Remove jumper and insert meter to measure regulator current.

10 facts you should know about color-bar generators

If you are going to buy a color-bar generator—or even if you already own one—here are several facts you should know.

While other types of test instruments may lack one or more features, they may still be useful in skilled hands—provided the user is aware of their shortcomings and provided he has other means of determining what he must know.

This is not true of a color-bar generator.

A color-bar generator should allow you to walk away from an adjusted receiver knowing that the owner can turn it on and receive color broadcasts in full-fidelity color and sound.

Not all color-bar generators can give you this assurance.

Let's talk facts.

FACT NO. 1: *A gated-rainbow type generator is accepted as the standard of the service industry*

You do not need fully saturated NTSC colors to achieve perfect adjustment any more than you need an FCC-type broadcast signal for tuner and if-amplifier alignment. The gated-rainbow type signals are used by virtually all TV manufacturers in establishing service procedures for their sets.



Gated rainbow color-bar pattern

Urgent service needs for a trustworthy color-signal source were met years ago when RCA introduced the gated-rainbow system.

Today, this basic system is used in nearly all service-type color-bar generators. The waveforms and procedures in nearly all color-TV service notes are based on this system.

FACT NO. 2: *All gated-rainbow type generators are not alike*

In spite of their basic circuit similarities, available models differ in their features, accuracy, and ultimate usefulness. Some of these differences are critical.

FACT NO. 3: *The offset subcarrier oscillator must be controlled within a few cycles of its true frequency*

This oscillator controls the phase angles (hues) of the color-bar pattern. It is the heart of the color-bar generator.

The subcarrier oscillator should be within ± 20 cps of its fundamental frequency of 3.563795 megacycles. In the crystal-controlled RCA WR-64B Color-Bar/Dot/Crosshatch Generator, this deviation is kept well within the ± 20 cps limit.

FACT NO. 4: *Provision must be included to prevent the subcarrier oscillator from drifting off frequency*

The subcarrier oscillator must not only be accurate when the instrument is new—it must

stay accurate. Top-quality components minimize undesirable frequency changes.

Check, for instance, the trimmer capacitor used in the 3.56-Mc subcarrier oscillator. You'll find a piston-type ceramic capacitor—not a flat mica type—in the RCA WR-64B.

FACT NO. 5: *The generator must have an rf-sound carrier to assure proper setting of the fine-tuning control*

Unless your color-bar generator has this essential feature, it may produce a perfect color-bar pattern on the receiver, but at the wrong setting of the receiver fine-tuning control. In such cases, the receiver may not correctly reproduce a color program.

The WR-64B has this necessary feature. With it, you can accurately set the fine-tuning control before making color adjustments. In the WR-64B the rf-sound carrier is also crystal-controlled.

FACT NO. 6: *The rf picture carrier must be exactly on frequency to assure that the color subcarrier is correctly placed in the receiver bandpass*

Drift, faulty adjustment, or aging of components in the rf oscillator section can move the generator picture carrier off frequency. This shift, in turn, will also move the color subcarrier signal away from its correct position in the receiver bandpass. In some receivers, this shift will affect accuracy of color-circuit adjustments.

A separate crystal-controlled oscillator is used in the WR-64B to keep the picture exactly on frequency.

FACT NO. 7: *The axes of the output color-bar pulses should lie on the zero axis—and not on elevated brightness pedestals*

Elevated pulses necessitate use of an oscilloscope for accurate setting of receiver phasing. A generator having zero-axis color-bar pulses, such as the WR-64B, does not require use of an oscilloscope for checking phasing in the customer's home.

FACT NO. 8: *The generator should not require frequent adjustment of internal counter circuits*

All color-bar generators contain circuits which develop vertical and horizontal sync, and dot-and-bar-pattern signals, by dividing or counting down from a higher frequency: usually 189 Kc. If one of these circuits is unstable, the patterns can jitter, ripple, jump sync or contain the wrong number of dots or bars.

Conventional R-C circuits are used in the counters of most generators. But the RCA WR-64B uses inherently stable iron-core in-

ductors in its counters, thereby assuring long-term counter-circuit stability.

FACT NO. 9: *The proper way to check receiver color performance is to feed the generator signal into the antenna terminals*

Color performance depends on overall receiver condition—not on that of a single section alone. A color-test signal fed directly into the video amplifier—rather than through the antenna terminals—will not provide a proper check of the complete receiver. The only method you should use in adjusting the receiver, therefore, is the rf-signal-input method—the method provided by the RCA WR-64B.

FACT NO. 10: *There is no "best" dot size or bar width for convergence adjustments*

Generator dot size or bar width has no significance for convergence adjustments.

Veteran technicians, however, have found that very small dots or thin bars are difficult to use under average lighting conditions. If receiver brightness is turned up to overcome this handicap, blooming will result. Proper convergence cannot be achieved under this abnormal condition.

The dot and bar size of the WR-64B is small enough to permit exact, speedy adjustment, and large enough to be useful under average lighting conditions.

These are ten specific facts you should know about color-bar generators. They add up to this

FACT: *The new RCA WR-64B has all the features you need for complete color-circuit adjustment*

It's the one color-bar generator that meets all servicing requirements—from the company that pioneered and developed the color-TV system now in universal use: RCA!

Order it today from your local Authorized RCA Test Equipment Distributor.



\$189.50* *Optional distributor resale price. May be slightly higher in Alaska, Hawaii and the West. Prices subject to change without notice.

RCA ELECTRONIC COMPONENTS AND DEVICES,
HARRISON, NEW JERSEY



The Most Trusted Name in Electronics

Circle 20 on reader's service card

plate of the 6BK4 are the same: 380.—C.Y., Myrtle Beach, S.C.

Change the tubes first, then recheck. A 3A3 with a short or a 6BK4 with grid emission, etc. would do this. Your 3A3 tube is carrying too much current; red-hot plate always means an overload somewhere! Since the 6BK4 is connected across the high voltage at the 3A3 "output", as in Fig. 1, any defect here could be causing this.

Check the bias on the 6BK4. This should be 390 volts on the cathode and 376 on the grid. (Incidentally, the plate of this tube is the cap, and has 25,000 volts on it!) This gives us -14 volts

bias. Normal current in the 6BK4 cathode is about 850 microamperes at minimum brightness.

Cross-check: lift the cap off the 6BK4 and see if the 3A3's plate cools off. If it does, the 6BK4 must be the cause of the overload. Check all resistors and capacitors in the regulator circuit, and don't overlook that .0033- μ f capacitor between grid and cathode.

Horizontal trouble, Trav-Ler 1180-62

I'm having a difficult time with a Trav-Ler 1180-62. Horizontal sync is

out of phase, with a blanking bar in the center of the screen. The horizontal hold control has very little effect. Checked everything I can think of; please send help!—W. G., Baltimore, Md.

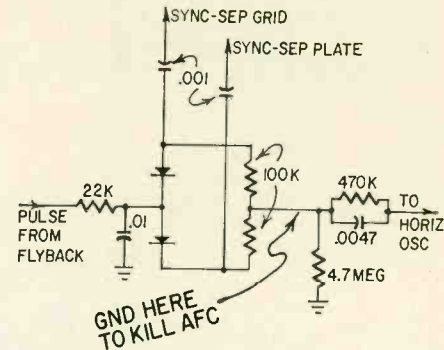

Trav-Ler's horizontal afc circuit.

This problem is in the horizontal afc. First short out the afc, and see if the oscillator can work; that is, make a single picture. If so, then go through the afc network one piece at a time. Most likely suspects here are the afc diodes.

Incidentally, this chassis uses series diodes (diagram). Be sure that they aren't reversed, and replace them, to be sure that they're OK. Check the two .001- μ f sync coupling capacitors for leakage.

No vertical lock, Zenith 16D21

I've got a Zenith with no vertical lock at all. The vertical hold control will roll the picture up and down, but can't stop it. Tubes substituted. Where is it?—H. B., Aruba, Netherlands Antilles

Let's analyze what you've got. The vertical oscillator is capable of running on frequency; you can make the picture move up or down. But it won't stop. So, no sync is getting to the oscillator input.

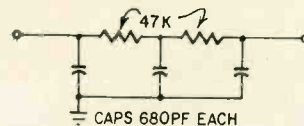

This vertical integrator replaces P-C unit for vertical sync-tests.

In this set, sync is fed to the plate of the 6EA7 (6EM7 in some models); we need about 5-8 volts of sync at this point, positive-going. Pull the 6EA7 and check this with a scope and low-capacitance probe.

It may be the vertical integrator: this set uses the small one-piece integrator that looks like a ceramic capacitor. This one is the "A-1" type. If you want to, you can make up a substitute (see diagram) and hook it in temporarily. The diagram shows the equivalent circuit of the A-1 integrator **END**

MERCURY INTRODUCES THE AMAZING NEW

Model 1101 TUBE TESTER

EMPLOYS EXCLUSIVE
2-POINT TEST PRINCIPLE

This brilliant engineering feature is

- ✓ your greatest safeguard against obsolescence
- ✓ assures a 100% short test (shorts are one of the most common causes for tube failure)...they cannot get by the Model 1101
- ✓ assures that all sections of multi-section tubes will be fully tested

No other tube tester in the Model 1101 price range can make these claims.



will test the NEW DECALS

will test the NEW 7-PIN NUVIATORS

will test the NEW MAGNOVALS

will test all popular PICTURE TUBES

TESTS ALL RECEIVING and PICTURE TUBES for:

- ✓ Dynamic cathode emission
- ✓ Shorts and leakage
- ✓ Grid leakage and gas

A PORTABLE MASTERPIECE

Modern, scuff-proof gray 8 $\frac{3}{8}$ " x 11 $\frac{3}{8}$ " x 3 $\frac{1}{4}$ " case. Weighs only 4 lbs.

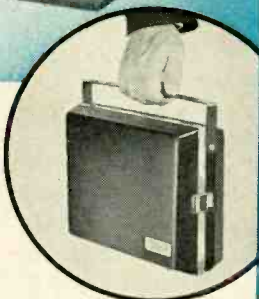

• Also tests Novars, Nuvistors, Compactrons, 10-pin types, battery type tubes, auto radio hybrid tubes, foreign and hi-fi tubes and most industrial tube types • **EXCLUSIVE**... Meter bridge circuit provides accuracy found only in tube testers costing hundreds of dollars • Shorts are detected in tubes even where internal pins are tied or heater is tapped • Provides more tube sockets—including Decal, Magnoval and 7-pin Nuvistor sockets • Sockets are of long-lasting phosphor bronze construction • **EXCLUSIVE**... pin-straighteners for all tube types mounted on panel • Two tone etched aluminum panel always retains its handsome appearance • Shorts and grid leak indicator • Neon jewel power indicator • CRT cable sheathed in matching gray • 3 $\frac{1}{2}$ " D'Arsonval type meter is extremely sensitive yet rugged...protected against accidental burn-out • Includes the most complete tube chart in the field

\$49⁹⁵ Net

The new Model 1101 reflects Mercury's long years of experience in producing tube testers. Nothing has been spared, engineering-wise or production-wise in making the Model 1101 the technician's best tube tester buy. It actually sells for considerably less than the nearest competitive tester, yet it tests more tubes than many tube testers costing hundreds of dollars. Mercury has housed the Model 1101 in an extraordinary lightweight, sturdy airplane luggage design case. You'll be proud to carry the smart looking Model 1101 with you on calls...and you'll appreciate the time it saves you as you test and sell more tubes.

See your parts distributor... write for complete Mercury catalog

Mercury ELECTRONICS CORPORATION
manufacturers of quality electronic products

315 Roslyn Road, Mineola, New York 11501

Circle 21 on reader's service card

free with your purchase of a **PHOTOFACT**® Library—
the supreme gift for your family...
the famous 14-volume NEW STANDARD ENCYCLOPEDIA!

**AN INVALUABLE
 TREASURY OF
 KNOWLEDGE FOR
 ALL THE FAMILY**

sells at retail for
\$149.50

now yours

FREE with the purchase
 of a *Photofact*
 Library consisting of
225 Sets or more—

Offer for limited time only—ACT NOW!

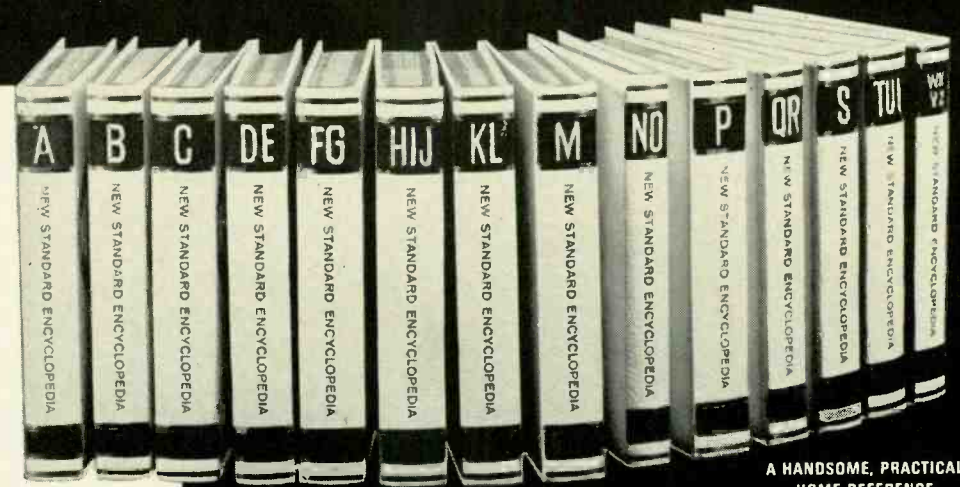

**A HANDSOME, PRACTICAL
 HOME REFERENCE
 LIBRARY**

**Get this wonderful bonus for your family—give
 your earning power a big boost with PHOTOFACT
 —the world's finest TV-radio service data**

Now, more than ever, it pays to own a PHOTOFACT Library—the time-saving, troubleshooting partner guaranteed to help you earn more daily. Now, you can start or complete your PHOTOFACT Library the special Easy-Buy way, and get absolutely FREE with your purchase, the famous 14-volume NEW STANDARD ENCYCLOPEDIA. It's a great reference library for all the family—complete, authoritative, indispensable. Retail for \$149.50—yours absolutely FREE with the purchase of a PHOTOFACT Library consisting of 225 Sets or more!

**THERE ARE 4 CONVENIENT WAYS
 TO SELECT YOUR PHOTOFACT LIBRARY**

1. Complete your present PHOTOFACT Library.
2. Order a PHOTOFACT "Starter" Library—225 Sets (Sets 451-675—coverage from 1959 to 1964—only \$14.29 per month).
3. Order by brand name and year—see the handy selection chart at your distributor.
4. Order a complete PHOTOFACT Library—and the famous 14-Volume New Standard Encyclopedia is yours FREE!

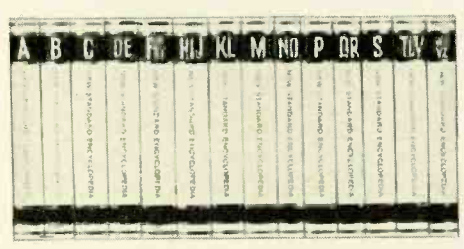

**ORDER YOUR PHOTOFACT LIBRARY NOW—
 AND GET YOUR FREE STANDARD ENCYCLOPEDIA**

See your Distributor for the full details of the PHOTOFACT-Encyclopedia Deal, or send coupon at right! Also ask about a Standing Order Subscription to current PHOTOFACT and Specialized Service Series (FREE File Cabinets available with Subscriptions). ACT NOW!

SEE YOUR DISTRIBUTOR OR SEND COUPON TODAY

OWN A PHOTOFACT LIBRARY THE EASY-BUY WAY:

- Only \$10 down • 30 months to pay
- No interest or carrying charges • Prepaid transportation
- Add-on privilege of a year's advance subscription to current Photofact data, on the same Easy-Buy contract
- Save 30¢ per Set—special \$1.95 price applies on Easy-Buy (instead of regular \$2.25 price)

THERE'S NEVER BEEN A DEAL TO EQUAL THIS!

**GET THE
 DETAILS
 NOW**

HOWARD W. SAMS & CO., INC.

Howard W. Sams & Co., Inc., Dept. REF-10
 4300 W. 62nd St., Indianapolis, Ind. 46206

Send full information on the PHOTOFACT Library-Encyclopedia Deal, and details of the Easy-Buy Plan

My Distributor is: _____

Shop Name _____

Attn. _____

Address _____

City _____ State _____ Zip _____

**“He’s a good worker.
I’d promote him
right now
if he had
more
education
in electronics.”**



Could they be talking about you?

You'll miss a lot of opportunities if you try to get along in the electronics industry without an advanced education. Many doors will be closed to you, and no amount of hard work will open them.

But you can build a rewarding career if you supplement your experience with specialized knowledge of one of the key areas of electronics. As a specialist, you will enjoy security, excellent pay, and the kind of future you want for yourself and your family.

Going back to school isn't easy for a man with a full-time job and family obligations. But CREI Home Study Programs make it possible for you to get the additional education you need without attending classes. You study at home, at your own pace, on your own schedule. You study with the assurance that what you learn can be applied to the job immediately.

CREI Programs cover all important areas of electronics including communications, servo-mechanisms, even spacecraft tracking and control. You're sure to find a program that fits your career objectives.

You're eligible for a CREI Program if you work in electronics and have a high school education. Our FREE book gives complete information. For your copy, airmail postpaid card or write: CREI, Dept. 1410C, 3224 Sixteenth Street, N.W., Washington, D.C. 20010.



Founded 1927
CREI

Accredited Member
of The National Home Study Council

Circle 23 on reader's service card

Be super-critical.

Whether you're looking for the fun and economy of building quality kits or you want ready-to-use factory-wired equipment — before you buy, examine carefully. Compare

EICO with anybody else — feature for feature, chassis for chassis, part for part. The more critical you are, the more you'll see for yourself that your best buy is EICO.



Over 3,000,000 EICO instruments now in use! Preferred by engineers, scientists, technicians and students. EICO equipment is available nation-wide through 2500 EICO dealers.



New Model 435 — DC Wideband Scope. Top-quality DC 4.5mc scope with 3" flat-face CRT. Zener calibrator. Outperforms 5" scopes three times its size, facilitates on-location color TV and other servicing. \$99.95 kit, \$149.95 wired.



New Model 342 — FM Multiplex Signal Generator. Design lab quality. Both composite audio and FM RF outputs. Inputs for stereo audio source for store demonstrations, critical A/B listening tests. \$149.95 wired.



New Model 965 — FaradOhm Bridge/Analyzer. 9-range, low-voltage capacitance-resistance bridge safely measures even 1-volt electrolytics. Metered bridge balance, leakage test voltage (6 DC VTVM ranges 1.5-500V), leakage current (11 DC VTAM ranges 0.15ua-15ma). DC VTVM & VTAM externally usable. \$129.95 wired.



New Model 1030 — Regulated Power Supply. Speeds troubleshooting, design work, production line testing, electronics teaching. Variable bias and plate sources regulated to 1/3 of 1%: 0-150V @ 2ma; 0-400V @ up to 150ma. Ripple less than 3mv rms. Unregulated fil. volts of 6.3V & 12.6V, @ 3A. Switchable, monitoring milliammeter and voltmeter. \$59.95 kit, \$99.95 wired.



New Model 378 Audio Generator. Near-distortionless sine wave generator (< 0.1% 20-20,000c) providing fast, convenient, switch-selection of frequencies from 1c to 1,000c (1c steps 10c-100c, 10c steps 100c-1kc, 100c steps 1kc-10kc, 1kc steps 10kc-100kc). 8-pos. 10db/step output attenuator & fine attenuator. Output meter (4 1/2" 200ua) with 8 voltage ranges & db scale. \$44.95 kit, \$64.95 wired.



New Model 440 Scope. Lowest-priced quality oscilloscope available. Excellent for electronics teaching and home workshop. Flat 2c-500kc. 3" flat-face new CRT. Compact, light, rugged. \$49.95 kit, \$69.95 wired.



New Model 779 — Sentinel 23 CB Transceiver. 23-channel frequency synthesizer provides crystal-controlled transmit and receive on all 23 channels. No additional crystals to buy ever! Features include dual conversion, illuminated S/Rf meter, adjustable squelch and noise limiter, TVI filter, 117VAC and 12VDC transistorized dual power supply. Also serves as 3.5 watt P.A. system. \$169.95 wired.



New Model 712 — Sentinel 12 Dual Conversion 5-watt CB Transceiver. Permits 12-channel crystal-controlled transmit and receive, plus 23-channel tunable receive. Incorporates adjustable squelch & noise limiter, & switches for 3.5 watt P.A. use, spotting, & Part 15 operation. Transistorized 12VDC & 117VAC dual power supply. \$99.95 wired only.



New Model 753 — The one and only SSB/AM/CW Tri-Band Transceiver Kit. 200 watts PEP on 80, 40 and 20 meters. Receiver offset tuning, built-in VOX, high level dynamic ALC. Unequaled performance, features and appearance. Sensationally priced at \$179.95 kit, \$299.95 wired.



New Model 3566 — All Solid-State Automatic FM MPX Stereo Tuner/Amplifier. No tubes, not even nuvistors. Delivers 112 watts IHF total to 4 ohms, 75 watts to 8 ohms. Completely pre-wired and pre-aligned RF, IF and MPX circuitry, plus plug-in transistor sockets. \$219.95 kit (optional walnut cabinet \$14.95), \$325.00 wired including walnut cabinet. UL approved.



Model ST70 70-Watt Integrated Stereo Amplifier. Best buy of highest ranked stereo amplifiers according to independent testing. \$99.95 kit, \$149.95 wired. ST40 40-Watt Integrated Stereo Amplifier, \$79.95 kit, \$129.95 wired. ST97 Matching FM MPX Stereo Tuner, \$89.95 kit, \$139.95 wired.

EICO Electronic Instrument Co., Inc.
131-01 39th Ave., Flushing, N. Y. 11352

Send for **FREE** catalog describing the full EICO line of 200 best buys and name of nearest dealer. I'm interested in:

- test equipment
- hi-fi
- ham radio
- CB

Name _____

Address _____

City _____

State _____ Zip _____

RE-10

1945-1965: TWENTY YEARS OF LEADERSHIP IN CREATIVE ELECTRONICS

Circle 24 on reader's service card

TELEVISION IN SPACE

. . . *Television in space is not to be confused with television on earth; in space everything changes completely . . .*

TELEVISION in space is entirely different from television on earth. Ultraviolet rays, infrared rays, solar flares—to mention only a few things—can have profound effects; little will remain the same in space. It is necessary that we take every sort of precaution, in view of such changes in environment.

A vehicle orbiting in space, as, for instance, the Tiros weather television station, operates under entirely different conditions than those on earth. First, it is in an almost total vacuum. In addition, it is exposed to all the hazards of radiation, meteoroids, extreme cold and extreme heat. Our engineers have met and conquered some of the problems imposed by these hazards; much can still be done on others—and there may be problems we are not yet aware of.

While we no longer expect a vehicle traveling through space to be put out of action by meteor collisions in a few days, probably the sandblasting effect of micrometeoroids has a bad effect on surfaces. It could be particularly harmful to the large surfaces of the solar-cell banks on many of our satellites and other space craft. And it is possible that we have gone too far in minimizing the importance of meteor collision. Explorer II went off the air during a meteor shower, and it is significant that its instruments were registering a large number of meteoroid hits just before it stopped operating.

We have been thinking of vacuum as a friend which, sealed in little glass tubes, has for many years made electronics possible. When it surrounds whole electronic circuits, its action may be anything but friendly. For example, we know that things boil at a lower temperature as pressure goes down. Many operations that call for evaporation are carried on at greatly reduced pressure. When the pressure goes down to that of the vacuum of space, the surfaces of metals, plastics, etc. evaporate or *sublime*. This leads to some interesting effects. If the outside surfaces of two pieces of metal are thoroughly sublimated, leaving the metals absolutely clean, *the two are likely to form a cold weld* when they touch. We remember a number of cases reported in which a motor, television camera or other piece of equipment could not be turned on or off. This cold-weld problem is in some cases already being solved by enclosing the switch, relay or whatever in a pressurized can. Under some circumstances, whole pieces of electronic equipment could be hermetically sealed in an inert atmosphere, but that would be impractical for large units.

On the moon, the effect of all these phenomena will be even rougher. Television will operate in a nearly perfect vacuum, as in space, but something else will have been added: the behavior of lunar dust in a vacuum. Some scientists believe that the lack of air may cause the dust particles to stick firmly together in the way that Johansson

blocks do. If lunar dust is stirred up, it may coat all nearby objects with a sticky opaque film. This could be disastrous to solar cells and television cameras.

The long hot lunar day and the cold lunar night will add problems. It will actually be more difficult to control the temperature of an instrument on the moon than in space. Not only will it have to reradiate the solar heat of the rays falling directly on it, but it will be subjected to reflected radiation from nearby hot lunar surfaces.

In comparing conditions on earth with those elsewhere in our local universe, the effects on other planets are in some cases even greater—or at least more troublesome—than those in space. For instance, if we were to take a television camera to Mercury (which is only 36 million miles from the sun as compared to the earth's 93 million miles), we would have to contend with a temperature nine times hotter than on earth. Designers would have to allow for that. While Mercury would give us an extra platform for observation purposes, the equipment must be provided with safeguards that normally would not be used.

Because of Mercury's proximity to the sun, solar flares will be a much more serious problem than on the moon. A television station on Mercury will have to allow for this as well. The same will be true of future stations that operate as television observatories in space and which would be continuously under bombardment from nearby solar flares, against which we can give them very little protection.

Only on Mars would we find conditions not much worse than on our own planet. It is entirely possible that a good ruggedized piece of military equipment intended for use on earth both at the poles and in the tropics would work well on Mars without modification.

The story is different as we go on out to Saturn and Jupiter. Not only do we have the intense cold and vacuum that we meet in space near the earth or on the surface of the moon, but solar radiation is greatly reduced. This would reduce direct radiation damage, but would make our solar cells less and less useful. This means that we might have to use battery power instead of the solar cells on which we depend so much in our **present** space vehicles. Battery power for television transmitters would be impractical—at least with any batteries we know of today—for lengthy periods. And, unfortunately, lengthy periods would elapse even before our television camera reached the orbits of Saturn or Jupiter. We might even have to consider shelf life of batteries, or depend on entirely new sources of power. Nuclear power may be the only answer here.

There may be other problems we do not even dream of yet, and which may surprise us greatly when we learn about them.

—H.G.

BUILD THIS NEW HIGH-POWER COLORGAN

Had your fill of TV? Then build this modulated-light display and enjoy flowing color with your music

By DONALD LANCASTER

HERE'S A FRESH APPROACH TO A LOW-cost, high-power light-with-music display. The total semiconductor cost of this new circuit is under \$16. Overall cost comes to less than 2¢ per watt of display power. Sensitivity of this 1.2-kilowatt unit is good to well below normal listening levels, and even whisper-level audio will excite the control. Unlike some smaller, lower-power designs, there is no audio threshold or dead space that must be overcome with high drive levels.

Because of a novel filter circuit, only low-cost ceramic disc capacitors are required for audio channel separation. Both the filter characteristics and the time constants (lamp attack and decay time) are easily adjusted to suit individual tastes simply by altering capacitor values.

You'll have full control of background level, to compensate for ambient lighting and the strength of the dyes or filters used with the display bulbs. Because of this full background control range, you can also use the Colorgan, with no audio input, as a conventional three-channel dimmer for advertising



Author's Colorgan is housed in walnut cabinet. Light display is reflected from crumpled aluminum foil.

displays or as a light balance or shadow control with small photofloods in photographic work. If you used the Colorgan to drive three primary-colored spotlights aimed at a single display, the display could be made any color or brightness simply by adding various amounts of the three light sources.

Colorgan vs color organ

Briefly, a Colorgan is an electronic device that relates music to color so that

musical pitch becomes color (hue), and volume becomes intensity. This allows the viewer to watch as well as listen to music, adding a new dimension to musical enjoyment.

Although the concept of color music can be traced to 1725 and a rather unusual musical instrument, the *Clavier Oculaire*, or "viewing harpsichord," the serious treatment of this art form did not develop until the very early 1900's. At that time the Russian composer Alexander Scriabin created a device he called a *Clavier à Lumière*, "light keyboard," or color organ. This was a keyboard instrument that would cause various colored lights to project themselves on a series of gauze veils suspended above a stage. When used in conjunction with a symphony orchestra, "rainbow symphonies" resulted. Quite a bit of interest was aroused in this art form, as a search of the 1910-20 literature will reveal.

A 1935 article in a popular magazine saw the first electronic audio-to-light converter. This device was powered by audio from a radio receiver and used vacuum tubes to separate the audio into three frequency channels—high, medium and low—and then modulate a group of colored pilot lights in a small display. For want of a better name, the author called his device a "color organ."

This misnomer has stuck with these

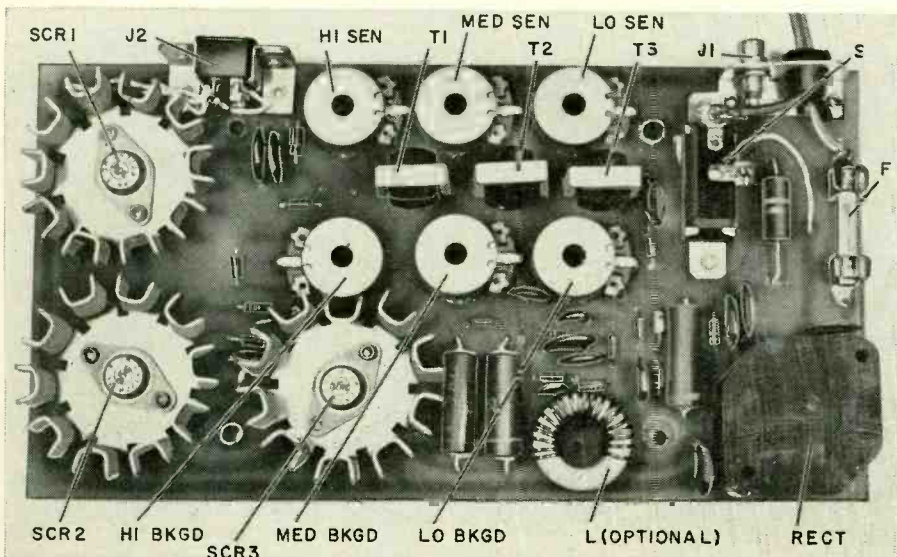

Bottom view of control circuit board.

electronic devices through three decades and a considerable number of "color-organ" designs. To overcome this misnomer, the term *Colorgan* was recently introduced to describe any electronic device that converts music into proportional light variations.

Fig. 1 shows a block diagram of a typical Colorgan. Input audio, from the speaker system of a hi-fi amplifier, is split three ways into high, medium and low frequencies. The audio is then used to control or modulate three primary-colored lamps or lamp banks in a suitable display. The various colors combine to produce an entire rainbow spectrum in tune to the audio input.

Controlling large amounts of 117-volt ac power for the display lamps (usually 25-watt colored bulbs, Christmas-tree light strings or large outdoor spotlights) is easy with silicon controlled rectifiers. Low-cost (\$1.60) SCR's can handle 400 watts easily. This three-channel design uses three such SCR's for a total display capability of 1.2 kw.

How it works

Fig. 2 shows the basic control scheme used, and some of the waveforms. Since the SCR's are unilateral, a full-wave bridge rectifier is required to invert the alternate half cycles for the required unidirectional current. One 10-ampere

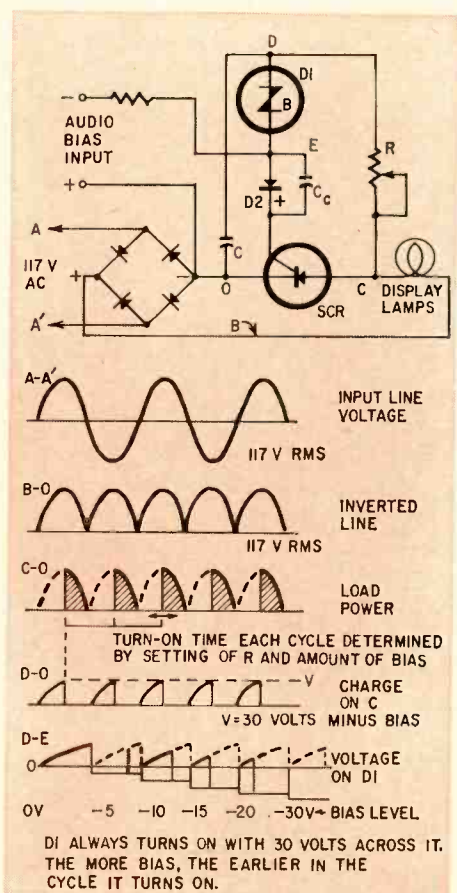

Fig. 2—Basics of one control circuit. Audio back-biases only a diode; hence, input impedance and sensitivity are high.

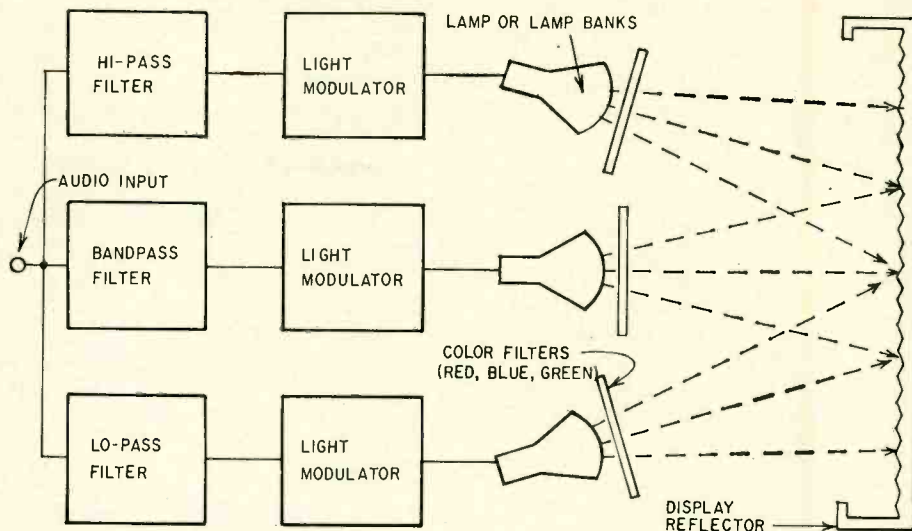

Fig. 1—Scheme of Colorgan is simple. Audio spectrum is divided and used to control wide reflected-light display.

molded bridge assembly (\$4.85) serves all three channels.

The SCR is nothing but a switch in series with the full-wave-rectified ac and the display bulbs. A pulse at the SCR gate turns the device on. It stays on until the first zero-volt point of the ac waveform, then turns off. This happens every half-cycle.

If the SCR is always pulsed very early in each half-cycle, almost all the available power reaches the load, and the lamps light to practically full brilliance. If the SCR's are pulsed on in the middle of each half-cycle, only about half the available power reaches the load, and the lights run at half brilliance. If the SCR's are pulsed on very late each half-cycle, very little of the available power gets to the load, and the lamps light dimly. Thus, by controlling the time in each half-cycle that the SCR turns on, lamp brilliance can be controlled smoothly from full off to full on is possible. Note that this is a full-wave circuit, so the maximum brilliance is the same as if each lamp were simply plugged into the line.

The necessary gate turn-on pulses are produced by a 30-volt avalanche breakdown diode D1. The setting of background potentiometer R determines the rate at which timing capacitor C will charge. When C reaches 30 volts, D1 abruptly conducts and turns on the SCR. The SCR turn-on eliminates the

source of charging current for R, and the charge on the capacitor rapidly drops to zero. The SCR then turns off at the first line zero, and the operation repeats every half-cycle. Since there is zero capacitor charge at the beginning of each half-cycle, the R-C charging is locked (synchronized) to the ac line.

This circuit establishes the background level for the display lamps. If a negative bias of 0 to -30 volts is introduced at the lower end of D1, this 30-volt avalanche diode will always break down progressively earlier in each half-cycle in direct proportion to the bias voltage present. D2, an ordinary diode, and commutating capacitor C, prevent the SCR gate from loading the bias source, but still allow the turn-on pulse to control the SCR. Input audio is stepped up, filtered, rectified, integrated and used as this bias source.

The important thing in this biasing arrangement is that the turn-on energy for the SCR is provided by the 117-volt ac line through R and C, and not from the bias source. This means that the bias voltage works into a very high impedance (actually an open circuit most of the time), and that very little bias power is needed, far less than is required for the SCR turn-on pulses. This is how the Colorgan achieves its high sensitivity without input amplifiers.

Background control R is set to the minimum desired display brightness.

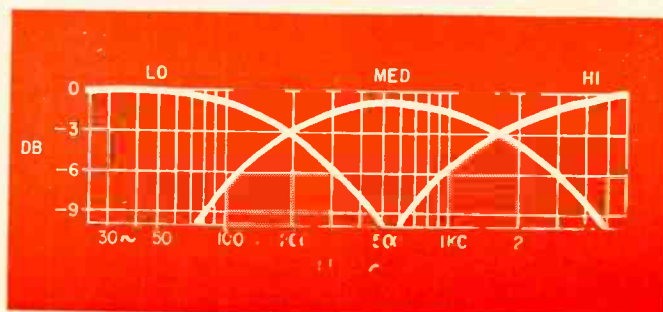

Fig. 3—Response of the three Colorgan channels

The audio bias then increases the brightness in proportion to the music amplitude.

The very high impedance of the bias circuits allows R-C filtering, since R-C filters will function properly only when unloaded. Further, the high impedance means large values of R and small values of C may be used. These may be in the range of ordinary small mica or ceramic disc capacitors. The R-C filter characteristics are shown in Fig. 3; they are as good as the bulkier L-C designs in an earlier version.

Fig. 4 shows the actual circuit. The high-current portions of the circuit are

shown as heavy lines in the schematic. The 117 volts ac goes directly to the full-wave bridge-rectifier assembly RECT after passing through the 10-ampere fuse and the rocker type slide switch. RECT is soldered directly to the printed board; no heat sink is necessary. C1, C2 and L form a noise filter for the line. L consists of 22 turns of heavy wire hand-wound on a powdered-iron core (see parts list).

The SCR's must be mounted on heat sinks. Flower-shaped heat sinks are riveted directly to the printed circuit. Silicone thermal grease must be used between the SCR and the heat sink. The

SCR used is the RCA 2N3228, a low-cost distributor item rated at 5 amperes, 200 volts. Connection to the display is made through a high-current four-prong plug and socket, and a four-wire cable.

The SCR turn-on and background circuitry includes R10, R11 and R12, the background level potentiometers. These pots, along with the input sensitivity pots, are the low-cost Centralab type TT. They solder direct to the circuit board. Diodes D4, D5 and D6 are bypass diodes needed for stable operation at very low brightness levels. Capacitors C3, C4 and C5 are the timing capacitors. C6, C7 and C8 are the SCR turn-on (commutating) capacitors. D10, D11 and D12 are the 30-volt trigger diodes, and D7, D8 and D9 are the bias-blocking diodes. Negative dc bias derived from the audio input is applied to each firing circuit via R2, R3 or R4.

The audio input is stepped up by transformers T1, T2 and T3 to the level required for the bias circuits. These transformers also isolate the circuit common from the amplifier ground. These are relatively inexpensive transformers, also available as surplus microphone or transistor transformers.

The high-voltage audio is then filtered. The low-pass filter consists of C15 and the transformer impedance. The larger C15, the lower will be the rolloff frequency. The high-pass filter consists of C12 and R5. Increasing C12 lowers the rolloff frequency. The band-pass filter is actually an overlapping high-pass (C13 and R6) and low-pass (C14 and T2 internal impedance) filter. Since the impedance level keeps increasing through the filter circuitry, the filters do not load one another, and the ideal 6-db-per-octave filter slopes are actually achieved in this circuit.

The filter response is easily changed simply by altering C12 through C15. Experiment for best results. Changing T1, T2 and T3 from those recommended in the parts list can drastically affect the values required for the capacitors. Removing C15 from the low channel makes this channel a broadband (all-frequency) one, useful for special effects and initial setup.

The filter outputs are rectified by D1, D2 and D3 to obtain the dc bias required to proportionately control the SCR's. Capacitors C9, C10 and C11 determine the time constant (attack and decay time) of each channel. The values used give a time constant of about 0.2 second. This is easily altered to suit your taste by increasing or decreasing C9, C10 and C11.

Characteristics of trigger diodes vary fairly widely especially from manufacturer to manufacturer. Because of this, C3 through C8 may need some trimming. The value of timing capaci-

Fig. 4—Complete schematic of the Colorgan. Heavy lines indicate No. 14 wire.

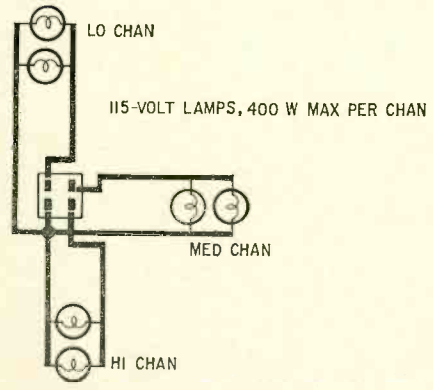
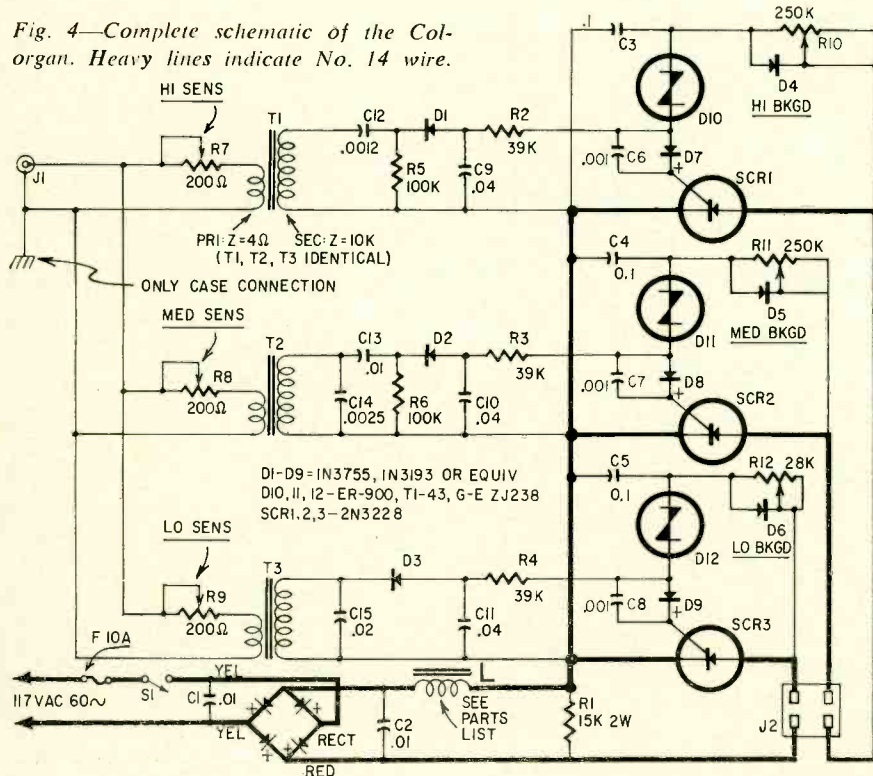

- D10, D11, D12—30-volt avalanche trigger diode (Transitron ER-900, Texas Instruments TI-43, G-E ZJ238 or ST2 or equivalent)
- F—10-ampere fuse
- J1—phono jack
- J2—4-prong socket (Jones S304 AB)
- L—22 turns No. 20 enameled wire on Arnold core No. A 930157-2; 60 μ h approximate inductance (optional interference filter—see text). Core is available for \$1 postpaid from Clare M. Dahl, Dept. Q, 2237 West Glenrosa Ave., Phoenix, Ariz. 85015.
- P—4-prong plug (Jones P304 CCT)
- R1—15,000 ohms, 2 watts
- R2, R3, R4—39,000 ohms, 1/2 watt
- R5, R6—100,000 ohms, 1/2 watt
- R7, R8, R9—pot, 200 ohms (Centralab TT-2)
- R10, R11, R12—pot, 250,000 ohms (Centralab TT-50)
- RECT—10-amp 200-volt full-wave bridge rectifier (Motorola MDA962-3 or equivalent)
- S—10-amp, 250-volt spst rocker switch
- SCR1, 2, 3—2N3228 silicon controlled rectifier (RCA)
- T1, T2, T3—transistor output transformer: 4-ohm primary, 10,000-ohm secondary (Stancor TA-33, Knight 62 G 363, Argonne AR-133 or equivalent)
- Heat sinks for SCR's (3)—Daedalus type 600 blank heat sink; Daedalus Co., 129 1/2 Rosencrans Ave., Manhattan Beach, Calif. (\$0.29 each plus postage.)
- Case, panel, knobs, hardware—see text, drawings and photos

- C1, C2, C13—.01- μ f 600-volt disc ceramic
- C3, C4, C5—.01- μ f 400-volt paper or Mylar
- C6, C7, C8—.001- μ f 600-volt disc ceramic
- C9, C10, C11—.04- μ f 600-volts (two .02 μ f disc ceramic in parallel)
- C12—.0012- μ f disc ceramic
- C14—.0025- μ f disc ceramic
- C15—.02- μ f disc ceramic
- D1 through D9—silicon diode, at least 100 ma, 200 volts (RCA 1N3755, 1N3193 or equivalent)

tors C3, C4 and C5 is correct when the display lamps just extinguish completely at the minimum background control setting. Commutating capacitors C6, C7 and C8 should be the smallest value that allows reliable bias voltage control of the display brightness.

The circuit will operate only on 117-volt, 50- or 60-cycle alternating current, and will control only 117-volt

This control has been used to power everything from small bookshelf displays to lights for the entire side of a house, illuminated as part of a Christmas outdoor lighting display, in tune to Christmas carols.

It is generally better to view reflected light, perhaps off a crumpled aluminum foil surface, than to view the bulbs directly. For maximum color saturation, high-density filters must be used on the light sources with no pinholes to let white light through. The entire rainbow of color may be produced if the colors are rich enough.

One form of display is shown in the photos and is intended as an addition to the typical home hi-fi center. It consists of a 41 x 36 x 10-inch display built of solid 3/4-inch walnut. The entire inside of the case is lined with heavy aluminum foil lightly crumpled to aid diffusion and allow the lights to dance. The ornamental G-clef in the middle is cut out of 1/16-inch copper and is highly polished. The 8-32 studs supporting it are essentially invisible, allowing the clef to apparently float on a sea of dancing color.

I used ordinary 25-watt colored bulbs in the display. The dyes on these bulbs are rather poor, being unsaturated and full of pinholes, but the overall effect is quite acceptable and inexpensive. There are six bulbs per channel, giving 18 bulbs total equally divided between top and bottom. The photo shows how the bottom bulbs are situated. The low-channel bulbs (red) are predominately at the left. The high-channel bulbs (blue) are predominantly at the right, leaving the mid-channel (green) illuminating mainly the center. If all the bulbs of one color are bunched together, the display is just three stripes with no color blending.

For larger displays, a new line of 150-watt bulbs is now available. These have an optical interference filter on the inside of the glass, resulting in a deep, saturated color, with no pinholes and no light leakage. The color-mixing possibilities are dramatic. One source of these bulbs is the General Electric line of 150 PAR/SP Dichro-Color spot lamps. These allow larger and richer displays.

It is the display that gives uniqueness and character to any Colorgan. It should be custom-designed for each application. There are no real ground rules, no limits to the bulbs or materials you use, or to the designs a display can lead to. Just be sure to follow sound electrical wiring practice, and keep your workmanship neat.

Fig. 5—Cross-section of Colorgan control box shows assembly.

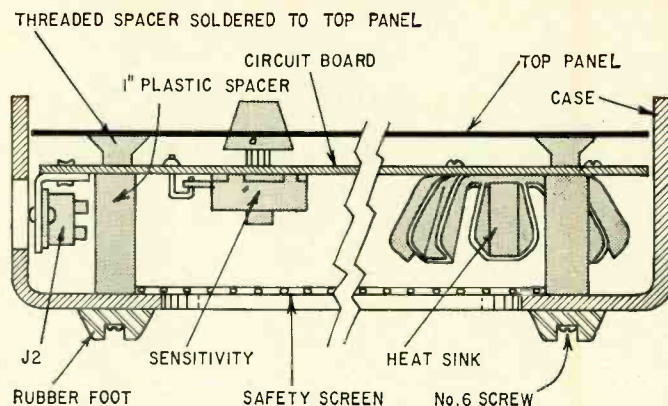

incandescent bulbs (or series combinations of lower-voltage bulbs) or other resistive loads. The *minimum* load for any channel is 10 watts.

No portion of the control circuitry or the display (with the sole exception of a case connection at J1) may be grounded or connected to any other piece of equipment. To do so introduces a severe shock hazard and can immediately destroy the rectifier.

The entire circuit is built on a single 5-inch by 9-inch printed-circuit board. All parts are soldered or "pop"-riveted to this board, including the heat sinks, the input and output connectors and the fuse clips. A small aluminum

bracket supports the input phono jack and the line-cord strain relief. The decorative case consists of a 1 3/4-inch deep-drawn thick aluminum box (Zero Manufacturing Com., Monson, Mass. #Z89-158-28, \$5.10). A large hole is cut in the bottom for ventilation. A piece of hardware cloth is riveted to the inside as a safety screen. Holes in the back are for the audio, display and power connections. The case is finished in heavy gray wrinkle.

The top plate is a piece of thin aluminum with four threaded spacers soldered to its underside. Holes are drilled for the six knobs and the rocker switch. A lacquered matte finish completes the plate. The knobs are translucent plastic in colors corresponding to each control's function. I couldn't find a reasonably priced commercial source, so I cast them out of acrylic resins of the required colors.

Four long 6-32 screws hold the entire Colorgan together (Fig. 5). One-inch plastic spacers support the circuit board at the proper height.

Except for the knobs and fancy case, all parts are readily available and cheap. Although this circuit lends itself very nicely to a printed-board construction, you might prefer to use a wired assembly, perhaps with tie points or terminal boards. A slightly larger package might be needed. No. 6 hardware could be used instead of the rivets.

If you do use a printed board, be sure to use at least 1/8-inch conductors of 2-oz. copper, or 1/4-inch conductors of 1-oz. copper in all high-current circuits.

For stereo operation, the mono output of most stereo amplifiers may be used. Another possibility is to use a "phantom" transformer connection. Two identical Colorgan circuits of three channels each could both drive a common display.

The number of channels can be increased indefinitely, but one 10-ampere rectifier must be used for every 1,200 watts of load, regardless of the number of channels. The maximum power capability of the SCR's used is 600 watts.

END

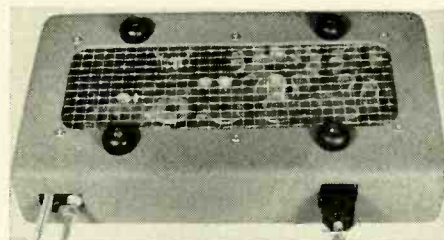

Underside of case.

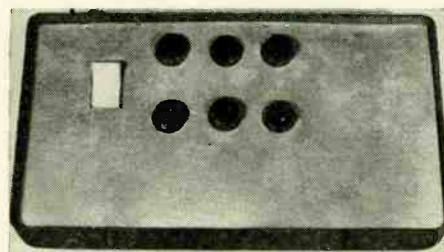

Panel of Colorgan control. Colored knobs eliminate need for markings.



Downward view into front of Colorgan shows how lamps are placed near foil reflector.

Latest Transistor Power Amplifier Designs

A roundup of current trends—who's doing what, and how the circuits work

BY DANIEL MEYER

THE LAST 3 YEARS HAVE SEEN A NEW generation of high-fidelity power amplifiers. Most of the major hi-fi manufacturers have introduced all-transistor equipment. Many earlier entries suffered from inferior high-frequency response and limited power output above 10 kc. This problem has been solved by diffused-base power transistors that work well up to 100 kc and much higher. The older alloy transistors usually cut off around 7 to 10 kc and would tend to overheat and cause distortion if run at full power at higher frequencies.

The latest transistor power amplifiers have wider frequency response, cleaner overload characteristics and better efficiency than the vacuum-tube types they replace. This has been discussed in several articles comparing the two types of amplifiers.^{1,2}

Transformerless—almost

Most transistor amplifiers now available use a "single-ended push-pull" output circuit with no output transformer. Good output transformers are large, heavy and expensive. Even the best introduce phase shift at the higher frequencies and a loss of coupling at the lower end.

Although output transformers have been eliminated, we still find matching or driver transformers in many of these amplifiers. These are generally small and

¹ von Recklinghausen, Linder and Mason: "Transistors for Hi-Fi; Panacea or Pandemonium," Sept., Oct., 1963, *Electronics World*
² Miller, Gradinsky and Westra: "Transistors vs Tubes for Hi-Fi," Nov. 1963, *Electronics World*
 Berwen Dec. 1963, *Electronics World*

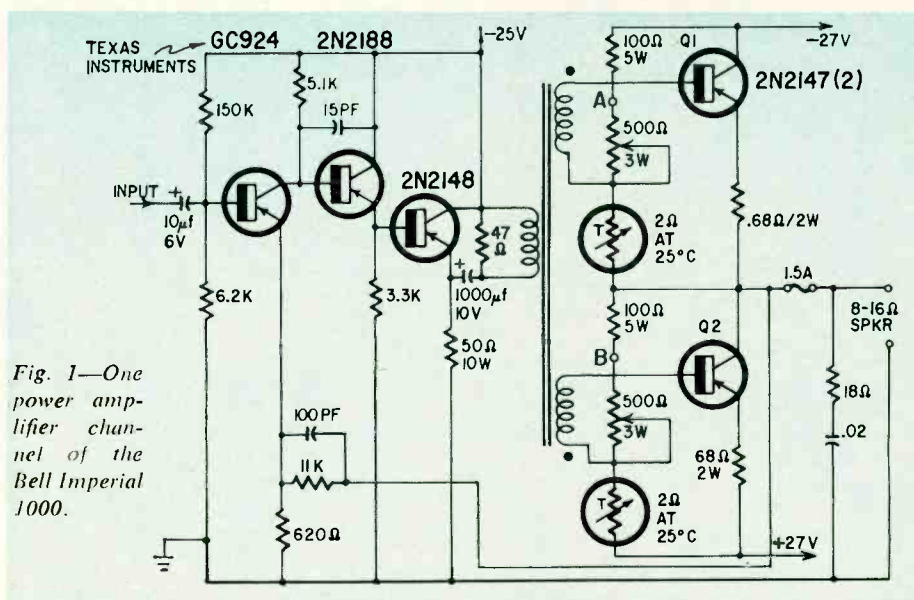

Fig. 1—One power amplifier channel of the Bell Imperial 1000.

present much less of a problem than output transformers do.

Two main types of circuits are being used now.

Symmetrical, transformer-driven

The circuit in Fig. 1 of the Bell Imperial 1000 is among the most popular now. The two output transistors are in series with the two power supply voltages, instead of being in parallel across one supply as is common in vacuum-tube amplifiers. The driving signals to the two transistors are out of phase to produce a push-pull output. The transistors are operated as class-AB com-

mon-emitter amplifiers.

For large negative-half-cycle signals, the circuit is as shown in the simplified drawing of Fig. 2-a. The lower transistor Q2 is cut off and the upper transistor Q1 drives the load. The signal is applied between the base and emitter of this transistor and the output is taken between the collector and emitter, so this is a common-emitter amplifier. On positive half cycles, Q1 is cut off and Q2 drives the load. The interchanged positions of the load and power supply in the two cases has no effect on the circuit's operation—the output is still taken between collector and emitter. Since the

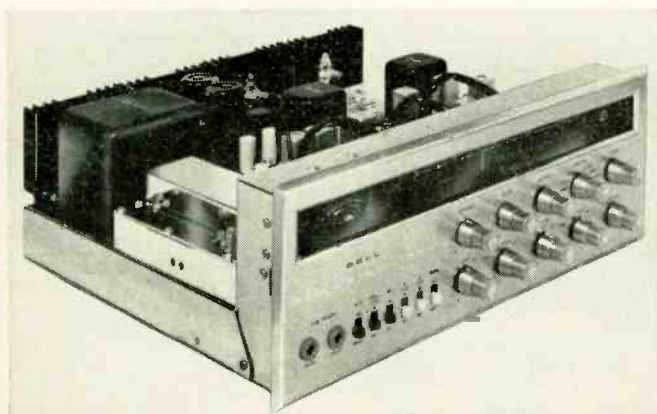

Acoustech III stereo power amplifier (above); Bell Imperial 1000 FM-stereo receiver (left).

The Acoustech circuit, diagrammed in Fig. 4, is an asymmetrical transformerless design. The Bell amplifier (Fig. 1) uses a driver transformer in each channel.



Heath AA-21 integrated stereo amplifier.

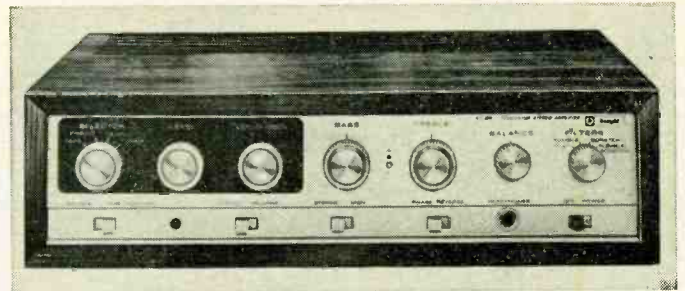

Knight-kit KG-870 stereo amp/preamp.

speaker is connected to a zero-dc-voltage point between the two transistors, no coupling transformer or blocking capacitor is necessary.

A driver transformer is necessary in this type circuit to provide the low-impedance, isolated drive signals needed by the output transistors. This transformer is usually trifilar-wound, to get the necessary close coupling between the driver and output stage and between the output transistors, and to prevent inductive spikes in the transformer when the output transistors turn off.

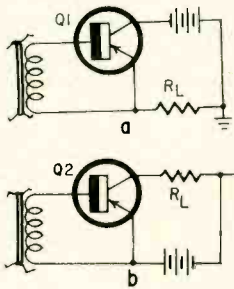

Fig. 2—Simplified circuit of design in Fig. 1. Both (a) and (b) are common-emitter stages.

The driver stage is operated class-A, and shunt-feeds the primary of the driver transformer. This keeps the relatively large standby or quiescent current drawn by this stage from flow-

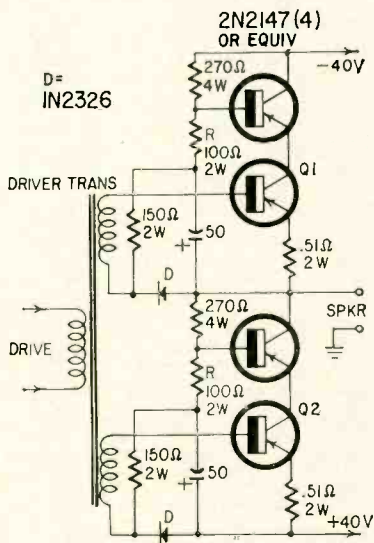

Fig. 3—A variation of Fig. 1 for higher power output, used by Heath, KLH, Knight, Fisher and others. This has been called the "totem pole" circuit.

ing through the transformer and causing core-saturation problems.

The first stage is a voltage amplifier coupled to the driver by an emitter follower. Feedback is taken from the speaker terminals back to the first stage. The feedback loop is dc-coupled. The potentiometers in the bias network of the output stage (Fig. 1) set the output transistors to the correct operating point to prevent crossover distortion.

This amplifier is rated at 40 watts 1HF each channel with less than 0.7% 1M distortion. Power bandwidth (3-db-

age, can exceed the voltage rating of a single transistor. To prevent voltage breakdown, an additional transistor, operated as a common-base amplifier, is used in series with each output transistor. The circuit is shown in Fig. 3.

The upper common-base transistor is biased so that the supply voltage divides between the two transistors. (The 100-ohm resistors R do not materially affect the common-base operation. They only swamp out variations in base resistance. The lower end of each 100-ohm resistor is "clamped" by the 50- μ f ca-

Fig. 4—Circuit of the Acoustech III, with silicon output transistors.

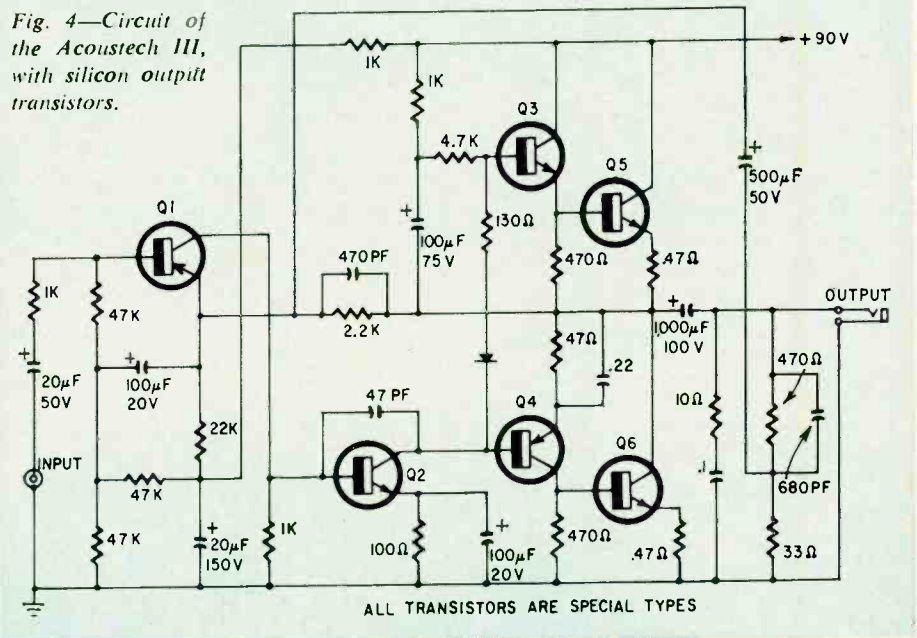

down points) is from 9 cycles to 65 kc at full power.

This circuit is used with some changes in the Heath AA-21, Knight KG-870, KLH Sixteen, Fisher TX-300 and others. These amplifiers use two extra transistors in the output stage to make possible higher output by using higher supply voltages. In a transformerless circuit, the maximum power output is determined by available supply voltage. Since there is no output transformer to step the output voltage up or down, the only way to increase the voltage across the load is to use a higher supply voltage. This additional dc voltage, when added to the peak audio volt-

pacitors.) The lower transistor drives the emitter circuit of the upper transistor. Since a common-base amplifier has less than unity current gain, the upper transistor acts more or less as a variable load resistor for the lower transistor. In addition to increasing the output-stage voltage rating, this extra transistor helps prevent power supply hum from reaching the speaker. This is due to the very high output impedance of a common-base stage. Hum voltage at the collector of the upper stage sees a very high impedance and is blocked from reaching the speaker terminals in any significant amount.

This type amplifier, using RCA

2N2147 or similar transistors, can produce over 50 watts in a 16-ohm load with less than 1% distortion, and a frequency response from 10 cycles to 70 kcs.

No transformers at all

A second major type of circuit is used in the Acoustech I, I-A and III, and Harman-Kardon's A1000T and Citation B. The circuit of one channel of the Acoustech III is shown in Fig. 4. This amplifier uses a single-ended push-pull output stage with a single-polarity supply voltage. The speaker is coupled to the output stage through a large electrolytic capacitor. The output transistors are driven by two driver transistors instead of a driver transformer.

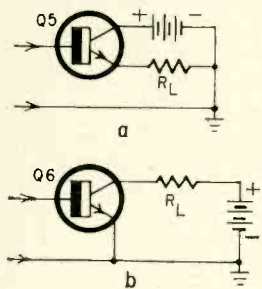

Fig. 5—"Upper" output transistor in Fig. 4 operates common collector; "lower" transistor (b) operates in common emitter.

This circuit is not symmetrical. That is, the two output transistors are not operated in the same way as in the previous circuit. As is shown in the simplified circuit of Figs. 5-a and 5-b, upper transistor Q5 is operated as a common-collector stage, while lower transistor Q6 is operated as a common-emitter stage.

This is not as serious as might be supposed. The current gain of a common-emitter stage is $\alpha/(1-\alpha)$, while the current gain of a common-collector stage is $-1/(1-\alpha)$. The difference is very small with high-gain transistors. The output impedances of the two transistors will also be different, but the large amount of feedback used in this amplifier reduces the output impedance of the output stage to the point where it is impossible to detect any difference in output impedance between positive and negative high cycles.

The output transistors are operated in class B. The upper transistor amplifies the negative half cycles of the signal and the lower transistor the positive half cycles. The driver transistor for the lower output transistor is a p-n-p type. This inverts the phase of the signal applied to the lower output transistor for push-pull operation.

Input transistor Q1 is "bootstrapped" for high input impedance, to prevent loading the preamp too heavily. It also supplies some gain and points for attaching the two major feedback loops. Q2 is a voltage amplifier, direct-coupled to driver transistors Q3 and Q4. The driver bases are coupled through a diode for temperature compensation.

The open-loop gain of this circuit is extremely high—around 3,000. This is reduced to 10 (approximately) by a combination of ac and dc feedback loops which control stability, distortion and output impedance. The manufacturer claims it is possible to mate any output transistor of the correct type with any other of the same type, use the pair with any randomly selected amplifier/driver circuit board, and get distortion within a few hundredths of a percent of the specifications without any adjustments.

Since the output from this type of amplifier is limited by the supply voltage, the output power depends on the value of load impedance connected to the output. This generally causes the output to be lower with loads other than that specified. To overcome this limitation and to allow the amplifier to be used on 70-volt PA systems, Altec uses a matching transformer with its 351B amplifier. With 4-ohm loads, the circuit operates as an output-transformerless amplifier, but higher-impedance loads are connected to taps on an auto-transformer. This provides full rated power output with 4-, 8-, and 16-ohm and 70-volt loads.

The circuit of the Harman Kardon is similar in the output stage, but the earlier stages are substantially different. A split-load phase inverter is capacitively coupled to the driver transistors. The driver and output stages all use n-p-n transistors.

Something different

A rather novel approach to power amplifier design is found in the Lafayette

Berwen: "A Transistorized 200-Watt Stereo Amplifier," Nov. 1962 Audio

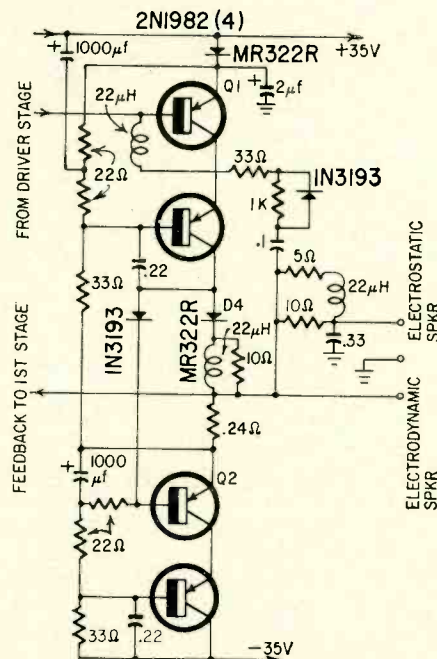

Fig. 6—Output stage of Lafayette LA-280, which uses low-cutoff-frequency, high-power germanium transistors.

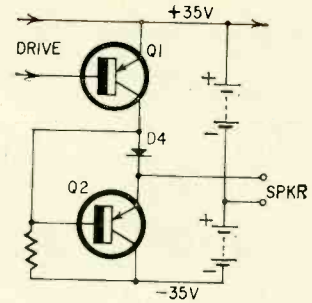

Fig. 7—Simplified circuit of LA-280. Its operation is explained in the text.

ette LA-280 200-watt amplifier.³ (Not a commercial product at this writing.) In this circuit (Fig. 6), the output stage is highly unsymmetrical. The simplified circuit of Fig. 7 shows how it works. Transistor Q1 drives the speaker load through diode D4 on negative half cycles. This is a common-emitter amplifier. On positive half cycles, D4 is reverse-biased and disconnects Q1 from the load. Q1 now drives the base of transistor Q2, a common-collector amplifier. Since the current gain on negative half cycles is only that of Q1, while the current gain on positive half cycles is the product of the current gains of Q1 and Q2, the circuit is highly unsymmetrical.

This lack of symmetry is not as bad as it might appear. Almost 100 db of feedback is taken from the speaker terminals back over five stages, and although the signal inside the feedback loop is highly distorted, the distortion at the output is much less than 1%. A second nonlinear feedback loop around the output stage equalizes the response time on positive and negative half cycles. An inductor in series with D4 eliminates charge storage effects in the diode. The output transistors are large, high-power, low-cutoff-frequency germanium types, necessary to produce the desired high output. The high-frequency response of the whole amplifier is good, because of the large amount of negative feedback and the high level of drive to the output transistors.

The two extra transistors in the output circuit increase its voltage-handling ability, just as was done in the circuit of Fig. 3. They operate as common-base amplifiers as previously described.

Although rather unorthodox, this circuit can produce an output of 100 watts per channel IHF into a 4-ohm load with less than 0.2% IM distortion. The 3-db power response is from 15 cycles to 80 kc.

These circuits represent the majority of the designs now in use. In the short time since their introduction, transistor power amplifiers have made a secure place for themselves. The future is sure to bring even better transistor amplifiers as better transistors are developed.

END

TV Technician's Dictionary

TEXT & ILLUSTRATIONS BY FRANK SALERNO

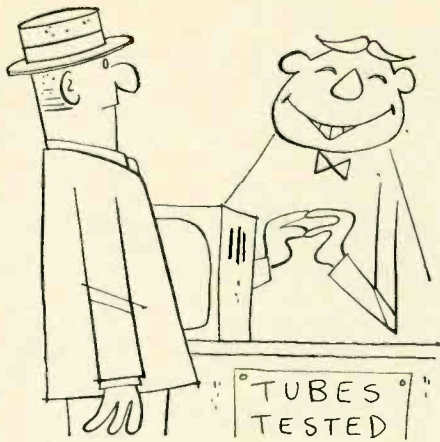

HAPPINESS

Happiness is when a customer walks into the shop with a 17-inch portable and leaves it to be checked out because the pictures are snowy.

Disappointment is when you stick in a couple of new tubes but they don't seem to help.

Surprise is when you open the tuner and find no burned resistors, no broken coils or anything else that's obvious.

Puzzlement is when after hours of troubleshooting you still haven't been able to get rid of the snow even after changing an assortment of parts on general principles.

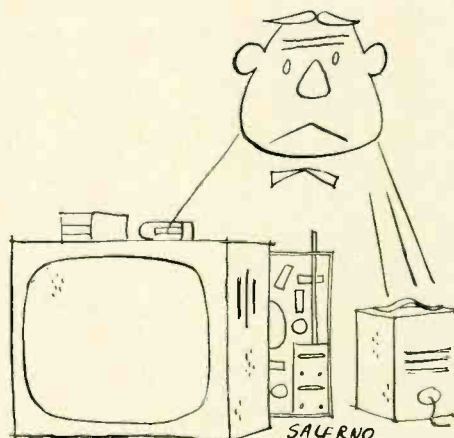

DEJECTION

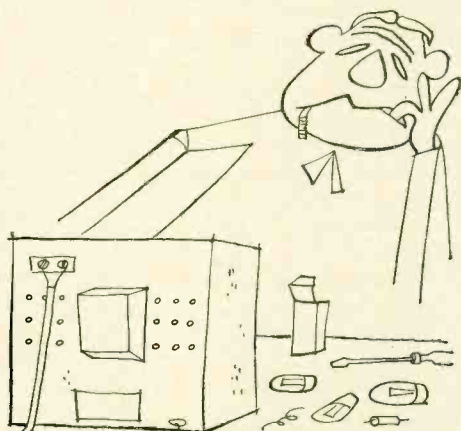

DEPRESSION

Dejection is when you discover that on top of the snow problem the tuner suddenly decides to become erratic on the high channels and cleaning doesn't help.

Hope is when you find out that you can get an exchange tuner at a reasonable cost and the customer agrees to the estimate.

Pleasure is when you first turn the set on after wiring in the new tuner and you see your first solid, snow-free picture.

Depression is when, after closing the set and putting it aside for an air test, you notice a creeping vertical drift after the set gets heated up.

Patience is when you tear the set down again, heat some capacitors with a hot iron and find the one that is causing the vertical to drift.

Annoyance is when, after closing the set again and leaving it for another air test, you notice a gradual stretching at the top of the picture.

Frustration is when you tear the set down once again, heat up some more capacitors with the hot iron and find another one that's causing the picture to stretch.

Exasperation is when you close the set for the third time and leave it to cook and you discover an intermittent video overload that's being caused by a bad i.f. tube.

Despair is when after a 3-hour air test you find that the picture is very quietly and barely noticeably getting darker, and darker, and darker.

Fear is when your preliminary checks prove inconclusive and you then begin to suspect that maybe the picture tube is bad and the whole job may go down the drain.

Relief is when you tear it all down once again and you find that the video coupling capacitor going to the picture-tube cathode is leaking and causing the loss of brightness.

Madness is when you put the chassis back in the cabinet, turn it on, and now find that the horizontal oscillator has gone wild and you are unable to bring in a picture.

Insanity is when you tear it all down once again and change the dual-diode phase detector.

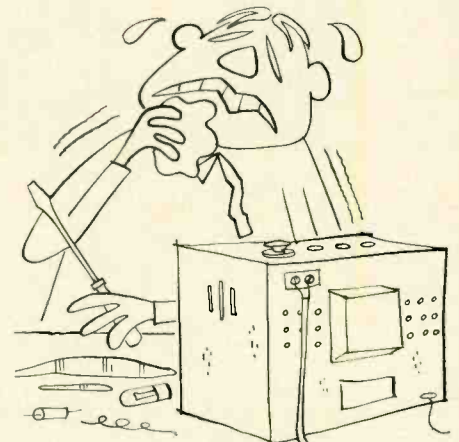

FRUSTRATION



MADNESS

Joy is when you give it one more air test and watch the set behave like a good set should.

Happiness is when the customer comes around to take the set away and tells you that he's moving out of town on the following day and you know you'll never see that one again. END



HAPPINESS

Microwave Motors – Space-Age Power?

New motors run on beamed power up to 1,000 mc. Build one yourself

By HARRY E. STOCKMAN*

In the January 1965 issue, RADIO-ELECTRONICS reported on Raytheon's successful demonstration of a model helicopter sent 50 feet into the air by microwave radiation. This article is the first to present an experimental rf motor (using a somewhat different approach) for home construction.

FOR YEARS WE'VE HAD DC, 60-CYCLE AC and a few 400-cycle ac motors. Now we have extended motor operation up into the rf range. There are motors smaller than pinheads. Brushes seem to be things of the past. We have the brushless transistor motor and the brushless tunnel-diode motor.¹

As frequency of operation goes up,

* Professor of Electrical Engineering, Lowell Technological Institute, Lowell, Mass.

¹H. D. Brailsford, patent No. 2,719,944; and H. E. Stockman, patent application No. 127,018, respectively.

beamed electromagnetic radiation can be used to power motors at considerable distances. Tesla's old dream of wireless power transmission is coming true.

The motor design in Fig. 1 has one outstanding feature: it's brushless. This is important for maintenance-free operation at a distance. To eliminate moving electric contacts, rf motors should use some kind of self-commutation.

The motor of Fig. 1 uses a loop antenna, L1, tilted 45° to the motor shaft. The direction of the magnetic field is shown by the straight arrow, marked ϕ .

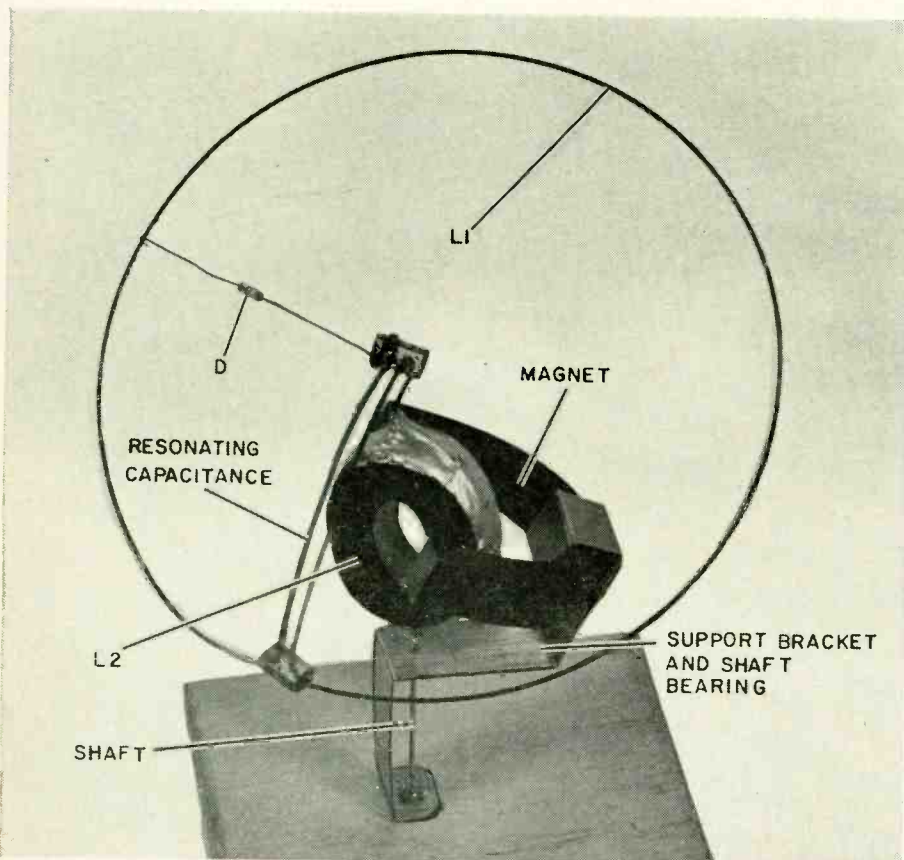

Experimental working model of radiation motor diagrammed in Fig. 1.

As the rotor turns, loop L1, mounted on the rotor shaft, lies along the magnetic field (parallel to the arrow) in one position. When the shaft has turned 180°, the loop lies perpendicular to the direction of the arrow—intercepts maximum field.

Current induced in the loop is rectified by diode D. The current, smoothed by capacitor C, creates a magnetic field around L2 and, reacting with the permanent field around the magnet N-S, causes the whole rotor assembly to turn. The rotor receives a push during half of its rotation, coasting for the other half.

If we arrange several loops—three, for instance—with several multiturn rotor coils (L2) on the same shaft at different angles, we have a self-starting motor.

This kind of motor can be built for frequencies up to 1,000 mc. The photograph shows a small experimental motor, operating a few feet from a 50-mc oscillator. The loop could be provided with a ferrite core for increased efficiency.

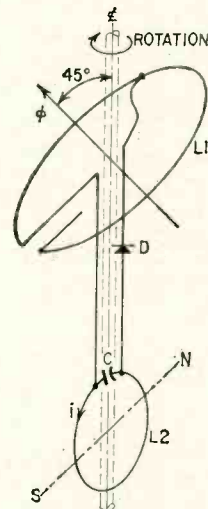

Fig. 1 shows the schematic of a rotating-loop motor. L1 picks up rf, turning with rotor to "chop" energy and keep motor going.

The same principle has been used in another motor where L1 is replaced by a dipole in a reflector (parabolic dish) or horn.

A particularly interesting and valuable application for the motor with a parabolic antenna is providing modulated radar target returns for use as beacons, markers, etc. The motor reflector is kept rotating by a strong radar beam, and may be interrogated at any time by other radars far away. Because of the modulation of the return, provided by the rotation, we can get considerable increase in range and more reliable identification of the target. Though work along these lines has been going on for some 20 years, only very recently have we been able to make self-rotating targets.²

In some designs, the antenna rectifier has been replaced with solar cells.

²See H. E. Stockman, "Communications with Reflected Power," *Proc. IRE*, No. 10, October 1948.

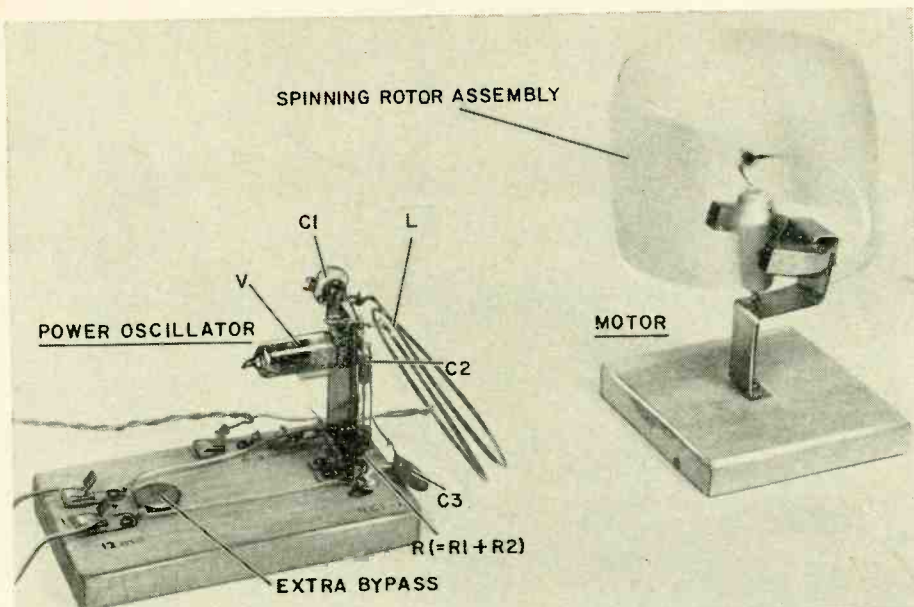

The experimental model spinning along, powered by oscillator shown in Fig. 2. System like this has been running constantly on display at Lowell Technological Institute, Lowell, Mass. It operates at about 70 mc.

I have run light-operated motors from across a room with only an ordinary flashlight beam. This suggests that someday soon we may be able to power motors in space with lasers.

Make one like it?

You can build a working model of the motor shown in the photographs—but only for your own amusement. Patent law prohibits selling motors based on this principle, without special arrangement.

[The motor may be built as a display for a science fair or the like, but credit must be given Dr. Stockman.—*Editor*]

The exact frequency of the system is not important, but the resonant frequency of the motor should match the operating frequency of the oscillator that drives it. The oscillator of Fig. 2 works at about 70 mc. The loop antenna, L1 in Fig. 1 and the photos, can be a ring of phosphor bronze or copper wire about 7 inches in diameter. The resonating capacitance is either a bent-back part of the loop wire, as shown in the photo, or a ceramic capacitor of a few pf inserted in the loop (electrically in series with it).

The wire of loop L1 comes down vertically and passes through drive coil L2, finally being wrapped and soldered around a heavy sewing or darning needle which serves as the shaft. (This is visible below L2 in the photograph.) The magnet support and upper shaft bearing are the same piece—a strip of brass, bent as shown, with a hole to pass the shaft. The bottom of the strip is fastened to the wood base with a Phillips screw, whose cross-slot is the lower bearing.

Diode rectifier D can be any small high-frequency germanium or silicon di-

ode—a radar mixer crystal or a video detector. It must be connected to a point on the loop that gives maximum current; this is the same as tapping down on a coil to feed a low-impedance source, or finding a current point on a resonant antenna. You'll have to experiment. Try several diodes and several tap points, and pick the combination that gives the highest speed.

L2, the rotor coil, is not critical; its dimensions depend somewhat on the horseshoe magnet you use. Try to find an Alnico or similar magnet, as strong as possible. The inner diameter of L2 might be something like $\frac{3}{4}$ inch. The winding cross-section should be roughly square, as shown in the photo. Try about 900 turns of No. 30 enameled wire as a start, giving a $1\frac{1}{2}$ -oz. coil of about 25 ohms

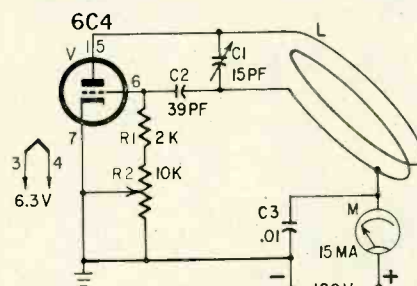

Fig. 2—Circuit of power oscillator. See text and parts list for details.

Motor parts (see text)

D—hf crystal diode (1N60, etc.)
L1—loop of phosphor bronze or copper wire
L2—900 turns No. 30 enameled wire
Magnet, bearing strip, base

Oscillator parts

C1—variable, 15 pf
C2—39 pf ceramic or mica
C3—.01 μ f ceramic
L—see text
M—0-15 or 0-25 ma dc meter
R1—2,000 ohms (or 2,200), $\frac{1}{2}$ watt
R2—pot, 10,000 ohms
V—6C4
Chassis or base, socket, miscellaneous hardware
Power supply (see text)

dc resistance. Squeeze the doughnut-shaped winding oval until its narrow dimension can pass freely between the poles of the magnet. Then fasten it to the phosphor bronze or copper wire of L1 (the vertical part) with radio cement and tape so that its long dimension is parallel with the vertical wire.

Capacitor C is not essential but improves operation. Try a .001- μ f ceramic, across the end wires of L2.

The oscillator

Fig. 2 is the oscillator circuit that supplies motive power for the experimental motor. Values are not at all critical. The combination tank-coil-antenna is two spaced turns of No. 12 copper wire, $3\frac{1}{2}$ -inch diameter. Self-supporting, it should lie in a plane 45° from vertical, like L1 in the motor. Keep leads short, stiff and direct. One end of L may be soldered directly to pin 1 or 5 of the 6C4 socket, saving a connecting lead. Note that L is tapped not at its center but well toward the grid end. Move the tap around and adjust R2 for maximum rf output.

If you have a grid-dip meter or rf signal generator, simply trim inductance and capacitance values in both motor and oscillator until the two work at the same frequency. If not, do it by cut-and-try. Fire up the transmitter and wave your hand past its loop coil; the meter should fluctuate.

Set up the motor about a foot away from the oscillator. If nothing happens, rotate C1 to bring the two units into resonance. If still nothing, check for wiring errors or excessive friction. Put a vvm across the motor's L2 and see if some setting of C1 in the transmitter increases the reading. If not, the motor and oscillator frequencies are too far apart. Make a frequency meter out of a coil and capacitor just like L and C1 in the oscillator circuit, using a crystal diode and low-range milliammeter as an indicator. Mark off the oscillator's tuning range on the variable capacitor of this frequency meter.

Now remove L and C1 from the transmitter circuit, and substitute L1 and the associated tuning capacitance from the motor. Turn on the transmitter, using these motor parts as tank, and see whether its range now lies within the limits you marked off as the high and low ends of the tuning range with the original components. If so, fine; if not, prune one resonant circuit or the other until they are aligned.

END

References

- R. C. Garnier and T. K. Ishii, "Microwave Motor Utilizing a Double Antenna and a Double Coil," Proc. IEEE (Correspondence), Vol. 53, p. 178; Feb., 1965.
Garnier and Ishii, "Microwave Motor," Proc. IEEE (Correspondence), Vol. 52, pp. 1380-1381; Nov. 1964.
H. E. Stockman, "Parametric Motor energized by radio-frequency field," Proc. IEEE (Correspondence), Vol. 51, pp. 1253-1254; Sept. 1963.

Simple resistors-and-battery adapter extends
vom ohms range down to 1/20 ohm or less

VOM Scale Expander Measures Low Resistances

By R. C. ROETGER

TROUBLESHOOTING TRANSISTORIZED equipment frequently requires distinguishing between two very low values of resistance. The difference between $\frac{1}{4}$ and $\frac{1}{2}$ ohm can be important. Comparison of transformer windings often requires similar readings. Absolute accuracy is not essential, but difference must be well defined. The scale on most vom's is not suitable for such measurements.

The plug-in meter accessory shown in the photograph serves the purpose and is far cheaper and less cumbersome than a Wheatstone bridge. The device is basically a bridge except that the un-

known resistance is read on the vom scale instead of being compared with a standard as indicated by a null on a galvanometer.

The circuit is shown in Fig. 1. Resistor R1 balances the bridge; sets the meter to zero with the test leads shorted. Resistor R2 calibrates the meter—sets it to a particular place on the scale for a given value of resistance. Switch S prevents battery drain when the instrument is idle and also prevents pegging the meter when the test leads are open (infinite resistance). Component values are not critical and indicate only what parts were available.

All components are mounted on a right-angle bracket made of two pieces of plastic fastened together with a pair of 6-32 machine screws (Fig. 2). The top plates illustrated are for the Simpson 260 and 269 and the Triplett 630 vom's. Slight changes will accommodate other meters.

Standard banana plugs with the insulators removed were pressed into the holes in the plate and the connections soldered to the shoulder underneath the plate. If the press fit is too loose, a little plastic cement will correct it.

The battery holder and connectors were made of spring brass as shown. (A commercial battery bracket would have simplified matters.)

Trim pots were used for R1 and R2 because they happened to be on hand, but a midget conventional pot may be used for R1. R2 may be a "trimmed" fixed resistor.

Resistor R3 is mounted by inserting its pigtails through small holes in the bracket and putting a bead of solder on each side. Tiepoints for the Trimpots were made the same way.

Any single-pole, normally open, momentary-contact switch may be used for S1. The miniature microswitch pictured is easy to mount.

The jack type binding posts accommodate regular meter test leads. Special leads can be connected without using plugs. Any connectors may be used, provided their resistance is low and remains constant.

Calibration

Plug the Expander into the vom and short the Expander test leads. With the vom on a milliamp scale, close S1 and adjust R1 to zero deflection. For a rough balance. Then change the vom to a microamp scale and reset R1 for zero deflection.

Note: When adjusting for a Simpson 260, make temporary connections from the Expander plugs to the COMMON and "+" jacks on the vom and do

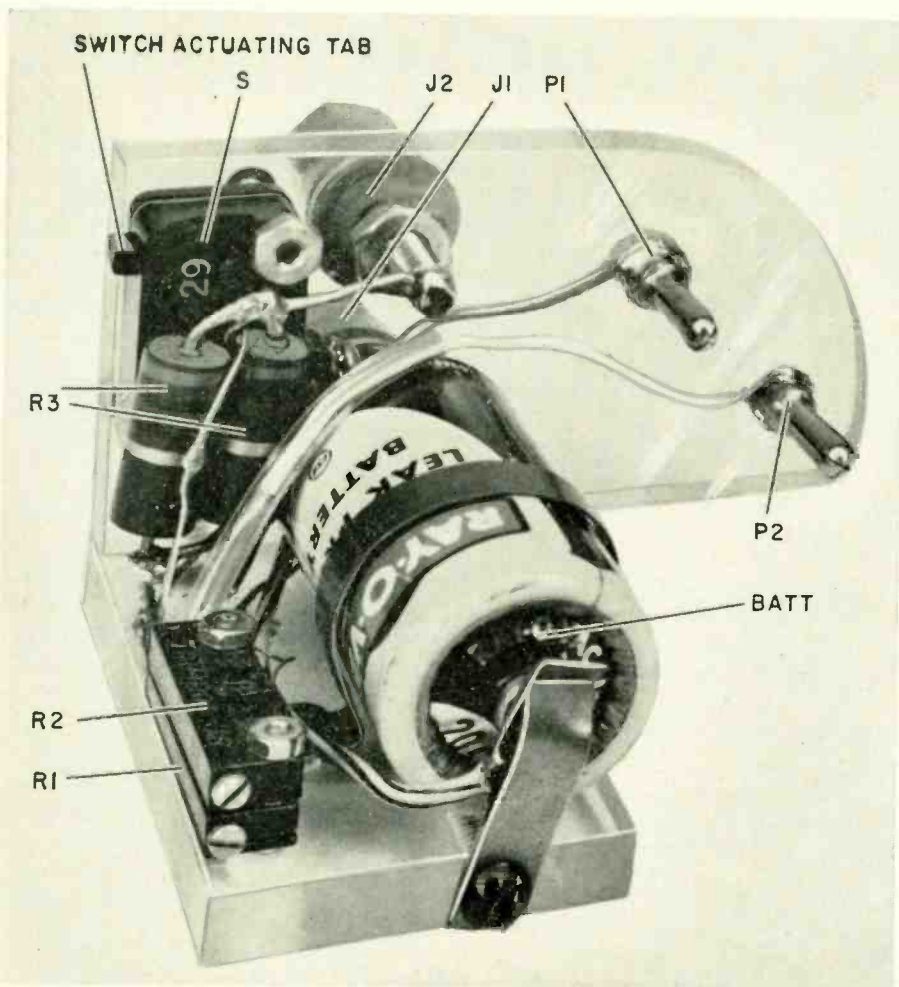

Top plate of Expander (the one that fits over the vom panel) is toward the back, carries plugs and jacks.

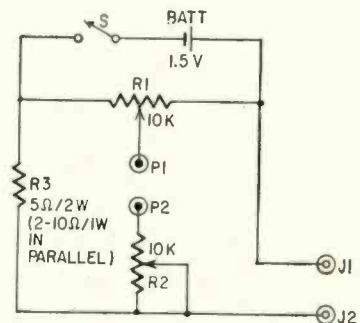

Fig. 1—Circuit of the Expander.

BATT—1.5-volt size-C dry cell
J1, J2—"5-way" binding posts
P1, P2—Banana or other plugs to suit vom
R1, R2—pot, 10,000 ohms
R3—5 ohms, 2 watts (or two 10-ohm 1-watt resistors in parallel)
S—miniature spst microswitch
Battery holder and plastic scraps

BENCH



TESTED

A Radio-Electronics editor reported: "Useful for indicating relative resistances of low value . . . Resistance as low as 1/20 ohm was easily detected. . . . Readings are not linear, so accurate standards are needed if the scale is to be calibrated."

"Resistance of short lengths of wire, poor connections, small-coil resistance, were easily detected. "Remember that large resistors across J1 and J2 will overload the meter."

the rough balancing on a milliamp scale.

Next connect a resistor of known value to the leads, close S1 and adjust R2 so that the vom pointer is on a major scale division. For example, set 1 ohm to read 6 on the scale. Lower values of resistance will read less on the scale and higher values more. When actual values, rather than comparisons, are desired, you must plot a curve of resistance vs scale reading, because of nonlinearity.

Connect test leads to the component being checked with strong clips or clamps so that contact resistance does not cause an erroneous reading. Close the switch only after the test leads are in place. Clips are better than probes

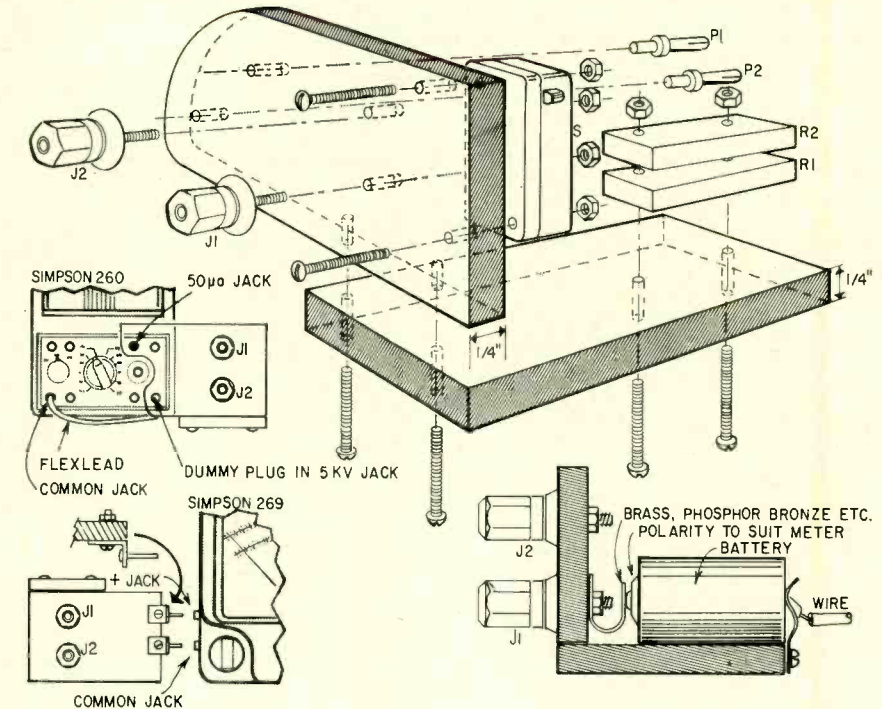

Fig. 2—Mechanical details of expander for Triplet 630. Contours are given for Simpson 260 and 269 volt-ohm-milliammeters. You may have to adapt the plastic pieces to your own meter.

since they leave a hand free for the switch and are not apt to slip and cause the meter to peg.

When you check resistors, locate "opens" with the vom on a high milliamp scale to prevent pegging. END

Knight-Kit KG-275 Exposure Meter

For manufacturer's literature, circle no. 25 on Reader's Service Card

WIRING UP SOME KITS THESE DAYS CAN be a major project, taking dozens of hours. This little Knight-Kit is refreshingly different—my 14-year-old daughter wired it and put it into action late one Sunday afternoon.

Calibration is also simple. A "battery test" button is pushed in and the meter indicator set to the point marked BAT on the scale by adjusting a potentiometer with a screwdriver.

To one who is used to an old-time exposure meter, the first and most striking thing about this one is the ease of taking a reading. A movable center disc has two windows for ASA readings (one for straight ASA; the other for ASA°) and an arrow to which the meter reading is set. It is first positioned for the ASA number of the film used by moving it till the number appears in the window. Then one points the meter at the object to be photographed and presses a button on the side of the case. The meter reading (1 to 22) is noted, and the big outside disc turned till that figure coincides with the arrow marked METER on the center disc. This is done very easily with the thumb. This results in the usual alignment of stops against exposures.



The f/-numbers are on a fixed disc, and the exposure times on the large movable outside disc.

The meter is also calibrated in f/-stops against frames per second for movie cameras, and it has a window for the combination EV-LVS settings used on many modern cameras.

The instrument is made to work chiefly with light reflected from the subject. But it has a diffusing cap which is slid over the photocell opening for situa-

tions where it might be desirable to measure incident light.

The sensitivity of the meter is remarkable. There are two scales, each with a pushbutton switch. For indoor work the L (Low) button is pressed. It will give some reading in the darkest corners (the book says you can take readings by moonlight but I haven't tried that). The H (HIGH) pushbutton is good for the most brightly illuminated outdoor scenes.

A very interesting feature is the candlepower table in the Owner's Guide. Theoretically, any exposure meter can be used to measure absolute light intensity if one knows how. The table shows how to convert the meter readings to foot-candles. The range is fantastic, from .014 to 28,000 foot-candles.

The meter is shaped so that when it is held in the left hand pointing toward the subject to be photographed, the two buttons are conveniently under the fingers, and all adjustments can be made with the thumb.—Eric Leslie

MANUFACTURER'S SPECIFICATIONS

Sensitivity: low range, .014 to 28 foot-candles; high range, 28 to 28,000 foot-candles.
ASA film-speed settings: 6 to 12,000 (1° to 12°).
f/-stop settings: 0.5 to 64
Shutter-speed settings: 1/4000 sec to 30 min
Cine settings: 4 to 128 frames per second.
EV settings: -12 to +22.
Acceptance angle: approx 50°.
Color response: peaked at 5,600 A.
Photocell: cadmium sulfide.
Price: \$15.88.

the Old-Timer builds The INTERCOMBO

...and a bowling alley gets wired for sound

By JACK DARR
SERVICE EDITOR

THE YOUNG HAM DASHED IN THE BACK door of the shop, threw his school books on the shelf and gazed in astonishment at the apparatus on the bench.

"What in the world is that?" The Old-Timer looked up at him grimly. "Junior," he said, "remember that saying you guys had around school a while back—'Open mouth, insert foot?' Well, this is the result of some of it. I came down with a pretty bad case of foot-in-mouth disease out at the bowling alley the other day!"

On the bench was a small amplifier chassis. A front panel had been added. In its center an 8-inch speaker was fastened, behind a grille, and a wafer switch, with a tangle of wires leading down into the chassis. On the back apron, a terminal strip had been mounted.

"You gonna put that out at the bowling alley? What for?" asked the Young Ham.

"Well, I was talkin' with Jim the other day. He wants a sound system to call bowlers to the telephone, and so forth. So, I told him I could fix him up one.

"Next thing, he says, 'Wish I could afford an intercom system, too, so I could talk to the house.' You know, he

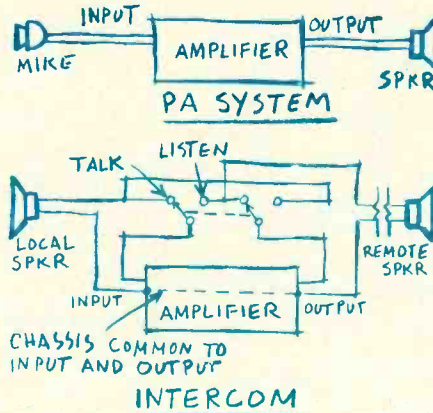

Fig. 1—"What's an intercom, anyhow? Just an audio amplifier, with a switch to change ends."

lives up there on the hill behind the bowling alley, about 400 feet. So, before I thought, I says, 'Why don't we add that to the same sound system?' 'Can you?' he asks. 'Sure,' I says. So, now I gotta do it! Wants an extra remote station in the back room, where the pinsetters are, too, so they can call him to the phone.

What's an intercom?

"But, golly, all that stuff on one

little chassis!"

"Actually, it ain't so bad. What's an intercom system, anyhow? Just an audio amplifier, with a switch to change ends on the amplifier." The Old-Timer sketched rapidly on a piece of paper [Fig. 1]. "See? A PA system is the same thing, without th' switches. So, you can combine the two!"

"I don't exactly dig this intercom system connection here," said the Young Ham, tracing the drawing with a little screwdriver.

"It ain't complicated, once you know what it's supposed to do," retorted the Old-Timer, indicating his sketch. "Look here. You got th' same amplifier. There's two speakers connected to it. One used as a speaker, the other as a mike. Right? In other words, one on the input, the other on the output. So all we have to do to make it work the other way is reverse the speakers."

"Yeah, now I see it," conceded the Young Ham.

Some simplifications

"All right, now here's what I've done. I put this two-deck wafer switch here on the panel. I'm gonna set this up a little different from an ordinary intercom system. I'm switching here in three positions: PA, Intercom Talk and Intercom Listen.

"First thing, I knew I had to switch my output lead. So I brought th' output transformer hot wire up here to it [Fig. 2]. Then, I knew I had to switch the input, so here's the mike input lead, here. To match that low-impedance speaker to the high-impedance input of this amplifier, I just stuck an old output transformer in here, and I'm using it for an *input* transformer! The 25,000 ohms impedance of the secondary makes a pretty usable match to the grid."

"After I got that hooked up, my intercom line comes out here. I had to use up one of th' extra contacts on the switch to break the circuit on that input transformer, where I marked the X, there, while the switch is in 'Talk' position. Otherwise, I shunted my output with that low impedance and lost volume. Now, I had to have a local speaker. So, I happened to think that I had two or three brand-new 8-inch speakers with

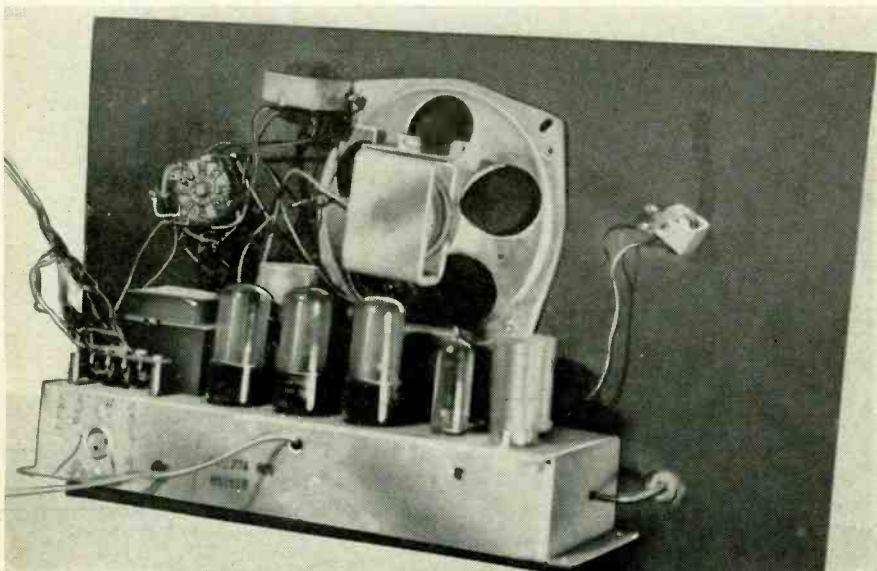

"You gonna put that out at the bowling alley? What for?"

a 1,000-ohm field that I got by mistake a while ago! Can't use 'em in anything else. So I hung one of 'em on here, took the filter resistor out of the amplifier power supply and used the field as a choke. Got a little more high voltage, and a heck of a lot better regulation, too."

"That speaker's just for intercom, is it?" asked the Young Ham.

"Yep. Doesn't work on anything except incoming calls. Instead of using the speaker as a mike, I thought I'd just go ahead and use the mike I already had hooked up. Saved a little on th' switching." The Old-Timer grinned.

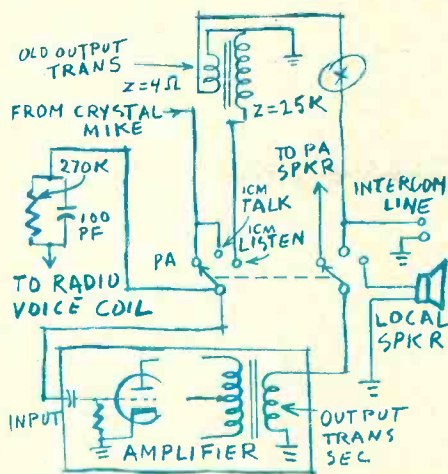

Fig. 2—"First thing, I knew I had to switch my output lead."

"Oh, yes, forgot another thing! He wants me to fix up a connection so that he can hook the alley's old radio to this and play music over the sound system! Wow! Anyhow, I did that a real cheap an' easy way! I just hung this little R-C network here right on the input. When we get it installed, I'll connect the hot wire from the radio voice coil to this, and he can use the radio volume control to set the level. When he wants to use the PA system, he just turns the radio down."

"Didn't you say that he was going to have two remote stations on this intercom system?" asked the Young Ham. "Where's the selector switch for that, or are you going to connect 'em both in parallel?"

"Could, if I wanted to. But I'll just use a little spdt switch to select either one of the two, since he's only gonna want the two stations. If there was more'n that, we'd have to hook him up a bank of pushbutton switches like a regular intercom."

"Yeah, we would," agreed the Young Ham. "Now, there's only one thing left to do—"

"Go gitta cuppa cawfee!" declared the Old-Timer, getting up. "After that,

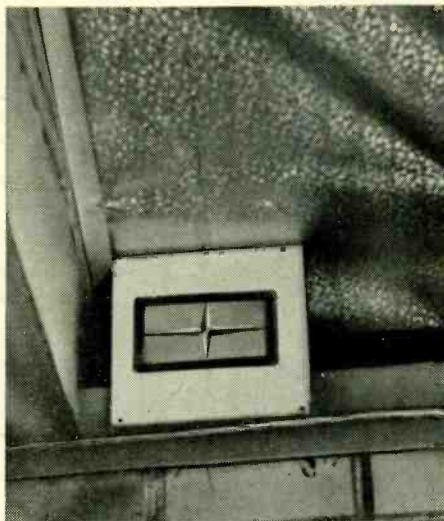

The Old-Timer's quick-and-dirty speaker baffle, installed in corner between wall and ceiling.

we can make a rash dash out there in the Bugg, and you can get to work."

"I can get to work?" queried the Young Ham plaintively. "What do you mean?"

"We're going to divide this job up, same as always," said the Old-Timer with a perfectly straight face. "Half an' half. I do th' brain work, you furnish the muscles!"

The fun begins

Once at the bowling alley, the owner met them at the door. "Did you get it done?" he asked.

"Yeah," said the Old-Timer. "Now all we gotta do is make it work! Didja find those tiles?"

"Got 'em," said Jim, producing a stack of Celotex tiles a foot square from beneath the counter.

The Old-Timer handed them to the Young Ham.

"Here, cut these out with the saber saw and then mount the speakers on them. You're about to see th' development of the Old-Timer's quick-and-dirty speaker baffle system!"

The Young Ham set to work, and the Old-Timer returned to the front. There, he installed the amplifier in the space under the shelf. As he finished, the Young Ham came from the back room, covered with sawdust, carrying the speakers. He set them down on the counter, and asked, "Well, what now?"

"I'll run th' intercom wiring up th' hill, and you hang the speaker wiring in here. Here, I want it run like this." The Old-Timer snatched a napkin and sketched a few lines. "See, I'm gonna run a three-conductor wire back along the wall to pick up th' first station on the intercom, then a two-wire over the ventilator at the back, over to that pole behind the alleys, then on trees up to the

house. You run the speaker wiring in two-conductor up here, across the partition, down the wall, an' then along this beam here to the other side. Tack it up with insulated staples. Got it?"

After about an hour, they both met in front of the lunch counter, and said simultaneously, "About time for another cuppa cawfee, ain't it?" laughed, and sat down. "Now, tell me about this deal," said the Young Ham. "What's all the little speakers for? Why don't we use regular PA speakers?"

The Old-Timer grinned at him. He got up and went over to the approaches to the bowling alleys. This was a quiet time of the evening, and no one was bowling. He clapped his hands together sharply. "WHAP-APP-APP-app-ap-ap-ap-ap-ap-ap" came the echoes from the tile walls and hard floors. "Hear that?"

"Yeah, but what's that go to do with it?" asked the Young Ham.

"Considerable," answered the Old-Timer, returning to the counter. "This building has about the longest reverberation time I ever saw! That makes a heck of a lot of difference in the way you supply sound coverage to it!"

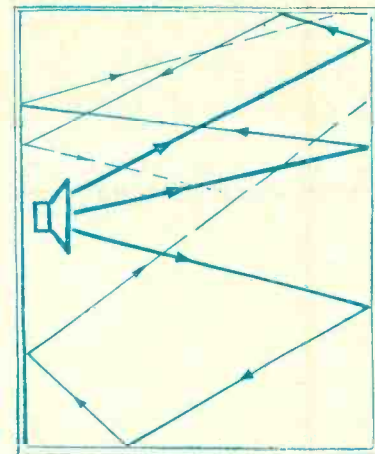

Fig. 3—"You hear the first wavefront comin' out of the speaker, then you keep on hearin' it for five seconds! . . . In the meantime, you've got lots of other sounds comin' out of that speaker . . ."

"How come?" the Young Ham wanted to know.

"Well, for instance, we put in one big speaker, right about where we're settin'. If we put a high enough level on it to get sound out there on the approaches, we'd get strikes on the first three alleys every time we pushed the mike button! To say nothin' of deafenin' everyone in th' place. Worst part of it, though, you put a single loud sound source in a building like this, and you get echoes."

"Look here. [Fig. 3] You hear the first wavefront comin' out of the speaker,

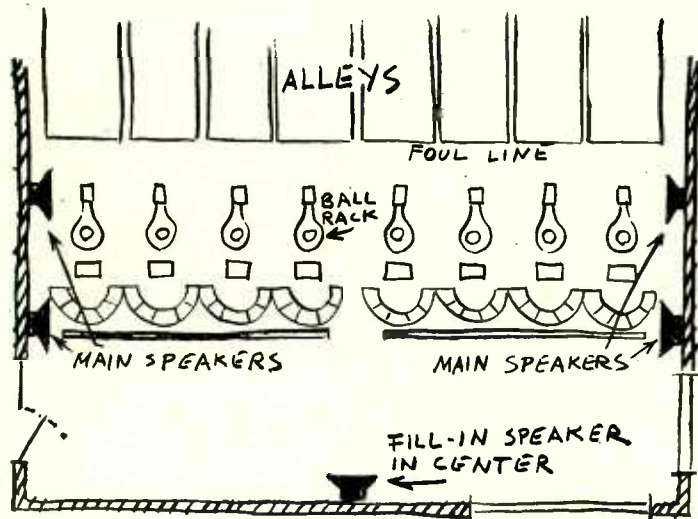

Fig. 4—"We spread these small speakers around all over th' place, and we can drizzle sound all over."

then you keep on hearing it for 5 seconds! That's how long it took the sound to die away when I clapped my hands just now! In the meantime, of course, you've got lots of other sounds comin' out of that same speaker. Each one of 'em takes 5 seconds to die out! You wind up with a mishmash of sounds that you can't read at all! Sounds like the 20-meter phone band on Saturday night!

"Now, what I want to do is this: We take these small speakers. Each one of 'em will carry at least 2-3 watts. We spread 'em around all over th' place, like so, and we can just kinda drizzle sound all over [Fig. 4]. Be like the difference between gittin' hit in th' face with a firehose and a lawn sprinkler, see?

"We take these baffles you just

made, and stick 'em up against the ceiling, pointing 'em slightly downward, and we oughta get pretty good coverage.

"Hey! Wait a minute. Darn near forgot somethin'. I see trouble ahead! Dead spot, right here," said the Old-Timer, pointing to the center of his floor-plan sketch [Fig. 4]. "I know without even tryin' it out that we won't have enough sound out in there. What with guys yellin', pins fallin', we'll need some help out there. Let's put one speaker in th' middle. Hang it on th' back of the beam, where your wires are running. Face it as near to straight down as you can."

While the Young Ham fastened the speakers in place, the Old-Timer hooked up the intercom wiring and checked it out. As he finished, the Young Ham

came up to the counter. "Well, that's that," he said. "Got 'em all hooked up."

Slight case of mismatch

"Good. Now, let's try 'em out." The Old-Timer turned the amplifier on, plugged in the microphone, and said, "Hello, test, one, two, three, four." The sound system was very quiet! He looked at it, puzzled, then a light dawned. "Hey! How'd you hook them speakers up?"

"Hah? Like anybody would, I guess. In parallel."

"Well!" sighed the Old-Timer in relief. "That accounts for it! Look. What's the impedance of those speakers?"

"Four ohms?" suggested the Young Ham.

"Four ohms," echoed the Old-Timer. "What's 5 times 4 ohms in parallel? About point 8 ohms! The output of the amplifier is about 16 ohms, so I'd say that we had just a wee mismatch, wouldn't you? Now, go hook 'em all up in series! That way, we got a match. Actually, this gives us 5 times 3.2 ohms, which is the nominal impedance of these speakers, and that 'hain't far from 16 ohms."

The Young Ham went back up the ladder and reconnected the speakers as the Old-Timer suggested. He was just coming down from the last one when the Old-Timer called, "Hey, wait a minute! While you're up there, let's phase 'em. Here. Watch the cone of the speaker." And he pulled his penlight from his pocket, took out one of the batteries and applied it to the speaker wires, which he had disconnected from the amplifier. "Move in or out?"

"In," said the Young Ham, watching the cone.

"Good. Remember, *in*. Now, go to the other one on that wall." The Young Ham did. The Old-Timer applied the battery again. "In or out?"

"Out," replied the Young Ham.

"Reverse the wires," said the Old-Timer. They phased all the speakers. The Old-Timer turned the mike gain up again, and was rewarded by a deafening feedback howl.

He grinned and turned the gain down. "Here, Bettie," he said, handing the mike to the owner's wife. "Try it out."

She took the mike as if it were alive, and looked helplessly at him.

"What'll I say?" she asked. The sound system repeated her words loudly, and she jumped. "I don't know what to say!" she repeated.

The Old-Timer grinned quizzically at her and Jim. "Y'know, this is some kind of a record, I think! First time in my life I ever saw a woman with a chance to say something and couldn't think of anything to say! Maybe we better leave on that!" He and the Young Ham quietly folded their ladders and departed.

END



"What'll I say?" she asked, and the sound system repeated her words loudly."



Hybrid auto sets are part of a day's work at many shops.

Ten Transistor and Hybrid Auto-Radio Troubles

Hints for servicing auto radios with transistor audio output stages

By HOMER L. DAVIDSON

IN THE PAST FEW YEARS, THE CAR RADIO has changed a lot in looks and construction. We used to have reliable trouble, like a defective vibrator, bad 0Z4 or a shorted buffer capacitor. Of course when we put in a new vibrator, we had to change the buffer. Nine times out of ten, the 0Z4 rectifier was changed at the same time. We could bet that the biggest trouble was in the power supply.

Today, the vibrator has been replaced with low plate and screen voltage tubes that work on 12 volts, and a power transistor as audio output. We don't have to worry much about vibrator or buffer replacement any more. Now, auto radios are coming out with small transistors instead of tubes. We must now tackle a new way of servicing, as we did when the small portable transistor radio came in.

I stood on my head and pulled out

a Chevy II car radio that had a noisy front end and sometimes faded out on the high end of the dial. When I pulled off the cover, I could spot one trouble right away. The antenna coil had shaken loose from the mounting and broken off at the antenna terminal. The customer said that he could barely hear the local stations, and the rest of the dial was noisy. I repaired the antenna coil and snapped it back in place.

The radio was left to run on the bench. In about a half hour the local station (at 1400 kc) faded out. Turning the dial toward the lower end, stations came back in at 1200 kc. I found that the local oscillator dropped out at that frequency. The DS-25 transistor was replaced and the radio was OK again.

It is best to replace all transistors with original units, if possible. This

Delco DS-25 was replaced with an original, but since then I have replaced them with a GE-1.

The next car radio was a Mopar model 624—intermittent. Intermittents will sometimes act up in the car, but when you get them on the bench they play like angels.

By pressing up, down and sideways on the second i.f. coil, I could make the radio cut in and out. You can sometimes locate an intermittent by pushing and prying on components, or on the board itself. You can find a primary-to-secondary-shortened i.f. by checking the voltage on the secondary. Sometimes it will kick up and down, but it should never go positive there.

The second i.f. transformer had to be replaced. In this model, the board is printed on both sides and a lot of heat must be applied to the soldered coil lugs. (I haven't replaced one yet that came out real clean.) It seems that the printed wiring wants to tear off on the top side (Fig. 1). Use special care here, and a good soldering iron.

On boards with printed wiring on both sides, I take a small piece of stranded wire and push it through the transformer lug holes and then replace the transformer. Twist the stranded wire around the coil lugs and make a good soldered joint to the printed board on the bottom side. By doing this, you never risk a bad soldered joint on the top side. Fig. 1 details this technique. Some of these coils are in very tight places and the smallest soldering iron cannot do a good job beside the metal can.

I checked the coil's resistance after it was installed. After the radio was fixed and working, the second i.f. was checked for correct alignment.

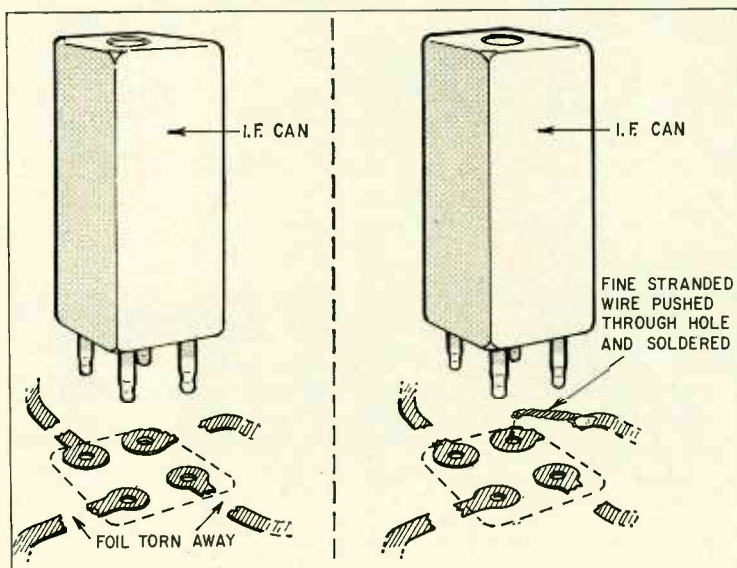

Fig. 1.—(left) How and where foil tears on this Mopar 624. (right) Technique for solving this problem. See text.

Next was an Oldsmobile radio, also intermittent. This was a Delco model 989170. When the dash of the car was tapped, the radio cut up and down, and did the same at every bump. This turned out to be a fairly easy job.

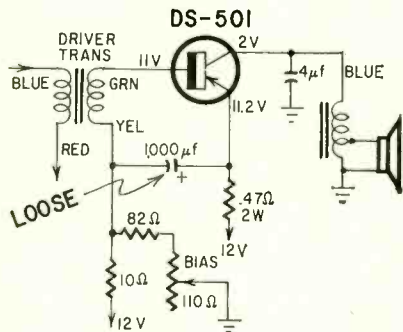

Fig 2—Output stage of Olds model 989170. Indicated capacitor hangs away from circuit board, can work its connections loose.

One of the capacitors that hangs out in space didn't have a good soldered joint. Fig. 2 is the circuit of the intermittent portion.

Several of the same models have intermittent first i.f. transformers. If a Delco part isn't handy, a Workman T-655 does a nice job here.

Another intermittent auto radio was brought into the shop and the owner described the trouble: When the radio was bumped or the car driven over rough roads, the radio cut off completely. The same thing happened when it played on the bench. There was no sound, no hiss, no hum, nothing. Right away I knew it was in the transistor output stage.

Looking a little closer, I found that the connection to the output transistor collector was bad. You could just wiggle the wire and the radio would go in and

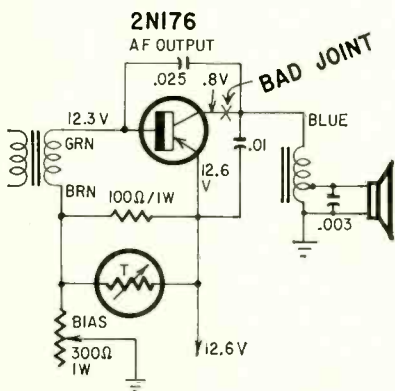
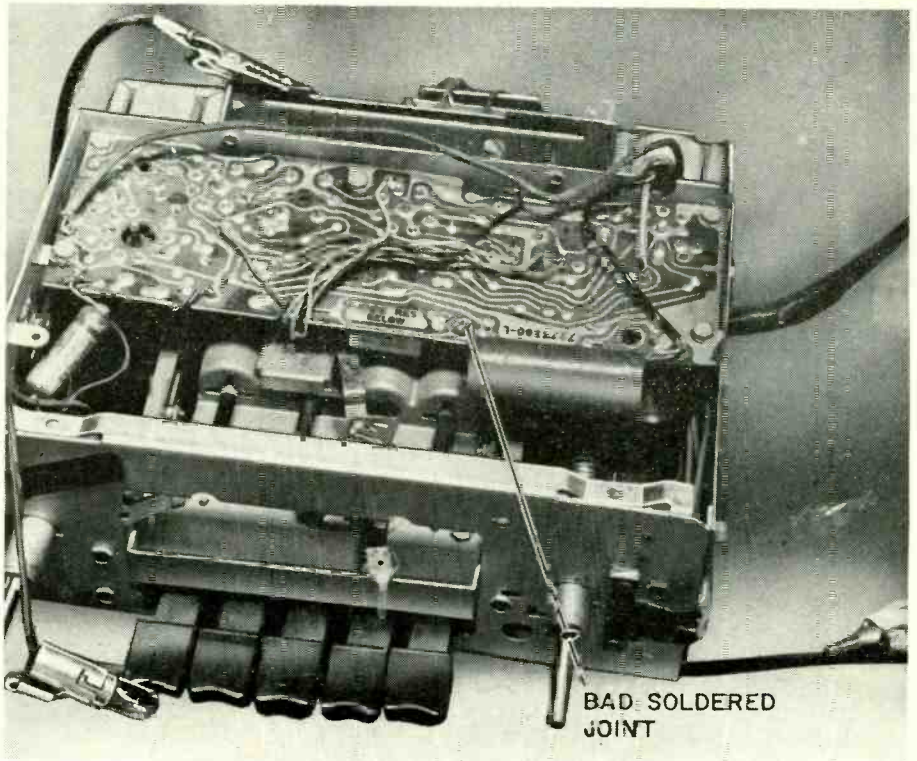

Fig. 3—Output circuit of Motorola 311X. Bad collector connection caused intermittent sound.

out. This was a Motorola 311X universal under-dash car radio. Fig. 3 shows the point of trouble in the schematic.

One of the biggest troubles in hybrid car radios is the power transistor.



That hanging 1,000-µf capacitor of Fig. 2—this is where it disconnected itself.

A Mopar model 848, manufactured by Philco, came into the shop with no sound. There was a click in the speaker when the switch was turned on, but no music. You could smell something getting hot, and the 0.27-ohm emitter resistor was burned. The 15-ohm bias resistor would get quite warm. The power transistor, it turned out, was shorted, so I replaced it. When in doubt, always replace the bias resistor, especially if it seems too hot.

The power transistor was a Philco

AR-10, and I didn't have one handy, so I replaced it with a GE-3. But since the original transistor had pigtail wires, these had to be soldered to the connections on the replacement transistor. Cut the wires from the AR-10 transistor as close to the body as possible. All but one of the wires were long enough; a new wire was used for the short one. The transistor bolts into the same place as the AR-10.

With an ammeter inserted in series with the collector lead, I adjusted the

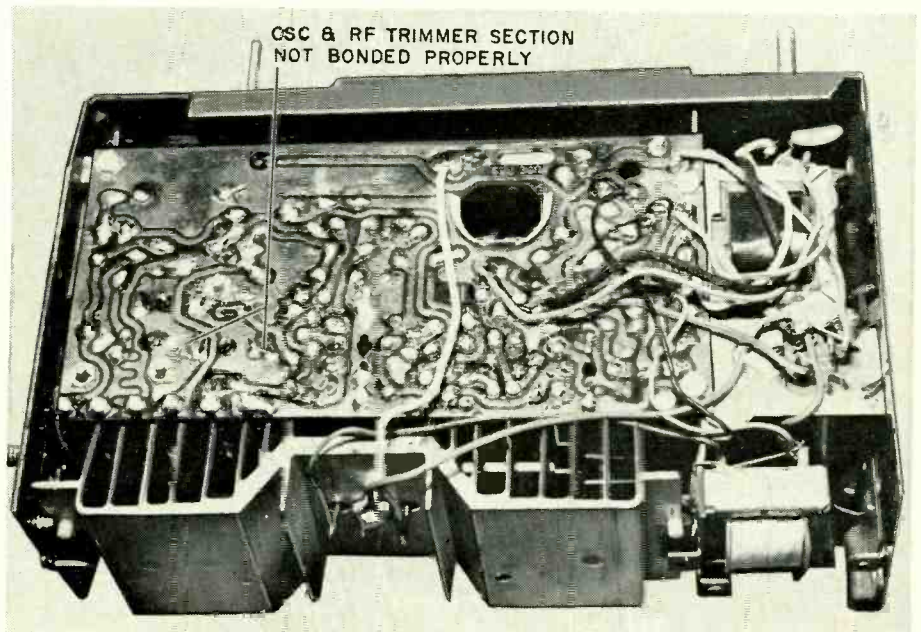

In this Delco 983873, the oscillator and rf trimmer assembly was making poor contact with the rest of the set.

bias resistor for 550 ma. Another method is to use a voltmeter and adjust the bias resistor until you have a 0.95 volt dc drop across the primary of the output transformer. Use the 2.5-volt scale here. It is always best to readjust bias when an output transistor is replaced. Fig. 4 illustrates the circuit.

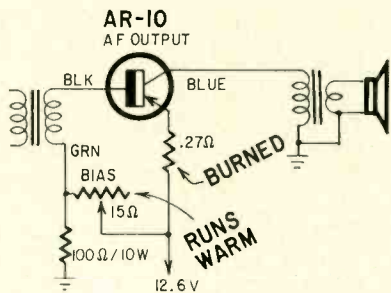

Fig. 4—Audio output of Mopar 848. A burned emitter resistor almost always means a shorted output transistor.

A Chevy model 988414 was pulled. No volume. The tubes checked OK and the 0.33-ohm resistor was burned out. The output transformer was running warm. A shorted Delco DS-501 power transistor was the culprit. Replace this transistor with a Delco unit if handy. If not, use a GE-4 power transistor.

Insert an ammeter in series with the collector lead and adjust the bias resistor to read 670 ma at 12.6 volts. This lead is the blue one from the output transformer. Fig. 5 is a schematic of the power transistor circuit.

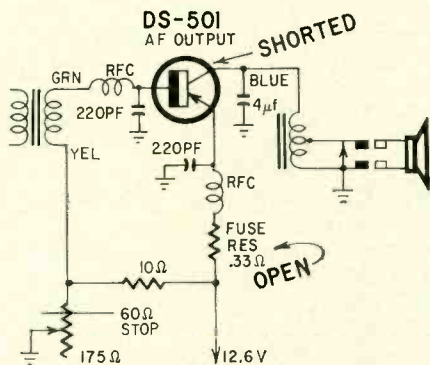

Fig. 5—This Delco 988414 also had a shorted output transistor.

The complaint on the next Delco model 983873 auto radio was that it would go off stations and that the sound became distorted. You could push up and down on the etched board and make it happen. The bonding bolts that ground the etched board to the metal framework were loose. Since the music became distorted no matter where you pushed on the board, the whole board was resoldered.

Still the same thing happened. Looking over the whole chassis from part to part, I found that the trimmer capacitor lugs were not bonded properly. A big iron was used to solder the whole

oscillator and rf trimmer assembly to the etched board. I let this radio run on the bench for two days continuously to make sure there were no more bad joints. The radio is still working.

A Chevy model 985332 radio was next in line. A station came in sometimes, then nothing. I turned on the radio in the car and the speaker clicked. Then, with the volume full on, I heard a loud rush. I knew from this that the audio, i.f. and rf stages were working. But when the dial was turned clear through one way I could not get a station. When the dial was turned back, I heard a station for a moment.

The car radio had to be pulled. I told the customer to leave it, because the trouble was in the oscillator circuit. It wasn't too hard to find—the oscillator tuning slug was broken off. It is still a mystery how some of these slugs break off *inside* the coil. I have had it happen before in quite a few car radios.

The last hybrid radio is a Motorola CTA9X pushbutton job. The customer

complained that at first the radio would cut up and down in volume, but was now completely dead. The radio, naturally, had to be pulled. The fuse was checked in the car and was OK, but none of the tubes were lighted. The on-off switch was bad; that eliminated one trouble. Temporarily, a wire jumper was clipped across the switch connections. The bottom plate was pulled off and pressure applied to the board. Since i.f. transformers cause a lot of intermittents, they were checked. By pushing on the prongs of the second i.f. transformer, I made the radio cut out and in. I replaced the transformer.

Have several types of on-off switches available for replacement. In some cases these switches are hard to pull off the back of the volume and tone control, and the whole unit must be replaced. If a correct switch is handy, push the tabs through the old control's back plate and solder around the switch edge. Use soldering paste here—a good strong bond is needed. **END**

TWENTIETH-CENTURY TOILET TRAINER

Switchcraft, Inc., makers of switches connectors and other electronic devices, recently filled an order for 5,000 single-contact normally open switch-leaf assemblies, which will be used by the Creative Monitor Co. in what Switchcraft calls "one of the most unusual switch applications we have heard about so far."

Creative Monitor is manufacturing a baby's potty chair called the "Baby Biffy." But this is no ordinary potty chair. In keeping with 20th-century technology, it is equipped with an indicator light that glows when something has been deposited in the potty.

According to Creative Monitor, it is psychologically harmful to the child for the mother to lift him to see if anything has been deposited.

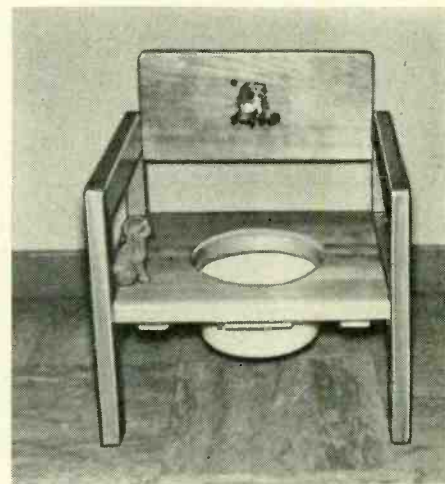

With the Baby Biffy, that's not necessary. When a half ounce or more is in the pot, the container's delicate balance is upset, closing the switch contacts. This lights a bulb enclosed in a toy plastic dog on the side of the chair. When the dog lights up, mommy knows her little one is finished. And the illumination is an incentive to the infant to produce.

Radio-Electronics Is Your Magazine!

Tell us what you want to see in it. Your suggestions may make it a better magazine for the rest of the readers as well as yourself. Write to the Editor, RADIO-ELECTRONICS, 154 West 14th St., New York, N. Y. 10011. **END**



Make a Variable Electrolytic

Aluminum mesh-plate trimmer plus a few cheap chemicals in a plastic jar make a continuously variable capacitor with values to 200 or 300 μf

By TOM JASKI

THE ELECTROLYTIC CAPACITOR CROWDS a large capacitance into a small space because its dielectric is extremely thin. This dielectric is a layer of oxide "formed" on the aluminum-foil electrodes. The electrolyte partially dissolves the oxide, but new oxide is formed every time the capacitor is put into use.

This rather simple description of what goes on in an electrolytic capacitor will do for our purposes. More detailed descriptions can be found in the literature.

We can make a variable electrolytic capacitor by mounting an ordinary air variable capacitor in a water-tight container, adding the proper electrolyte and "forming" our capacitor by passing an electric current through it. Even a small aluminum trimmer (see photo) makes a good-sized capacitor. A 100-picofarad trimmer should become a 50-microfarad capacitor, variable from about 15 to 50 μf .

Begin with an aluminum-plate variable capacitor. Make sure that the plate supports are aluminum as well. Some trimmers on surplus variables, and even the capacitors themselves, are made

entirely from aluminum. But look out—many are silver-plated or cadmium-plated brass.

Mount the capacitor in a plastic container. The simplest way is to mount with the shaft upright as in the photo, but if you must operate with the shaft horizontal, make sure you have a water-tight seal around it. Bring out connections—as short as possible. Leave a vent in the case—it can be plugged up after the capacitor has been formed. If any of the supports or connections that will be immersed in the electrolyte are not aluminum, paint them carefully with acid- or base-resisting paint. Printed-circuit resist paint will do very well.

The electrolyte

The electrolyte is potassium hydroxide (KOH) and a little bit of aluminum acetate ($\text{Al}(\text{C}_2\text{H}_3\text{O}_2)_3$). Potassium hydroxide may not be readily available locally, but fortunately it is easy to make. You can probably order it from such firms as Central Scientific Co., 1700 W. Irving Park Blvd., Chicago, Ill.; Fisher Scientific Co., 633 Greenwich St., New York, N.Y.; W. M. Welch Scientific Co., 1515 N. Sedgwick St., Chicago, Ill. or Winn Scientific Co., 124 W. 23rd St., New York, N.Y.

Aluminum acetate can be found in drug stores as an astringent powder for wet compresses against skin irritations. Ask for Domeboro powder packets, made by Dome Chemical Co. Dissolve one packet in a pint of water.

To make potassium hydroxide, obtain some potassium chloride. This can be bought as part of the little SAF-Test

chemicals made by Perfect for hobby sets, and is available in most hobby stores. It can also be purchased as a salt substitute for low-salt diets.

Dissolve the potassium chloride in distilled water and pass a current of about 500 ma through it. Chlorine and hydrogen gas are produced, so work in a well ventilated space. When no more chlorine gas bubbles come up, you have KOH.

Electrodes can be platinum or pure carbon. You can make pure carbon electrodes by removing the center rods from old dry cells and glowing them out by heating bright red in a gas flame.

Now reduce the KOH solution to half-strength with distilled water, add just a few drops of the aluminum acetate solution, and filter the mixture (use glass funnel and chem-lab filter paper) before adding to the capacitor.

Forming the capacitor

This is done by passing a current through the capacitor and the electrolyte. The current should be about 1.5 to 2 amps per square inch of stator plate area. If you use the kind of small trimmer I did, with a maximum stator width of $\frac{3}{4}$ inch and semi-circular rotor plates, each plate is about $\frac{1}{8}$ square inch in area on each side.

The stator is connected to positive, and will be the plus side in the completed capacitor. During forming, some hydrogen gas is developed, so, again, be careful to work in a well ventilated space.

Forming is completed when the current drops to about 10 to 100 microamps (for the size capacitor I used). Also, the gas will no longer bubble off.

We cannot be specific about forming. The required voltage depends on plate spacing, concentration and purity of the electrolyte and the cleanliness of the plates. (They must be *very* clean and *greaseless*.) The actual forming is done in a fraction of a second—building up extra oxide takes a few hours. What you should see is a high current, dropping rapidly to about 10 to 100 ma (depending on size) which should then drop slowly. When it has dropped to "leakage" current (microamps for a good capacitor, but up to 1 ma for say 300 μf) the forming is complete and the capacitor will withstand a higher voltage. The forming polarity is the same as the final polarity. Sustained high current indicates the plates have been shorted. Failure to obtain current above "leakage" even initially indicates lack of voltage for forming. Start at 2 volts, increase to whatever is needed for reasonable current. Leave there for a few hours. Once in a while rotate the plates. If there is a precipitate, the KOH is reacting with something in the water or some coating on the plates.

Aluminum acetate and potassium hydroxide are both available from Winn Scientific Co., 124 West 23 St., New York, N.Y. 10011. RADIO-ELECTRONICS has arranged with them to supply 4 oz. of each chemical, postpaid, for \$3. (Check or money order must accompany order.) Please mention RADIO-ELECTRONICS in your order.



The ingredients and the finished product: potassium chloride (used to make the hydroxide), aluminum acetate, a small all-aluminum variable capacitor; and a finished, formed variable electrolytic.

The August Editorial

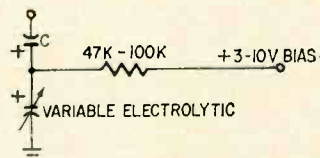

Fig. 1—How to use the variable electrolytic in a circuit. In this configuration, ac can be safely applied to the series pair. (Ac peak voltage must not exceed either capacitor's dc working voltage.) As transistor emitter bypass, variable can be used without any extra parts for biasing.

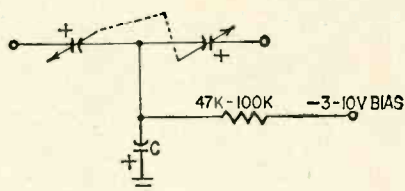

Fig. 2—A dual-section variable electrolytic can be made with a dual air variable. Useful for low-frequency, low-impedance filters, twin-T networks, etc. Bypass C is needed only when center point of capacitor must be at signal ground.

Application

This type of capacitor must be biased. In many applications the bias is automatically applied through the circuit. But in other applications, the capacitor will be used in series with others. In that case the circuit of Fig. 1 can be used. This allows you to apply ac to the two capacitors. A dual capacitor for a twin-T network can be made, and is connected as in Fig. 2. When used as a cathode or emitter bypass, of course, additional bias is unnecessary.

The capacitor will withstand about 15 volts dc working, and the final capacitance depends on the original unit. A 365-pf air capacitor can become a 200- to 300- μ f electrolytic capacitor, depending somewhat on its construction.

There are numerous uses for such a capacitor. One is an experimental circuit to determine the optimum value of an electrolytic capacitor, especially in transistor circuits where large capacitors are common. You can also use it as a true variable in adjustable frequency-determining networks for very low frequencies. Timing circuits, slow sweep circuits, phase-shifting circuits—all are possible applications for a variable electrolytic capacitor. END

REFERENCES

Pender & McIlwain, *Electrical Engineers Handbook*, "Communication"; New York: Wiley, 1956.

Handbook of Physics & Chemistry, 31st edition. Cleveland, Ohio: Chemical Rubber Publishing Co., 1955.

Aldis Shockinger, "Der April-Drehko—Ein Elektrolyt-Drehkondensator für sehr hohe Kapazitätswerte"; *Radio und Fernsehen*, April 1964, heft 7.

Dear Editor:

For a great many years the Editorial Page of RADIO-ELECTRONICS has been a favorite with me. I'm confident my opinion is shared by many thousands of readers. The August guest editorial violates many of the high standards of excellence established in the past. It is misleading, erroneous, and a disservice to your readers.

The editorial purports to present "Electronics and Programed Instruction". If there was any doubt about the precise nature of the coverage, the editor clearly spells it out in the first paragraph (an excellent example of good editorial style). He says, "It has been established beyond a doubt that machines themselves contribute little to the learning process though they will eventually make a great difference in the organization of curricula. . . . What then is programed instruction—the heart of this new teaching method?"

There follows a concise presentation of the educational theory of bite-sized learning steps, active student participation, immediate feedback and reinforcement, and the value of proceeding at a pace set by the student. It is then pointed out that, "Few of these conditions were realized in your high school days, and even fewer if you attended lectures at a university. The correspondence student is an even worse case. He struggles along by himself, sometimes weeks, to find out if he did answer correctly, and if not, what the correct answer is."

This is irresponsible use of the editorial page. As head of this school (Cleveland Institute of Electronics) and President of the National Home Study Council, I take strong exception to both direct and indirect implications of such a statement. Many accredited home study schools are using programed instruction in their lesson presentations . . . and have been for years. The enclosed group of representative CIE lessons is proof of this. Other schools have developed comparable techniques.

The writer then says, "Programs avoid this kind of problem . . . The student . . . can't help but learn . . . if it is a good program." This is fundamentally true, but having damned the correspondence school in the preceding paragraph, why not point out that many such schools have programed courses? In fact, why not recognize that good home-study school lessons have been programed for 50 years or more? The current fad has put the technique in focus and helped to polish skills, but the basic principles of programed instruction were built into home study lessons

long before Crowder and Skinner and even before Pressey.

While we're at it, let's not forget one of the greatest pitfalls of straight programed instruction. The technique has very definite limitations. For teaching a new concept or relatively short procedure, straight programing is good. However, for longer technical matter (such as electronics) or for areas where the learner already has some background in the subject, the programed approach is self-defeating. The material is very poor for review purposes. It normally has one beginning and one end. Furthermore, it does not, in many cases, permit the student to set his own pace. He must "lock-step" all the way through the bit-by-bit presentation and patiently wade through the participation and reinforcement, even though he already knows the principle involved or is a quick learner.

Finally, one last question. After setting the theme for his editorial (the technique, not the hardware), why did he devote 50% of his valuable space to a rather meaningless and limited discussion of how computers can be used with P.I.? Or to put it another way, when he conceived the title of the editorial, did he intend to discuss how P.I. could be used to teach electronics . . . or how electronics could be used to help present P.I.? With all due respect, he has done a poor job no matter which approach was intended.

G. O. ALIEN
President

Cleveland Institute of Electronics
Cleveland, Ohio

[We regret any misconception that may have been created by the August editorial. Both the late Tom Jaski and the editor were well aware that programed instruction is available from many correspondence schools. So well aware, in fact, that it did not occur to either that many readers might not know it. For the record, RADIO-ELECTRONICS printed a short article on the subject ("Home Electronics Study Takes a Step Forward", Sept. 1963, page 31).

The main purpose of the editorial was to point out the role of electronics in programed teaching. On page 6 of our March issue we described an ambitious system, Educating. It can use television-FM broadcasting to add the advantages of programed instruction to educational TV; or, by the use of tape, set up a complete programed electronic home-study system. The part that electronics will play in all types of education will, we believe, increase in importance.—Editor] END

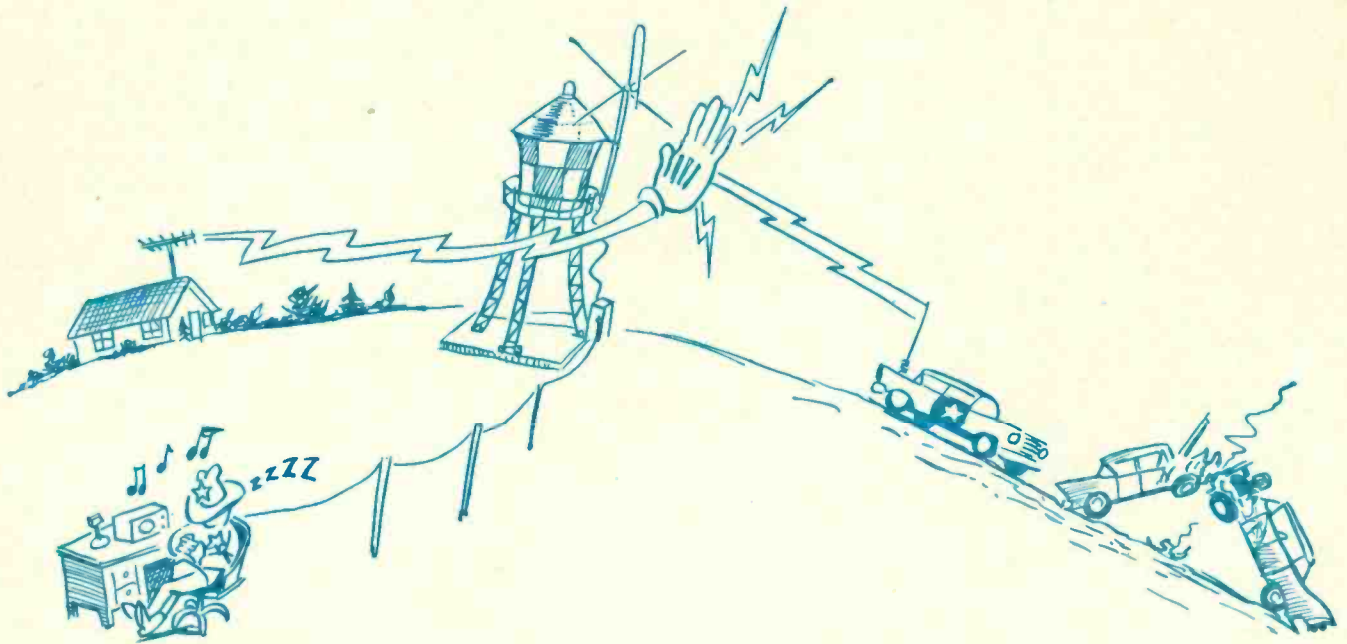

SPURIOUS RADIATION From 42-mc-I.F. TV Sets

Baffling interference to vital communications turned out to be power-line-radiated video i.f. signals

FOR THE LAST 2 YEARS, LANCASTER County Sheriff Merle Karnopp (Lincoln, Neb.) has had to put up with interference in the form of television programs on his 39.9-mc receiver, sometimes for hours at a time. Just about every method of suppression known to the industry was tried. Until recently, the only discernible effect was the best-working receiver in Nebraska, and the only one with no intermodulation (image reception).

Things finally got so bad that the deputies started calling the shop and asking us to bring down a picture tube so they could watch the program. At this point, I decided this foolishness had gone far enough, and buckled down to work.

After a great deal of mathematical pencil-pushing, somebody in the shop mentioned 42-mc TV i.f.'s. The next few hours turned up a half-dozen models in which the sound signal in the video i.f. falls at or near 39.9 mc.

About the same time, a service call to Seward, Neb., brought in a complaint of another sheriff receiving intermittent bursts of TV sound on the same frequency. A survey made at a sheriff's association meeting at St. Paul, Neb., a few weeks later established that every sheriff at the meeting had the same problem to some degree, the severity

By EUGENE AUSTIN, WOLZL

apparently depending on the density of housing around the base station.

With that kind of evidence, the only recourse was a systematic door-to-door interference-chasing campaign.

But, having gone through my share of TVI problems with a ham rig, I was more than a little wary of just going up to a TV owner and saying: "Hey, Buster, your TV is causing us trouble!" So, I drew on past experience in running down other types of interference under similar circumstances, and worked out a method of approaching the residents within a radius of one block of the base station.

Nobody likes to be told he is interfering with his neighbor's radio reception. On the other hand, nearly every

Fig. 1—Power-line wiring across some TV chassis is major fraction of wavelength at 40-mc region. High-level video i.f. signals couple to it and radiate for many yards. Bypassing usually cures trouble.

such source of interference hurts the owner just as much as the neighbors. So, a door-opener pitch was worked out that went like this: "I'm the guy that maintains the sheriff's radio over there under the water tower. We're having a terrific problem with somebody's television set interfering with it. These things usually work both ways, so we're pretty sure the TV is getting as much interference as it's causing. Curing one trouble will probably cure both. May I check your TV?"

I deliberately picked a cold, snowy night so people wouldn't stand in the door and argue, broke out a clean shop uniform and started down the street with a borrowed 39.9-mc Handie-Talkie.

The door-opener worked perfectly. No suspicion, no arguments, excellent cooperation all the way.

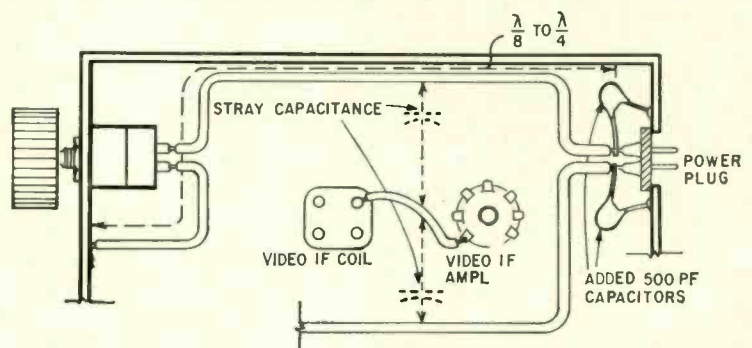

As expected, I found a TV that put about $1 \mu\text{v}$ into the sheriff's receiver from half a block away, when the fine tuning was in a certain position. Also as expected, the owner was having as much trouble with the sheriff as the sheriff was having with him.

Once again, I drew on past experience, partly to avoid giving the TV owner a chance to dodge the issue, and any legitimate reason to think we were just out drumming up business.

The TV owner was told again that clearing the interference out of the sheriff's receiver would probably help his picture. For a clincher, he was told that the FCC would hold the TV owner responsible for any interference his set caused, but that no one was going to make an issue out of a case where the owner was trying to clean it up, especially if the owner was not a technician.

Last, he was told that our shop did not work on TV sets, that we specialized in industrial electronics and lacked the equipment to work on TV's. I told him that we couldn't care less whom he called, just so arrangements were made for one of us to be there when the work was done.

This type of approach is effective 99% of the time. In this case, the TV owner had a technician there almost before we were ready for him.

The technical deficiency in this TV set has been found in others in this area, including at least five brand-new models sitting on the dealer's floor.

Fig. 1 is based on the usual mechanical arrangement, with the power plug mounted on the rear chassis apron. The wiring duplicates our particular set, an old hot-chassis clunker.

As shown in Fig. 1, the power leads are frequently an appreciable part of a wavelength at the i.f. With the chassis, they form an open stub, which closely approaches a quarter wavelength at 42 mc. The whole thing is like a quarter-wave antenna working against ground.

If this wire passes close to the high-level video i.f. stages, it is all too easy to couple 42-mc energy into this tuned line via stray capacitance. At that frequency, it takes only a few pf to make a tightly coupled rf circuit.

When this happens, the power line becomes one side of a radiating system, and the chassis, transmission line and antenna together become the other side. The tuner is effectively a short at 42 mc, thus grounding both sides of the transmission line to the chassis at the i.f. (Fig. 1).

A peculiarity shows up here when you find that disconnecting the antenna and using the built-in antenna drastically reduces the radiation. All you have actually done is reduce the radiating mass on one side. The easiest way to confirm power-line radiation is to reconnect the

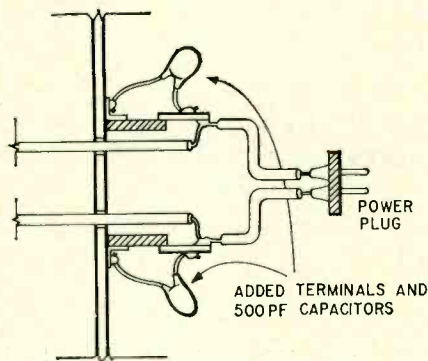

Fig. 2—Sometimes you will have to add terminal strips to connect bypass capacitors. Leads must be short.

outside antenna, through a high-pass filter. If the problem is power-line radiation, the high-pass filter will have no effect.

The solution is exactly the same as for any other device in which power-line radiation is the problem. Bypass the power line where it leaves the chassis.

If the power plug is located on the rear chassis apron, a pair of 500-pf disc ceramics connected at the power plug (interlock) terminals (Fig. 1) will suffice.

If you have a vertical chassis model in which the ac line wanders halfway across the cabinet before it dives into some inconvenient hole, add terminals and bypass capacitors where the wires enter the chassis (Fig. 2).

Do not use tubular paper capacitors. Even in small values, they are usually inductive at 42 mc. Use a disc ceramic, tubular ceramic or one of the other types specifically designed for vhf use.

In our case, adding these capacitors reduced the radiation from $1 \mu\text{v}$ at half a block to undetectable in a Handie-

Talkie less than 3 feet from the TV. It was interesting to note that bypassing the grounded side of the ac line reduced the radiation a good 10 db. After that, bypassing the hot side cleaned it up.

There are two other ways for i.f. energy to be radiated from the average TV. It can be coupled back through the tuner to the antenna circuit. In this case, an ordinary high-pass filter would probably suffice. If isolation were that poor, it would probably bring a noticeable improvement in picture quality, particularly near a 39.9-mc transmitter.

There is also a remote possibility of i.f. energy getting onto the video lead to the picture tube. This lead would probably be close to an electrical quarter wavelength at 42 mc. However, manufacturers take elaborate precautions to keep i.f. energy off the video lead, because of the picture degradation it would cause. The most probable cause of radiation from this source would be a defective component in one of the i.f. traps in the video amplifier circuit.

In this case, these two paths were closed, and adding power-line bypassing cleaned up the whole problem.

After clearing the interference from the sheriff's receiver, I took special pains to demonstrate the improvement in picture quality to the TV owner. Before the capacitors were installed, the sheriff's transmitter put a heavy herringbone on the picture and blanked the sound completely. It was highly annoying to the TV owner. Afterward, the sheriff's test transmissions showed a very light herringbone on the picture, and no effect on the sound.

The TV owner feels his \$11.50 was well spent. And we should have no trouble with any new neighbor who happens to move into the neighborhood with another of these "Leaky Lenas." END

BORED? LISTEN TO YOUR GLASSES

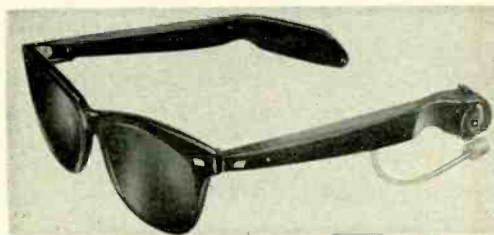

People who wear sunglasses are often accused of trying to conceal something. The next time you see someone with sunglasses and a beatific smile, eyes open and looking at nothing in particular, take a closer look at those sunglasses. There may be little knobs on each temple behind the ears, and a thin plastic tube from the left temple into the wearer's ear.

Hearing aid? No. Radio! A remarkably sensitive three-transistor radio. The radio is built into a pair of perfectly

plausible-looking sunglasses (one style for men, one for women) and powered by a pill-sized mercury cell good for up to 160 hours of playing. The frame is designed so that it can be fitted with prescription lenses by any optician.

The radio has a tuning dial (550-1600 kc), volume control and on-off switch, and a built-in antenna. It is imported by R. A. Schwarz International Services, P.O. Box 1218, Newport Beach, Calif., and others, and sells for \$25.95 postpaid in the USA.

Signaling Systems for CB Stations

Make your CB station as convenient as a telephone with selective calling

By E. L. SAFFORD, JR.

I RECEIVED A LETTER FROM A SOUTH American radio enthusiast recently. He asked "Can I construct a radio control that will let another person with CB equipment know that I want to talk to him?"

This can indeed be done with commercial equipment, but I don't remember seeing a home-constructed job for the purpose. After some thought and experiment I came up with a feasible solution. A simple relay circuit is connected to the receiver audio section. When a signal is received, the relay pulls in or drops out and energizes an alarm. The receiver of the CB station is always on, so the alert signal can be received at all times.

Circuit operation (Fig. 1) is simple. The audio, rectified in the base-emitter circuit, blocks transistor Q1 so the voltage rises at its collector. This makes transistor Q2 conduct, energizing the relay, which should be a sensitive type operating at about 1.5 ma. The operator at the distant transmitter can whistle or talk steadily in the microphone to produce a signal that will make the relay operate. The relay can be connected to a bell, buzzer or horn. When the person at the receiving end takes over he disconnects it and communicates normally.

In areas where there is much CB activity, a simple relay would be operated by any signals received. By adding a tone filter the relay circuit can be made tone-selective—it will operate only on one particular tone. A circuit of that type is shown in Fig. 2.

The tone filter is a parallel-resonant L-C circuit. When a tone to which it is tuned is received, the voltage across

Fig. 2—Amplifier with tone filter responds only when tone which corresponds in frequency to resonance of filter arrives at input.

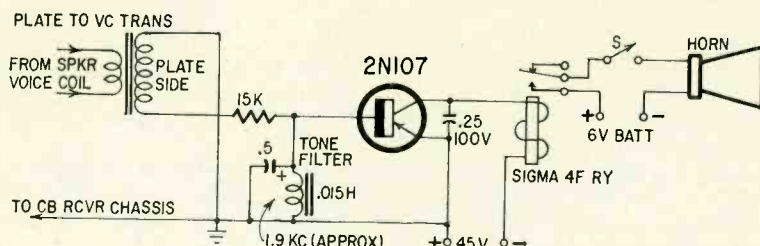

it rises. This makes the transistor conduct. If the resistance of the tone filter coil is large, the base-emitter current will not flow evenly, and the circuit will not work. So be sure to use a coil with a low dc resistance if you make your own filter.

This circuit requires very little adjustment. Connect the battery and feed

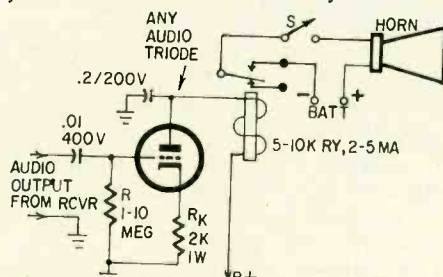

Fig. 3—Tube version of Fig. 1 uses any voltage-amplifier triode (6C4, 6AV6, 1/2 12AU7, etc.). R should be adjusted for proper performance. Use only enough plate voltage to pull in the relay when there is no signal. R_k may be 2,200 ohms, 10%. A test audio signal at the resonant frequency of the filter into the input. Adjust the relay so it closes with this signal. It is wise to vary the input tone above and below the filter's rated (or calculated) frequency, because that frequency may not be exact.

When the circuit is operating cor-

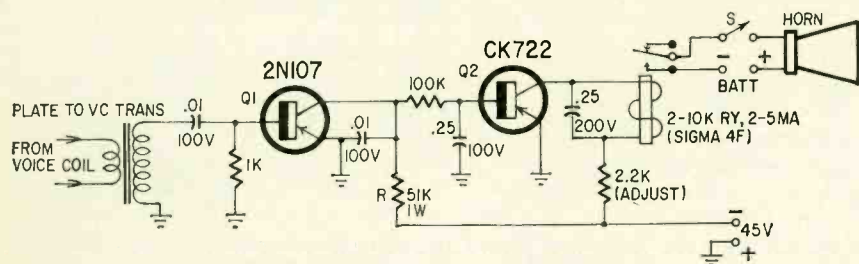

Fig. 1—Two-stage relay amplifier sounds horn or other alarm when audio appears at speaker. Any audio transistors can be used as Q1 and Q2. Resistor R may have to be adjusted for proper operation.

rectly the relay will remain open till the proper tone is received. It will then close and stay closed as long as *this tone* is fed into the circuit. You may have to experiment with the amount of tone voltage, and you will probably have to adjust the relay tension and contact spacing. To generate the correct tone at the sending site, you may have to construct a simple tone oscillator, adjust it to the right frequency, and feed its input into the mike input channel. Of course you will want to check it frequently to be sure it does not change its tone.

The simplest system

A non-selective circuit using a tube is shown in Fig. 3. This tube is biased by R_k so that it normally conducts enough to energize the relay. A strong enough signal will be rectified between grid and cathode, producing grid current. This produces a negative bias large enough to stop plate current flow, and cause the relay to drop out. The alarm is connected to the de-energized contact. It will now sound.

This type of circuit is useful because a power failure would de-energize the relay and sound the alarm.

Note that any signal of great enough amplitude—enough rf noise—will operate this relay. This circuit can be used only in quiet locations, and on CB equipment with squelch circuits so there will be no alarm until an actual signal is being received.

A tone filter may also be used with vacuum tubes, as shown in Fig. 4. Notice that with tubes the L-C elements are connected in series. The coil of this L-C circuit may have a fairly large dc resistance—up to several thousand ohms—because the tube operates with a voltage instead of current input. Battery-type bias is applied to the grid through the coil. This is overcome by the tone

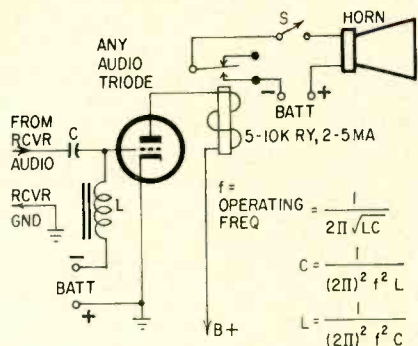

Fig. 4—Selective-tone tube circuit. Adjust bias so tube does not conduct when there is no signal.

to make the tube conduct. With this type of system the relay is normally deenergized until the correct tone signal is received.

A more sophisticated approach

A selective signaling system can be made with a reed relay. The various reeds which can be connected to other relays which can be connected to different types of bells or buzzers, or to bells and buzzers in different locations. Thus, different signals will call different people to the base transceiver. Since the reed relay requires only audio to operate it, it is also simply connected to an audio output from the receiver (Fig. 5). When a tone signal at the resonant frequency of any reed is received, that reed vibrates, closing the circuit to the relay intermittently. To keep the relay closed

when the reed is away from its contact, a short-time-constant R-C holding circuit can be used. It is connected across the reed contact, as shown.

The input for the test circuit in bottom photo was obtained direct from a signal generator. There were no adjustment problems which were not easily solved. It was necessary only to use the correct tones—these are critical. For reed units of the type shown the operative frequencies are roughly from

150 to 300 cycles, and you must be within a couple of cycles of the reed's frequency to make it work. The Sigma 4-F relays had to be adjusted so that they would close at about 1 ma, but once adjusted the circuit operated perfectly. Use an audio oscillator and get everything just right before you try to operate it from another station. And check the tone generator at the transmitting station frequently.

With selective signaling, you can call anyone of several stations by sending the right tone, or you can call a specific person at a specific station. People at each end of the system do not have to be within earshot of their speakers. END

References

- E. L. Safford, Jr., *Model Radio Control* (Gernsback Library No. 74).
- E. L. Safford, Jr., *Radio Control Manual* (Gernsback Library No. 91).
- Howard G. McEntee, *Radio Control Handbook* (Gernsback Library No. 93).

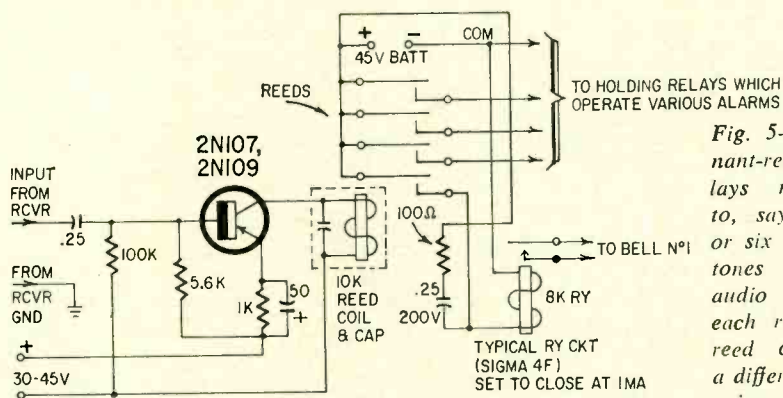

Fig. 5—Resonant-reed relays respond to, say, four or six specific tones in the audio range; each resonant reed controls a different circuit.

WHERE TO GET RESONANT-REED RELAYS

Most good-sized hobby shops carry several types. Try the model aircraft department. Two New York City hobby stores expressed their willingness to handle mail orders:

America's Hobby Center, 146 W. 22 St., New York, N. Y. 10011 has a relay with a 3,000-ohm coil, six channels, for \$12.50.

Polk's Hobbies, Model Aircraft Department, 314 5th Av., New York, N. Y. 10016, sells a 3,000-ohm relay with 10 reeds for \$11.95 plus 50 cents for postage and handling.

Although the article calls for 5,000- to 10,000-ohm coils, that's impedance, whereas the figures given above are dc resistance, which is always lower. So the relays listed here should work.

Lafayette Radio Electronics Corp., 111 Jericho Turnpike, Syosset, N. Y. 11791, sells a 5-channel relay with a 900-ohm (dc resistance) coil for \$7.95 plus postage for 8 oz. (stock no. 42 G 1908).

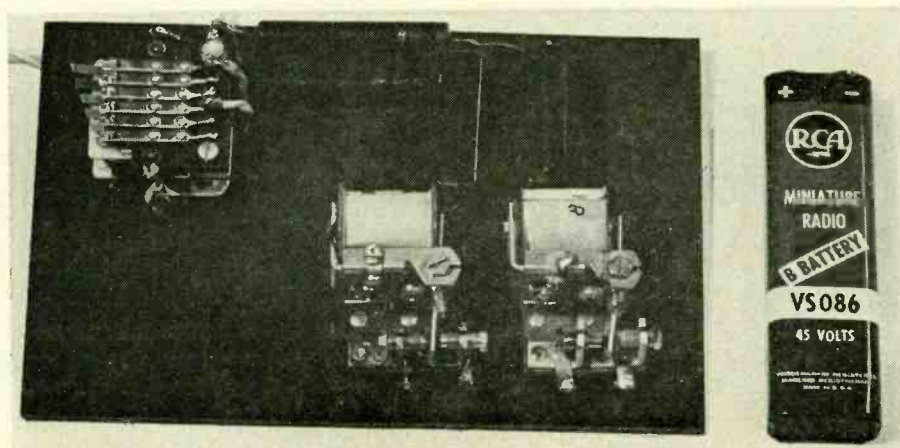
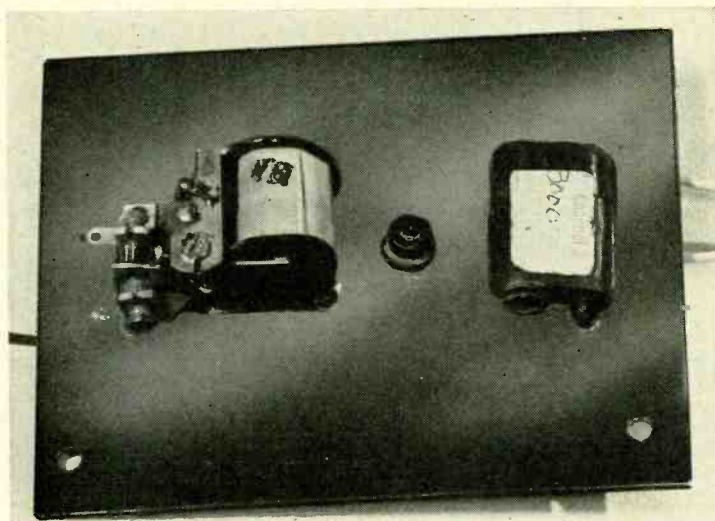

Resonant-reed selective signaling circuit. Reed relay is at left; holding relays for two channels, center and right.

MAKE YOUR OWN TCS!

Complementary transistor pairs, connected regeneratively, make a device—a transistor controlled switch—that works like an SCR. It's more useful for some applications

By WENDELL E. LAVENDER

YOU'VE PROBABLY SEEN LOTS OF ARTICLES on SCR's. Maybe you've even read a few. But—*did you know you can design and build your own SCR's*—or GCR's (germanium controlled rectifiers)? Your own SCR's can be better suited to your needs than ready-mades.

The SCR (or, more broadly, the Transistor Controlled Switch) is the solid-state equivalent of the thyatron tube. Both can switch large load currents with small input signals.

The SCR can be used as a bistable or monostable multivibrator as well as a controlled rectifier and variable circuit element.

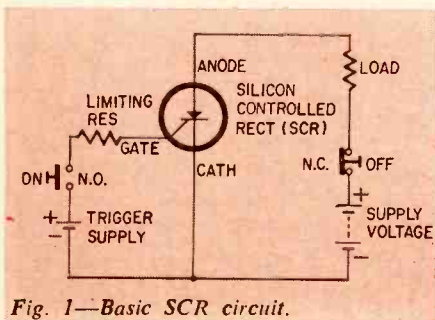

Fig. 1—Basic SCR circuit.

Fig. 1 shows the schematic of the basic SCR circuit. The positive terminal of the supply is connected through the load to the anode. The cathode and the negative terminal of the supply are connected. With no input trigger to the SCR gate, no power is switched to the load. Once the gate is triggered on by a small positive-going voltage, power to the load is turned on. The voltage drop across the SCR will be less than a volt for load currents of up to 1 amp. Some SCR's are rated much higher—up to several hundred amps. The gate control voltage is no longer needed once the SCR has been turned on.

To turn off an SCR, the anode current must be interrupted briefly. As soon as that is done, the SCR returns to a high impedance—effectively an open circuit. The SCR may be turned on and off repeatedly this way.

There is another way of making an SCR turn off: using an ac supply. As soon as the supply voltage makes the anode voltage zero or negative, the SCR turns off. However, the rectifier can be on only during the positive half-cycle, and the response time of the circuit

is limited to the frequency of the ac.

Some circuits are designed with more than one SCR, so that when one turns on, the other goes off.

The secret

An SCR can be duplicated with two transistors! One transistor must be n-p-n, the other p-n-p. Either or both may be germanium or silicon. Silicon transistors will operate at higher temperatures, but germanium transistors have a lower collector-to-emitter saturation voltage.

Fig. 2 shows two transistors connected to simulate the SCR shown in Fig. 1. The circuits in Figs. 1 and 2 work the same way. In Fig. 2 it is easier to see what happens, since more people are familiar with transistors than with SCR's.

How does the circuit of Fig. 2 turn on and hold on? Operating the ON switch supplies the turn-on trigger. As the n-p-n transistor (bottom) draws base current, its collector current rises. The collector of the n-p-n transistor is connected to the p-n-p transistor's base, and the p-n-p transistor's collector is connected back to the n-p-n's base. This cross-connection makes the transistors amplify each other's collector currents, creating a very-high-gain positive-feedback loop. Each transistor continues to amplify the other's collector current until both are saturated. Once on, both transistors remain saturated, until they are made to turn off.

The operation of the transistor controlled switch (TCS) is the same as that of the SCR. The internal makeup of the SCR is very similar to the two-transistor connection.

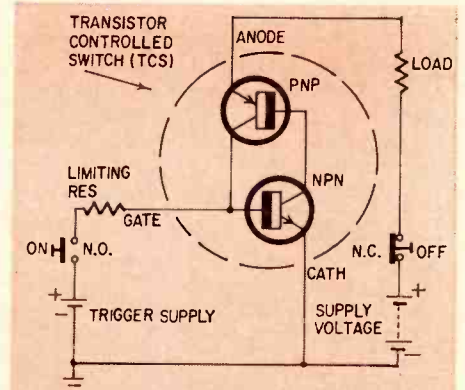

Fig. 2—Basic transistor controlled switch (TCS) circuit. It can be flipped upside down, and the gate triggering signal can be applied to either base, with correct choice of polarity.

The TCS can do some things the SCR can't do. The n-p-n and p-n-p transistors can be interchanged. Now the circuit can work with a power supply of opposite polarity. And the TCS can be turned off in more ways than the SCR.

The TCS can be connected for positive or negative power supply operation. This may be very important to the designer if all his other circuits and components are connected for a negative power supply, since SCR's are available for a positive supply. The TCS connected for a positive supply will need a positive trigger. So in some cases the choice of TCS may be determined by what type of pulse is available for triggering. It may prove useful to alternate positive and negative TCS's to simplify cascading circuits. This type of design may even allow some circuits to be left out in logic design, such as drivers or inverters.

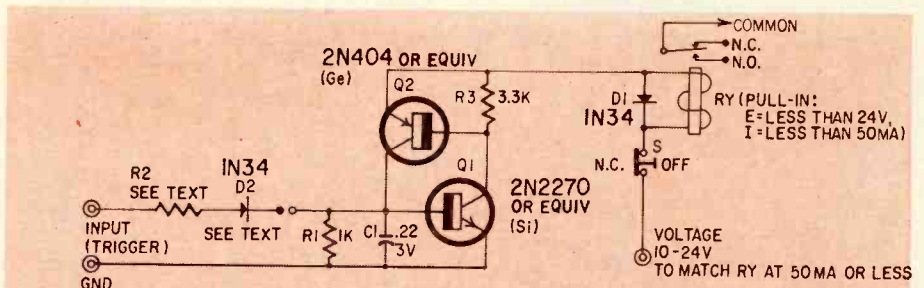
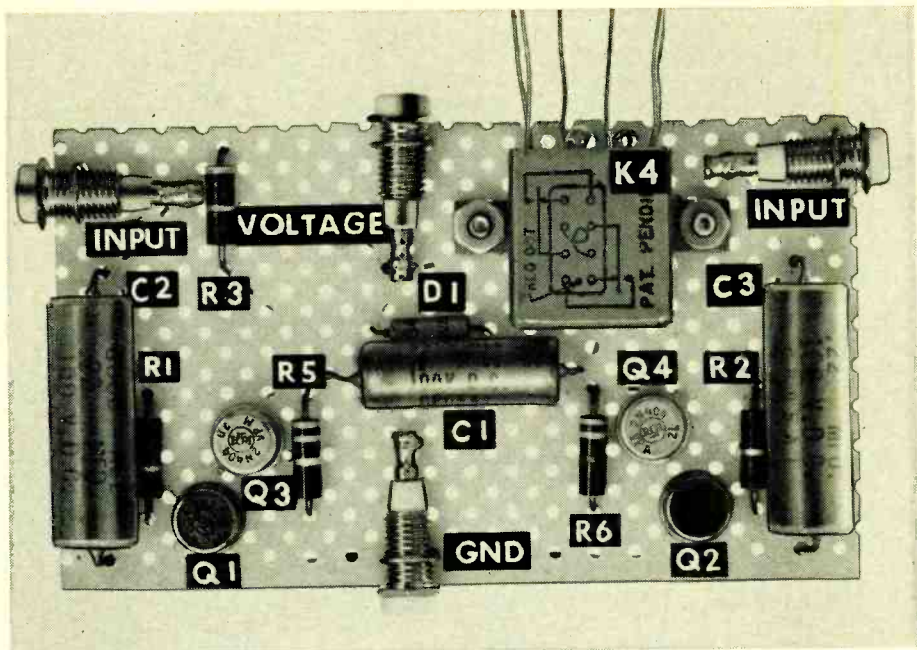

Fig. 3—A practical latching-relay circuit. D2 and R2 are optional—see text about their use.

The TCS may be turned off in other ways, different from the ways to turn off an SCR. If a negative voltage is connected to the gate of Fig. 2 when the TCS is on, it will turn the TCS off. The off-control voltage must supply enough current to overcome the base current of the n-p-n transistor being supplied by the collector of the p-n-p transistor. The base current of the n-p-n will be about half the load current.

Another way to turn off the TCS is to short the base and emitter leads of the n-p-n transistor. This is the same as shorting the gate and cathode terminals of an SCR. The shorting can be done with a switch or another transistor. Most transistors have a lower collector-emitter than base-emitter saturation voltage.

Many transistors can be used for the TCS. Large-signal ones can be used in the same way as small-signal transistors, bearing in mind that the larger transistors will have a larger leakage current and will require different



Circuit of Fig 4 built on a perforated board. Relay K4 replaces R4 in Fig. 4; diode across its coil is D1.

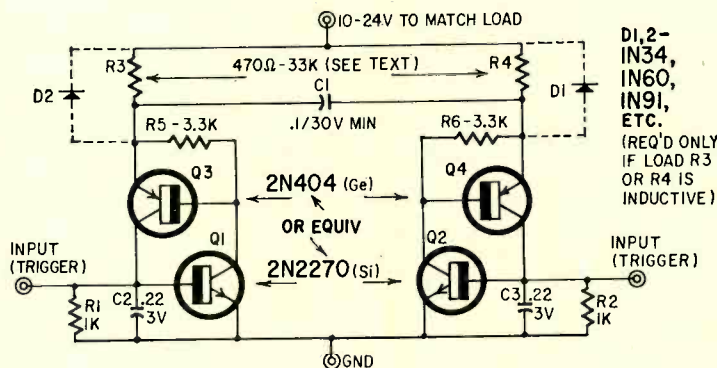

D1, D2—1N34, 1N60, 1N91, ETC. (REQ'D ONLY IF LOAD R3 OR R4 IS INDUCTIVE)

Fig. 4—TCS flip-flop. R3 and R4 can be replaced as required with relay coils. Diodes D1 and D2 are required only if R3 and R4 are inductive (like relay coils, for instance).

circuit values. Even some "bargain" n-p-n and p-n-p audio transistors may be used.

When building the TCS, observe the same precautions that you would with any transistor circuit. Be careful of overheating the transistors during soldering. Double-check the connections carefully before turning on the power. Make sure the power is off before making any changes. Voltage spikes or transients may damage the transistors.

Be sure to note that half the load current flows in the base circuit of both transistors. Most transistors have a lower base-current rating than collector-current rating. Do not exceed the rated base current of the transistor you are using if you want reliable operation. Here is a rule of thumb for estimating it, if you don't have exact figures: If it is a switching transistor, the base current will be 50% to 100% of the collector current, as long as the total transistor dissipation is not exceeded. For linear or audio transistors the base current will be 10% to 20% of the collector current.

Resistors must be added between the base and emitter leads of both transistors. This is necessary because of the leakage current, I_{ebo} , which must be shunted around the base-emitter junction by the resistor, if the transistor is to be cut off. If the resistor is too large, the TCS will not turn off. The value of the resistor is determined by the leakage current (I_{ebo}), and the base-to-emitter voltage drop needed to turn the transistor on. This base-emitter voltage is about 0.6 in silicon, and 0.2 in germanium transistors. If high-tempera-

D1, D2—1N547, 1N645 or equivalent (see table)*
 Q1—2N2270, 2N1613, 2N697 or equivalent silicon; 2N647, 2N649, 2N1302, 2N1304, 2N1306, 2N1308 or equivalent germanium
 Q2—2N721, 2N722, 2N1131, 2N1132, or equivalent silicon; 2N217, 2N404, 2N526, 2N1303, 2N1305, 2N1307, 2N1309 or equivalent germanium
 R1, R2—see table below
 Circuit shown is a p-n-p-n device. Terminals are labeled. Bracketed labels apply to an n-p-n-p device—the same circuit inverted.

If Q1 is:	Si	Ge	Si	Ge	Ge (diode)	Ge
and Q2 is:	Ge	Si	Si	Ge	Ge	Ge (diode)
R1 should be (ohms)	1,000	3,300	3,300	270	2,700	1,000
R2 should be (ohms)	3,300	1,000	3,300	270	1,000	2,700

Ge = germanium; Si = silicon
 *Diodes D1 and D2 are used when both transistors are germanium. A conducting silicon diode provides an additional 0.7-volt back bias for the emitter-base junction. If one of the diodes is not used, R1 and R2 (table, above) must be lowered in value, reducing sensitivity. When a silicon transistor is used, the emitter-base voltage is already 0.7, so the diode is not needed.

ture operation is needed, the resistors will have to have a lower value. The table gives a range of typical values for various transistors.

With most transistors it is necessary to add a capacitor between base and emitter of one of the transistors. Without a capacitor, a fast turn-on of the power supply voltage will couple through the internal capacitance of the transistor, producing a false on-trigger. An external base-emitter capacitor prevents this.

Several circuits are shown in Figs. 3, 4 and 5. Any of them will help you understand uses of the SCR. TCS's are used in the circuits shown, but SCR's would work just as well.

Fig. 3 is a latching circuit. Once the gate is triggered, it will turn on the load and hold it on until the OFF switch is operated. Diode D2 is needed if the trigger circuit is very-low-impedance and might short R1 after triggering. R2, used only when needed, limits the gate input current to 50 ma maximum. D2 and R2 should be used with any TCS circuit when needed.

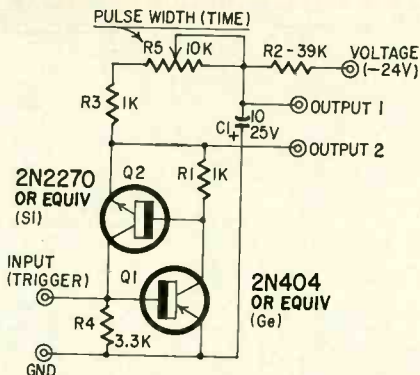

Fig. 5—TCS monostable multivibrator. Trigger pulse turns it on; circuit turns itself off after delay determined by C1, R3 and R5.

Fig. 4 is a TCS flip-flop, or bistable multivibrator. The loads R3 and R4 may be resistors, lamps or relays. The TCS will operate with load current variations between 1 and 50 ma. If a relay is used for one or both of the loads, it should be shunted with a diode as shown

to prevent damage to the transistors from inductive-kick voltage spikes.

Fig. 5 is a monostable multivibrator. C1 and R3 plus R5 set the pulse width. During on time the TCS current is supplied by C1. As C1 discharges, the TCS current decreases until it drops below the holding current. Then the TCS becomes a high impedance (off). While the TCS is off, R2 charges C1 to the supply voltage. As soon as C1 is charged, the TCS is ready to fire again. The base-emitter capacitor is not used in this circuit since the TCS turns itself off.

Figs. 3 and 4 use positive supplies, while the circuit of Fig. 5 uses a negative supply. Any of the circuits may be inverted as indicated in the table to allow either polarity to be used.

These are only a few of the applications for the TCS and the SCR. With what you know now, you're ready to design and build your own. END

REFERENCES

Transistor Manual, 7th Edition, copyright 1964, General Electric Co. SCR Manual, 3rd Edition, copyright 1964, General Electric Co.

WHAT'S YOUR EQ?

Conducted by
E. D. CLARK

Which Row?

Shown are five rows of resistors. Four of the rows contain 100-ohm resistors, and one row contains 200-ohm

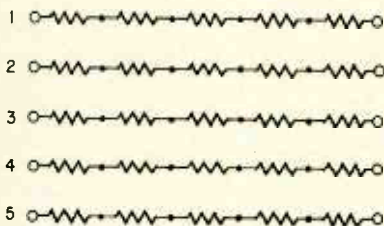

resistors. Interconnect the rows so that one measurement determines which row contains the 200-ohm resistors.—E. R. Pickren

Effective Value?

If we measure a 10-volt peak of a

Three puzzlers for the students, theoretician and practical man. Simple? Double-check your answers before you say you've solved them. If you have an interesting or unusual puzzle (with an answer) send it to us. We will pay \$10 for each one accepted. We're especially interested in service stinkers or engineering stumblers on actual electronic equipment. We get so many letters we can't answer individual ones, but we'll print the more interesting solutions—ones the original authors never thought of.

Write EQ Editor, Radio-Electronics, 154 West 14th Street, New York, N. Y. 10011.
Answers to this month's puzzles are on page 107.

sinusoidal source with a vtvm, we will read 7.07 volts rms on the scale of the meter, disregarding losses and faulty

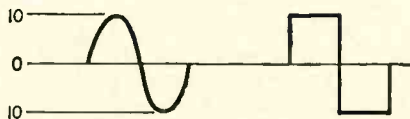

calibration. However, what will we read on the meter scale (same range) if we measure a 10-volt peak square-wave source, and would this measurement be the effective value of the square wave? —J. A. Chambers

Unbalance

I was having trouble on one range of a home-constructed Wheatstone

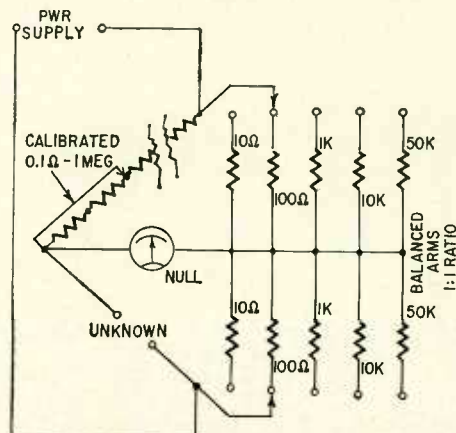

bridge. Because of their good stability, closely matched (0.1%) wirewound resistors were used for the balanced arms (1:1 ratio) while 1% metal-film type were used for the calibrated arm.

A short time after completion, readings taken using the 100-ohm balanced arms were off compared with those taken using the other-value balanced arms. These two resistors were rematched without removing (either by shunting higher value or adding to lower value). After a few days, the same trouble showed up. What's wrong?

—E. D. Clark

50 Years Ago

In Gernsback Publications
In October, 1915
Electrical Experimenter

Editorial—The Wireless Amateur
Can Electricity Transmit Thought
Waves ?

New Phonograph Has Compressed-Air Amplifier

Telemechanics or Control by Radio Waves

MEASURING Q WITH A SCOPE

MR. E. L. DESCHAMBAULT PRESENTED an interesting flyback testing method on page 59 of the July 1962 issue of RADIO-ELECTRONICS.

[In the original item, a high-amplitude pulse was tapped off the scope's blanking or horizontal sweep circuit and fed to the inductance under test through a 10-pf, 1.6-kv capacitor and an insulated binding post.

To use, connect a jumper from the added terminal to the scope's vertical input terminal. Connect the part under test between the vertical input and ground terminals. The inductor is good if the waveform looks like *a* below, defective if it looks like *b* and completely shorted if you get a line like *c*.—*Editor*]

With refinements, that scheme can be extended to other uses. The inductance under test is acting as a tuned circuit, resonated by its distributed capacitance and the stray capacitance in the testing circuit. Thus, the waveform observed is a damped oscillation whose rate of decay depends on the Q of the inductance.

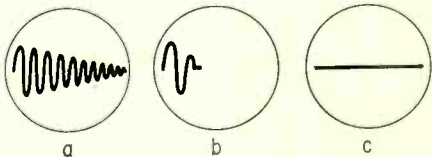

In the original setup, the inductance is shunted by the plate resistance of the triode which produces the exciting pulses. In some cases, this will lower the Q much below that of the inductance alone, and the sensitivity of the test will be reduced. This can be remedied by connecting a resistor between the inductance and the pulse-output binding post. The resistor should be large compared to the resonant impedance of the inductance. The amplitude of the oscillation will, of course, be reduced, but this will ordinarily cause no difficulty. The input impedance of the vertical amplifier also shunts the inductance, but this will have negligible effect except for extremely high-Q coils.

With these precautions, this scheme can be used to measure the Q of any tuned circuit whose resonant frequency is within the passband of the vertical amplifier. The result is gotten from the formula $Q = 4.54N$, where N is the number of cycles required for the amplitude of the oscillation to decay to half its initial value.—*Charles E. Cohn*

Use it to Cut Snow on Weak Channels



As 2-Set Coupler, Gives Each Set Min. of 7db Gain



Extends Rabbit Ear Range in Medium Signal Areas



Boosts Signals to a 4 or 6 Set Coupler

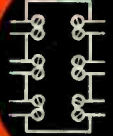

REPLACES EC-230

THIS IS THE ALL NEW WINEGARD BC-107... MOST VERSATILE BOOSTER-COUPLER IN ITS PRICE CLASS



Extra Terminals let you boost Signal to Single TV or FM Set With Minimum 12db Gain

What makes the BC-107 such a special booster-coupler? Well, for one thing, the BC-107 eliminates the 3 to 4db loss inherent in 2 set couplers. In fact, it actually gives a 7db boost to both sets connected to it. Now you can easily connect 2 sets to one antenna in fringe areas and get perfect reception on both sets—in color or black and white. An extra set of terminals lets you use the BC-107 as a booster for 1 set with a minimum of 12 db gain.

This powerful, transistorized unit also has linear frequency response across both TV and FM bands and an exact match into 300 ohms. This means No

Smear, No Ghosts, No Picture Degradation, No Interference Between Sets.

Works with TV and FM signals from 25 to 45,000 microvolts. Has one 300 ohm input, three 300 ohm outputs, no-strip terminals, 110V-AC cord, and a brand new casing of high impact polystyrene, specially designed for the neatest, simplest indoor installation possible.

Write today for complete details or ask your distributor about the BC-107 from Winegard . . . Hottest new number in the Red Hot Booster-Coupler Market.

\$18⁹⁵ list

 **Winegard Co.**

3013-G KIRKWOOD BOULEVARD • BURLINGTON, IOWA

Circle 29 on reader's service card

SOMEONE SHOULD DEVELOP AN EASY WAY TO LEARN ELECTRONICS AT HOME

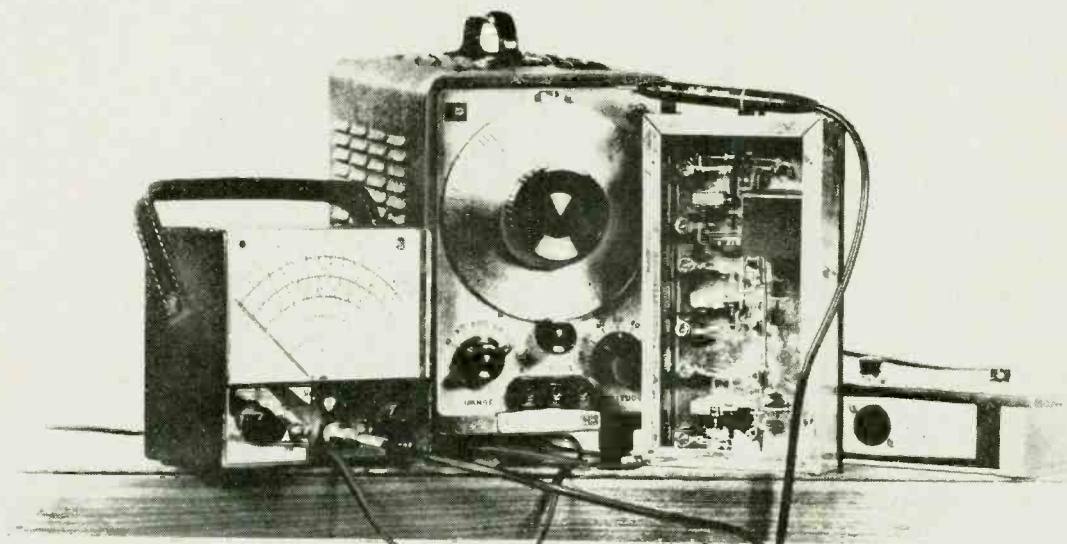

RCA INSTITUTES DID!

Here is a whole new approach to learning electronics at home! RCA Institutes, one of the nations' largest schools devoted to electronics, has developed a faster, easier way for you to gain the skills and the knowledge you need for the career of your choice. Here for the first time, is a student-proved, scientifically designed way to learn. If you have had any doubts in the past about home training in electronics —if you have hesitated because you thought you might not be able to keep up—or that electronics was too complicated to learn—here is your answer! Read how RCA Institutes has revolutionized its entire home training ideas!

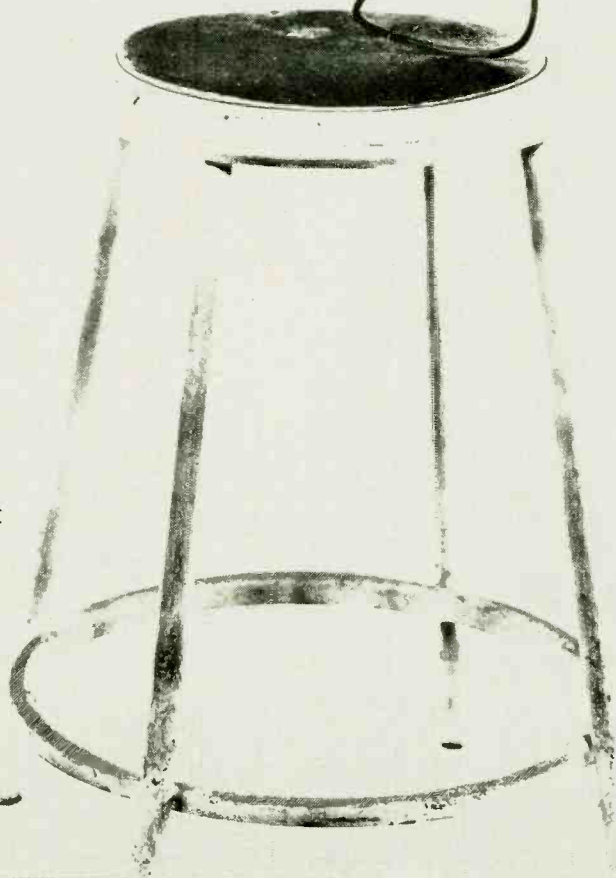

NEW CAREER PROGRAMS BEGIN WITH "AUTOTEXT" INSTRUCTION METHOD!

Start to learn the field of your choice immediately!

No previous training or experience in electronics needed!

With this new revolutionized method of home training you pick the career of your choice—and RCA Institutes trains you for it. RCA's Career Programs assure you that everything you learn will help you go directly to the field that you have chosen! No wasted time learning things you'll never use on the job! The Career Program you choose is especially designed to get you into that career in the fastest, easiest possible way!

And each Career Program starts with the amazing "AUTOTEXT" Programmed Instruction Method—the new, faster way to learn that's almost automatic! "AUTOTEXT" helps even those who have had trouble with conventional home training methods in the past. This is the "Space Age" way to learn everything you need to know with the least amount of time and effort.

CHOOSE A CAREER PROGRAM NOW

Your next stop may be the job of your choice. Each one of these RCA Institutes Career Programs is a complete unit. It contains the know-how you need to step into a profitable career. Here are the names of the programs and the kinds of jobs they train you for. Which one is for you?

Television Servicing. Prepares you for a career as a TV Technician/Serviceman; Master Antenna Systems Technician; TV Laboratory Technician; Educational TV Technician.

FCC License Preparation. For those who want to become TV Station Engineers, Communications Laboratory Technicians, or Field Engineers.

Automation Electronics. Gets you ready to be an Automation Electronics Technician; Manufacturer's Representative; Industrial Electronics Technician.

Automatic Controls. Prepares you to be an Automatic Controls Electronics Technician; Industrial Laboratory Technician; Maintenance Technician; Field Engineer.

Digital Techniques. For a career as a Digital Techniques Electronics Technician; Industrial Electronics Technician; Industrial Laboratory Technician.

Telecommunications. For a job as TV Station Engineer, Mobile Communications Technician, Marine Radio Technician.

Industrial Electronics. For jobs as Industrial Electronics Technicians; Field Engineers; Maintenance Technicians; Industrial Laboratory Technicians.

Nuclear Instrumentation. For those who want careers as Nuclear Instrumentation Electronics Technicians; Industrial Laboratory Technicians; Industrial Electronics Technicians.

Solid State Electronics. Become a specialist in the Semiconductor Field.

Electronics Drafting. Junior Draftsman, Junior Technical Illustrator; Parts Inspector; Design Draftsman Trainee Chartist.

SEPARATE COURSES

In addition, in order to meet specific needs, RCA Institutes offers a wide variety of separate courses which may be taken independently of the Career Programs, on all subjects from Electronics Fundamentals to Computer Programming. Complete information will be sent with your other materials.

LIBERAL TUITION PLAN

RCA offers you a unique Liberal Tuition Plan—your most economical way to learn. You pay for lessons only as you order them. No long term contracts. If you wish to stop your training for any reason, you may do so and not owe one cent until you resume the course.

VALUABLE EQUIPMENT

You receive valuable equipment to keep and use on the job—and you never have to take apart one piece to build another. **New—Programmed Electronics Breadboard.** You now will receive a scientifically programmed electronic bread-

board with your study material. This breadboard provides limitless experimentation with basic electrical and electronic circuits involving vacuum tubes and transistors and includes the construction of a working signal generator and superheterodyne AM Receiver.

Bonus From RCA—Multimeter and Oscilloscope Kits. At no additional cost, you will receive with every RCA Institutes Career Program the instruments and kit material you need to build a multimeter and oscilloscope. The inclusion of both these kits is an RCA extra.

CLASSROOM TRAINING ALSO AVAILABLE

RCA Institutes maintains one of the largest schools of its kind in New York City where classroom and laboratory training is available in day or evening sessions. You may be admitted without any previous technical training; preparatory courses are available if you haven't completed high school. Coeducational classes start four times a year.

FREE PLACEMENT SERVICE

In recent years, 9 out of 10 Resident School students who used the Free Placement Service had their jobs waiting for them when they graduated. And many of these jobs were with top companies in the field—such as IBM, Bell Telephone Labs, General Electric, RCA, and radio and TV stations and other communications systems throughout the world.

SEND ATTACHED POSTAGE PAID CARD FOR COMPLETE INFORMATION, NO OBLIGATION. NO SALESMAN WILL CALL. FREE BOOK INCLUDED. CHECK HOME STUDY OR CLASSROOM TRAINING.

RCA INSTITUTES, Inc., Dept. RE-05

A Service of Radio Corporation of America
350 West 4th St., New York, N.Y. 10014



The Most Trusted Name In Electronics

Circle 30 on reader's service card

PRIVATE HEADSET HI-FI WITH SHURE SOLO-PHONE

Circle 26 on reader's service card

CONAR ELECTRONIC KITS

built in hours!



Your copy
is waiting...

The do-it-yourselfer's newest catalog

Here's your new catalog of quality electronic kits and assembled equipment . . . your shopping guide for TV set kits, transistor radios, voltmeters, scopes, tube testers, ham gear, PA systems, and a host of other carefully engineered products. Every item in the Conar catalog is backed by a no-loopholes, money-back guarantee. It's not the biggest catalog, but once you shop its pages you'll agree it's among the best. For years of pleasurable performance, for fun and pride in assembly, mail the coupon. Discover why Conar, a division of National Radio Institute, is just about the fastest growing name in the kit and equipment business.

CONAR

MAIL NOW!

CONAR

KC 5C

3939 Wisconsin Avenue, Washington, D.C. 20016
Please send me your new catalog.

Name _____

Address _____

City _____

State _____

Z-Code _____

PUTTING A HEADPHONE JACK ON YOUR amplifier is a fine idea, except that you are still up against something like using the 200-horse motor of your car to push your lawnmower around. In tube amplifiers especially, outputs are usually loaded with the correct impedance and the phones connected through comparatively large resistances, to protect them from overload and improve the signal-to-noise ratio. So the amplifier—probably capable of 20 or 30 watts—is producing 2 or 3 watts and the phones are getting maybe 2 or 3 milliwatts, which is about as near a complete waste as you'll find anywhere.

So hats off to the Shure SA-1 *Solo-Phone*, a complete stereo amplifier with preamp designed exclusively for use with headphones. Probably the simplest stereo amplifier around, it has only a friction-coupled dual volume control, an input-selector slide switch, an on-off switch and two jacks for headsets (which makes me wonder: How come *Solo-Phone*?). And a pilot light.

The power output of the unit is given on the specification sheet in millivolts. Clipping level is 400 mv at 1 kc into an 8-ohm load. Which is how much power? 20 milliwatts! But don't go away. Most high-quality headphones perform nicely with less than a milliwatt applied to them. Usually 5 milliwatts is uncomfortable, and 10 will make you want very much to take those things off your head.

The SA-1 will put out plenty of clean sound, even into the least efficient stereo headset on the market. With an amplifier that is good to begin with, and, on top of that, all the nuisances of room acoustics, damping, standing waves and

echoes eliminated, the sound is about as pure as possible, except perhaps by direct electrical stimulation of the brain. Some people think of this as sterile, like eating unripened cheese, but those who already enjoy listening via headset will find the Solo-Phone the equal of any higher-powered amplifier.

The circuit is a fairly straightforward complementary-symmetry design, with one p-n-p and one n-p-n transistor in the push-pull output stage of each channel. This is the simplest sort of push-pull transistor circuit. The only reason why it hasn't been used much for higher-power work is that it is difficult to find a matched pair of complementary power transistors at a reasonable price.

The circuit is unusual in two ways, though. First, the two stages before the output stage have a feedback loop around them that tilts the frequency response to the RIAA playback curve, making the whole amplifier its own equalized preamp. Second, since there is no separate high-level "flat" input channel for a tuner, the tuner input's response is suitably attenuated and skewed so that the overall response is flat again. Sounds cumbersome in print, but this is really the simplest, most economical way to do the job. The tuner-channel response is specified at the 100- and 10,000-cycle points as within 2 db of the 1,000-cycle gain.

The full beauty of this little amplifier comes to light only after a little consideration. If your amplifier has a headphone jack, you may be inclined to ignore the SA-1; but ponder this: For about \$100, you can assemble a bedroom music system, completely separate

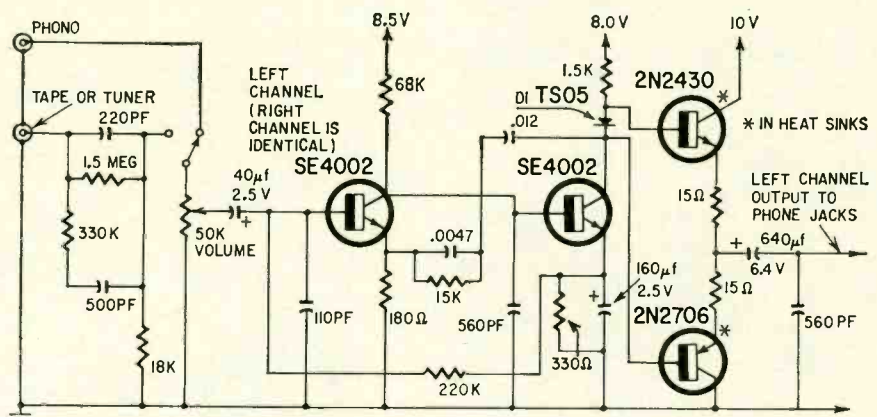

Schematic of one channel of the Shure SA-1 Solo-Phone stereo headset amplifier.

Circle 31 on reader's service card

from your main system, that would give you comfortable, convenient nighttime listening, without the bother of padding out to the living room to change records. And with headphones and 20 mw per channel, there's no chance of disturbing anyone. The amplifier generates no noticeable heat and consumes about as much power as an electric clock, so if you fall asleep and leave it on all night, no harm done.

Other uses: for auditioning records in stores and radio stations; listening rooms for libraries or music-appreciation courses in schools and colleges; private record-playing and FM-listening in hospitals and nursing homes; entertainment and training for the hard-of-hearing. It can be used also to monitor tape recordings while recording, without disturbing the recording circuit.

One thing might have been included: a mono/stereo switch. When you play monaural records through a stereo system, quite a lot of rumble and record surface noise comes along with the music—the most annoying noise being the occasional random “tick” in one channel, followed by another single “tick” in the other channel. Most of the noise disappears when the two channels are tied together. An spst switch from the high side of one volume control to the high side of the other would do.

Shure has thoughtfully included two headphone jacks. Privacy and companionship. A switched ac outlet on the back of the amplifier lets an FM tuner be switched on and off with the amplifier.

Experimenters might want to consider converting the amplifier to battery operation, since it is so small and its current drain is so low. That would increase its versatility considerably.

Except for the power transformer, panel-mounted components and the equalization circuitry, the amplifier is built on a single printed-circuit board. The simplicity and the open layout should make the SA-1 very easy to service, if it should ever need it. But the quality of the components and the small amount of heat generated should assure a very long life for the Solo-Phone.

MANUFACTURER'S SPECIFICATIONS

Frequency Response: phono input follows RIAA curve within 2 db; tuner (tape) input gain is within 2 db of 1-kc gain at 100 cycles and 10 kc

Input impedance: phono—47,000 ohms; tuner (tape)—250,000 ohms

Range of load: 4 ohms or higher

Channel separation: 40 db minimum from 50 to 20,000 cycles

Total harmonic distortion: less than 1%, both channels driven simultaneously into 8-ohm resistive loads at 100 mv

Clipping level: 400 mv across 8 ohms, at 1 kc

Operating power: 117 volts $\pm 10\%$, 50–60 cycles, 5 watts

Dimensions: 10¼ x 3½ x 3⅞ inches

Weight: 2½ lb

Price: \$45

EQUIPMENT REPORT

The KSC Speaker Balancing Record

Circle 27 on reader's service card

QUITE A FEW TEST RECORDS FOR THE audiophile have popped out of the stampers, especially since stereo came in. Here is a new kind: one that helps you adjust your *speaker* controls.

An ingenious record, it requires no instruments of any kind, and works reasonably well. The record is a 7-inch 45-rpm disc with a small center hole. The first band consists of a reference tone—100 cycles. That is followed by 100 cycles and 1,500 cycles sounded alternately, each for about 1 second. Then 1,500 and 7,000 cycles are sounded alternately, 1 second each, for about 15 seconds. The purpose of these tones is to allow you to set the brilliance or presence controls on your speakers for equal *loudness* on each tone. Note that we're not considering watts or db—this is subjective loudness, to *you*. Band 1 closes with the three tones—100, 1,500 and 7,000 cycles—repeated in that order a few times.

Band 2 uses the same approach, but this time with *pink noise* instead of pure tones. (Pink noise, loosely, is sound centered around a specific frequency. It is—in the mid-range, at least—a rushing noise, like interstation hiss in an FM tuner, but with a fairly definite pitch.) The purpose of the pink noise is to reduce errors caused by room resonances—the ear tends to average the loudness of the sound over the range of frequencies in the pink noise. Again, the user is instructed to adjust for equal loudness.

The third band contains a pink-noise “sampling” of the audio range from top to bottom and back to the top again. The listener is alerted to listen for any peaks or dips in the sound level. Dropouts or overprominent tones indicate undesirable resonances in the speaker, the room or the cartridge.

The fourth and final band is just a piano scale—all the way up from the lowest note to the highest and back down again, carefully recorded for uniform level. The instructions state that the piano should sound real and live, with no tinny highs or boomy bass.

With this record, you can set up a speaker or verify its performance subjectively in about 5 minutes. (Each speaker in a stereo system must be treated separately.) The instructions caution that results can be misleading in a speaker one of whose crossover frequencies coincides with one of the test frequencies.

If you've suspected something slightly off-color in your system, a run with this record will help you pin it down.—Peter E. Sutheim
Price: \$1.25



NEW
WEN
MODEL 222
HOT ROD
GUN
SOLDERING

The perfect answer to all Radio, TV and electronic soldering jobs.

222, with Wen's exclusive ATR (Automatic Thermal Regulation), is a power packed, lightweight precision instrument that gives you more than just dual heat. It gives you an effective and efficient range of heat up to 200 watts. The Wen Hot Rod Soldering Gun can deliver the heat-power found in a 200-watt soldering device on a current draw of only 110 watts surge and 55 watts working. Feature for feature, there's not a better soldering gun to be found anywhere. Check 'em off.

- Exclusive ATR (Automatic Thermal Regulation) permits heat-power to be automatically adjusted to the correct level for the job being done.
- Tip automatically adjusts heat-power up to 200 watts.
- New CS 1200 heat element in the tip puts heat-power on the work.
- Economy performance—more heat-power, less current draw.
- Lighter weight, more compact—beautifully balanced.
- **ONLY \$7.95**

Model 222 K-5 Kit, with rugged custom fitted case, contains flat iron and plastic cutting attachments which seal plastic bags, remove wood dents and perform dozens of accessory jobs. Kit also contains fine soldering tip for delicate soldering jobs. Only \$11.95.

WEN PRODUCTS, INC.
5810 Northwest Highway
Chicago, Illinois 60631

Circle 32 on reader's service card

Lectrotech T-100 Horizontal Deflection Circuit Meter

For manufacturer's literature, circle No. 28 on Reader's Service Card

THIS CLEVER AND USEFUL LITTLE DEVICE might have been more appropriately named a "Horizontal Frequency Sniffer," but no matter—it should find its way into a lot of shops and tube caddies. No one will claim that it represents the ultimate in horizontal-circuit troubleshooting, but no one will deny that it provides real shortcuts in speedy pinpointing of a defective stage.

the front panel besides the edgewise GOOD-BAD meter is a spring-return ON-OFF switch that makes sure you don't accidentally leave the meter on and run down the battery.

The Lectrotech model T-100 uses no test leads or jacks. The only thing on Inside the box, only a little bigger each way than a pack of cigarettes, is a pickup coil tuned to 15,750 cycles and a two-transistor amplifier that builds up

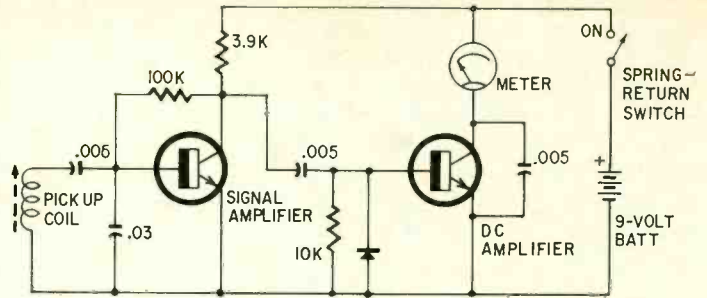

the radiation emitted by the TV set at the horizontal frequency.

Using this "horizontal scanning field-strength meter" is easy. Let's suppose that there is no raster on a particular TV set. The first thing we want to know is whether the horizontal circuit is working.

Hold the T-100 next to the face of the picture tube. If there is high voltage, the T-100 meter will read in the good part of the scale. If the meter doesn't read, move around to the back of the TV set and start sniffing around the horizontal amplifier tube. The meter will read GOOD if the amplifier circuit is working OK. In fact, you may have to back up a little to keep the meter from going off scale. Finally, if there is little or no reading at the horizontal amplifier, move over to the horizontal oscillator circuit. If the oscillator is working and is at the right frequency, the T-100 meter will deflect when you get close to the oscillator coil.

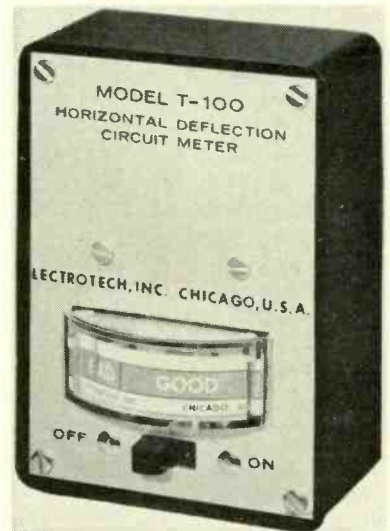

I tried the unit on several sets. After getting the feel of the instrument I could just about localize a horizontal problem to a specific spot.

I would rate the T-100 as one of those why-didn't-I-think-of-it-myself instruments that should catch the fancy of a good many TV technicians like myself who are always looking for quicker ways to diagnose horizontal-circuit troubles. The only problem is that we may not forgive ourselves for not thinking of it first.—Wayne Lemons

Price: \$19.50.

FREE NEW 1966 GIANT CATALOG

TUBES PARTS ETC. AT LOWEST PRICES

100'S OF BARGAINS NOT IN ANY OTHER CATALOG

100's of new items listed for first time

SAVE UP TO 50% ON CHOICE KITS

Satisfaction GUARANTEED or your money back!

SAVE ON CAMERAS FILM & PHOTO EQUIPMENT

EVERYTHING IN HI-FI AND STEREO

TOP VALUES IN POWER & HAND TOOLS

NO MONEY DOWN PLUS REVOLVING CHARGE ACCOUNT

100's of pages packed with savings

BURSTEIN-APPLEBEE CO. Dept. RE, 1012-14 McGee St., Kansas City, Mo. 64106

FOR 38 YEARS THE OUTSTANDING MONEY SAVING BUYING GUIDE FOR:

- Stereo & Hi-Fi Systems and Components
- Tape Recorders
- Electronic Parts, Tubes, Books
- Phonos & Records
- Ham Gear
- Test Instruments and Kits
- Cameras and Film
- Public Address
- Citizens Band
- Transistor & FM-AM Radios.

RUSH COUPON TODAY

NAME _____

ADDRESS _____

CITY _____ STATE _____

Please be sure to show your Zip No. _____

Rush me the FREE 1966 B-A Catalog.

Circle 33 on reader's service card

Use this check list before you install a home TV distribution system

	COAXIAL VHF	TWINLEAD* VHF	COAXIAL UHF/VHF	TWINLEAD* UHF/VHF AND UHF ONLY
Channels received	2-13	2-13	2-83	2-83 (14-83 for UHF only)
Color reception when properly installed	Excellent	Excellent	Excellent	Excellent
Cable loss: @ channel 13 for VHF only @ channel 83 for UHF/VHF	4 db (foam filled) 6 db (solid)	1.8 db/100 ft. @ Channel 13	9 db (foam filled) 13 db (solid)	5.6 db/100 ft. @ Channel 83
Loss increase when wet	Nil	Negligible	Nil	Negligible
Reception when run near or through small metal areas	Excellent	Excellent when properly installed	Excellent	Excellent when properly installed
Reception when run near or through considerable amounts of metal	Excellent	Not recommended	Excellent	Not recommended
Ease of installation	More difficult	Easy	More difficult	Easy
Extra parts required	Connectors, matching transformers	None	Connectors, matching transformers	None
Performance in strong-signal areas	Excellent	Excellent—fair**	Excellent	Excellent—fair**
Performance in weak-signal areas	Excellent	Excellent	Excellent	Excellent
Cable pickup of interference (ignition, appliances, etc.)	None***	None—slight**	None***	None—slight**

*A high quality, low-loss foam encapsulated cable type **Depends upon local conditions ***Poorly designed accessories will pickup interference.

Once you know the facts—there is one best choice for your home system—Blonder-Tongue. Whether you prefer 300 ohm or a 75 ohm coax system, Blonder-Tongue has the products you'll need. There is only one way you can protect your home TV system against obsolescence when new UHF stations come on the air—that's with a Blonder-Tongue all-channel UHF/VHF system.

Blonder-Tongue products designed for all-channel home systems include: All-channel signal amplifiers (V/U-All-2 indoor and U/Vamp-2 mast mounted); all-channel couplers (A-102-U/V two-set and A-104-UV four-set). Rounding out the all-channel concept are UHF/VHF matching transformers (Cablematch U/V set mounted; MT-283 mast-mounted) and the TF-331-U/V flush-mounted feed-thru.

Take your pick. Blonder-Tongue makes them all—and all are "Color Approved". Buy the line with 15 years of quality leadership. Write for free booklet "How to Plan a Color-Approved Home TV System".

BLONDER-TONGUE

9 Alling Street, Newark, New Jersey 07102

home TV accessories • closed circuit TV •
community TV • UHF converters • master TV

Circle 34 on reader's service card

Otto Werk
sent in
this
coupon

UNIVERSITY SOUND
Desk K-59, P. O. Box 1056 Oklahoma City, Okla.

Send me the UNIVERSITY Hi-Fi Guide
 Send me the MUSTANG STORY

Name _____
Address _____
City _____ State _____ Zip Code _____

Look what he got!

Lots of help . . . right from the horse's mouth, 'cause now University's got a Mustang! Plus a corral full of other speakers. University speaker guides showed him how to choose a speaker system, how to build a custom system with separate speakers—and much more! Send for these guides right away. You'll be an expert too. Just like a smart Dane named Otto.



Circle 35 on reader's service card

NEW FROM ENGLAND



Princess

AUTOMATIC/MANUAL TURNTABLE SYSTEMS

will outperform, outplay
and outlast most chang-
ers on the market that
sell for twice the price!



Model #RCD-4
\$47.50

Write
For
Details



Model #RC-2
\$37.50



RFS INDUSTRIES, INC. 102 HARBOR ROAD, PORT WASHINGTON, NEW YORK 11050

Tel: (516) 883-7575

Circle 36 on reader's service card

NEW SEMI- CONDUCTORS AND TUBES

NICHROME THIN-FILM TRANSISTOR

A new transistor that combines thin-film and planar epitaxial manufacturing techniques to handle up to 30 watts at several megacycles has been announced by Fairchild Semiconductor.

The FT7207 is packaged in a 7/16-inch isolated hexagonal case, which makes it quite small for that level of power. Its gain-bandwidth product is 70 mc, minimum.

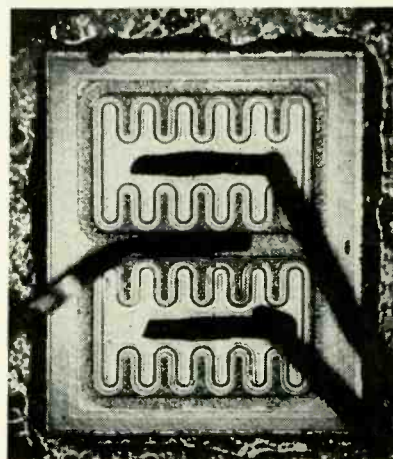

The new transistor uses thin-film resistive emitter connections made of nichrome—the well known "toaster wire" of nickel, chromium and iron—to equalize the current flow through the several sections of the transistor's structure (see the photo). This is said to prevent thermal runaway, and therefore enables the transistor to function at higher voltages, currents and temperatures than previous similar designs.

SCREEN SIZES, 23- and 25-IN. COLOR TUBES

In our New Semiconductor and Tubes section of the January 1965 issue, we published screen dimensions of the new 23- and 25-inch color picture tubes.

We have received information pointing out that different ground rules were used for the data for these types and that the comparison was misleading.

The Joint Electron Device Engineering Council of the EIA has recommended a procedure for registering screen dimensions for color shadow-mask picture tubes. This procedure calculates *minimum* screen dimensions

FINCO

COLOR-VE-LOG ANTENNAS

FOR UHF, VHF, FM RECEPTION

ALL-BAND UHF-VHF-FM ANTENNA

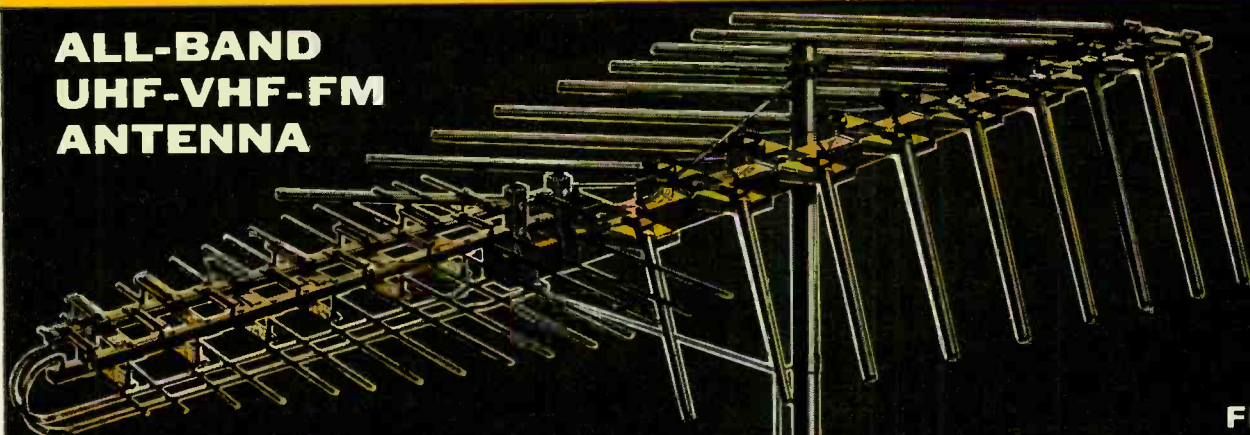

FINCO
Model UVF-24
\$59.95 list

The one antenna that does the work of 3! Gives startlingly clear black and white pictures and beautiful color on both UHF and VHF television channels — plus the finest in stereophonic and monophonic sound reproduction.

FINCO Model UVF-18 — \$42.50 list
FINCO Model UVF-16 — \$30.50 list
FINCO Model UVF-10 — \$18.50 list

SWEPT-ELEMENT VHF-FM ANTENNA

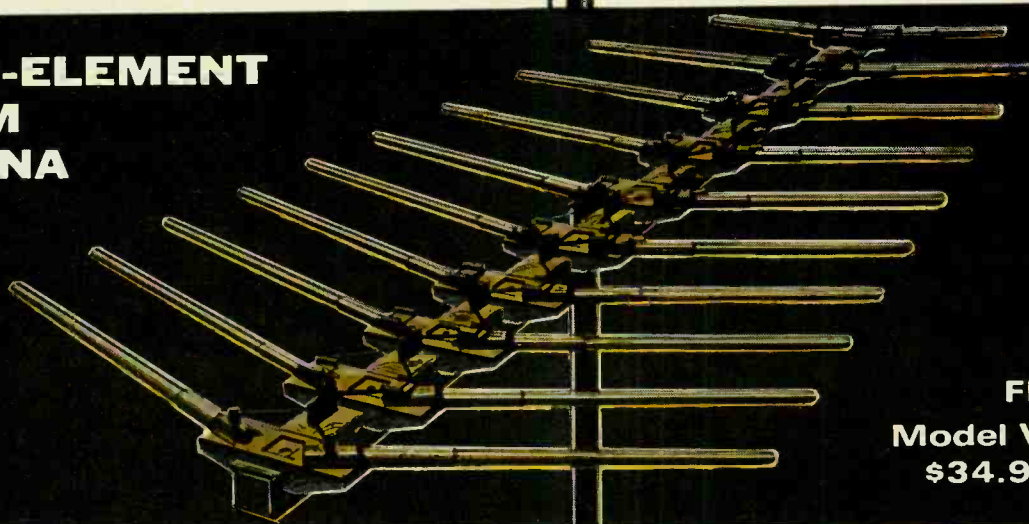

FINCO
Model VL-10
\$34.95 list

FINCO's Color-Ve-Log challenges all competition! Its swept-element design assures the finest in brilliant color and sharply defined black and white television reception — as well as superb FM monaural and stereo quality.

FINCO Model VL-18 — \$54.50 list
FINCO Model VL-15 — \$46.95 list
FINCO Model VL-7 — \$23.95 list
FINCO Model VL-5 — \$16.95 list

Featuring FINCO's exclusive Gold Corodizing
FINCO COLOR-VE-LOG

Prices and specifications subject to change without notice

THE FINNEY COMPANY • 34 W. Interstate Street • Bedford, Ohio

Write for beautiful color brochures Number 20-322, and 20-307, Dept. RE

Olson



Fill in coupon for a **FREE** One Year Subscription to **OLSON ELECTRONICS'** Fantastic Value Packed Catalog — Unheard of **LOW, LOW PRICES** on Brand Name Speakers, Changers, Tubes, Tools, Stereo Amps, Tuners, CB, Hi-Fi's, and thousands of other Electronic Values. Credit plan available.

NAME _____
 ADDRESS _____
 CITY _____ ZONE _____ STATE _____

If you have a friend interested in electronics send his name and address for a **FREE** subscription also.

OLSON ELECTRONICS, INC.

409 S. Forge Street Akron, Ohio 44308

Circle 38 on reader's service card

Normal Size	Typical Tube Type	Area (Sq. In.)	Diagonal (In.)	Height (In.)	Width (In.)
23 in.	23EGP22	268	21.990	14.770	18.912
25 in.	25AP22A	295	22.995	15.575	19.875

from the glass vendors' registered bulb design print. The actual screen dimensions would normally be larger than the registered values. These recommended "minimum" screen sizes were used in the registered specifications of the 25-inch rectangular color tube. They were not used in the registration of the 23-inch rectangular color tube.

To compare one tube size with another properly, minimum screen dimensions should be calculated using the recommended procedure.

The calculated screen measurements, shown on the table above, use the abovementioned industry recommended procedure, and are comparable.

The EIA recommendation is somewhat complex and there is some room, apparently, for interpretation. In releases on the 1966 line of Motorola TV's, the 23EGP22, for example, is stated to have a viewing area of 274 instead of 268 inches. Calculated by the same method, we were informed, the

25AP22A would have a 300-square-inch viewing area.

COLOR PICTURE IS ROSY HUED

An "explosive increase in consumer demand" is the reason for a mighty expansion of color-CRT production facilities by RCA and Sylvania.

The quoted words are those of W. Walter Watts, RCA group executive vp, who announced RCA's \$50-million expansion at a recent press conference.

Almost simultaneously, Sylvania Electric Products announced that it would double its color-CRT output in 1965, in an expansion program begun late in 1964 and completed in July.

The RCA \$50-million budget is divided between color-picture-tube production (\$36.4 million) and color set production (\$13.3 million) at several manufacturing operations around the country.

Sylvania did not release dollar figures with its announcement, but pointed out that increased production would be accompanied by increased research into color TV.

RCA TO MAKE 15-IN. COLOR TUBE

RCA has officially announced plans to manufacture the industry's first 15-inch rectangular color picture tube, intended for use in lightweight portables.

The new tube is not expected to be in production until 1966, but no more exact date was given. It has 90° deflection and uses the standard three-gun, shadow-mask principle.

Technical details will be announced in this column as soon as they become available.

REPLACEMENT-TRANSISTOR LINE

A group of five transistors, packaged singly on cardboard-and-plastic blister packs, is claimed to be able to replace 2,977 transistor types, according to Workman Electronic Products, Inc., maker of the new line.

The group consists of the AA1, a p-n-p all-purpose oscillator, mixer, converter, i.f. or audio amplifier transistor; the AA2, similar but n-p-n; the AA3, a high-frequency oscillator, mixer or converter (as in FM sets, for instance); the AA4, an all-purpose "diamond-base" (TO-3) p-n-p germanium power transistor, and the AA5, a circular-base stud-mount (TO-36) power transistor.

An 11-by-17-inch wall chart is available, which lists the 2,977 types and the Workman equivalent for each.

LATEST and GREATEST!

NEW *Brach* UHF/VHF TV ANTENNAS FOR Black/White & Color



- **Ultimate in Design!**
- **Unequaled in Performance!**
- **Outstanding in Value!**

6651 Gold Finish
 6652 Chrome Finish

SEND FOR our latest catalog with our complete line of antennas

BRACH MFG. CORP. DIV. of General Bronze Corp.

899 Main Street, Sayreville, N.J. 08872

Circle 39 on reader's service card

with valuable SMB certificates

100
certificates

A—1615 RADIANT IMPERIAL SCREENMASTER PROJECTION SCREEN. Finest screen available for color projection. New Lenticular "Uniglow" fabric controls light reflection for clear, sharper, more brilliant pictures. Size: 40" x 40". B—3433 SPORT COAT BY STANLEY BLACKER. The slim-trim look, tailored with three buttons and center vent. 100% wool herringbone in medium grey or charcoal brown. Sizes: regular, 36 to 46; short, 36 to 44; long, 38 to 46. Specify size, length and color. C—5073 ALLIGATOR GOLD LABEL GABARDINE TOPCOAT. All virgin wool worsted. Water-repellent. Single-breasted, raglan sleeves, fly front. Color: Clay. Sizes: 38, 40, 42, 44 or 46 in regular or long; sizes: 38 to 44 short. Please specify size and length. D—583 THREE SUITER. 26" BY SAMSONITE. Molded of jet-age magnesium, covered with wear-resistant vinyl. Recessed lock. Available in oxford grey, deep olive. Or (579) matching Ladies' Pullman Case in blue, white, willow green or oxford grey. Specify color. E—1755 BILLY CASPER SHOTMAKER CLUBS BY WILSON. Woods. Set of 3. Right. Leather reminder grips, chrome-plated flex-action shafts. Woods have Strata-Bloc cherry finish heads treated to seal out moisture. F—5827 WALNUT SNACK TABLES BY VERMILLION. Set of 4 beautifully grained solid walnut tables with matching storage rack. Mar- and stain-resistant finished tops. Sturdily constructed tables that can be pulled over your lap and are perfect for TV snacks or the children's homework. Size: 15" x 19" top; 25" high. G—3341 FARBERWARE "OPEN HEARTH" ELECTRIC BROILER/ROTISSERIE. Stainless steel body. Heavy-duty motor turns meat slowly for even self-basting. No splatter, no smoke. Gives delicious outdoor flavors indoors. H—4146 ELEKTRIKBROOM BY REGINA. With rug-pile dial nozzle. Easy to handle, no dust bags to buy. Requires no attachments for use on carpets, floors, steps, draperies, etc. Only 8 1/4 lbs. I—146 WEBSTER-WILCOX LAZY SUSAN. Heavily silverplated revolving tray, fitted with crystal partitions. Elegant server for party snacks, relishes, appetizers. Use as a cake server without crystal dividers. 15" diameter. J—4077 CUSTOM THREE-SPEED PUSH-BUTTON OSTERIZER. Clearly marked, Hi., Med., Lo., and Off. 5-cup heat-resistant glass container with pouring spout and graduated for measuring. Chrome base. Removable processing unit will fit all standard mason jars. Recipe book included. K—6647 PENDANT. The 14K white-gold heart-shape pendant is set with a fine white brilliant 58-facet diamond weighing 10/100 carat. L—228 JASON DELUXE 7 X 35 BINOCULARS. Fully coated optics, center focus. Light-weight and compact. Field of view, 365 ft. at 1000 yds. Height: 4". Includes case.



Account No. 98287-6

This Certificate is redeemable for awards illustrated in the
SYLVANIA MEANS BUSINESS Award Brochure.

Not valid after June 30, 1966.

DEALER CERTIFICATE DEALER CERTIFICATE

NOT REDEEMABLE

SMB coupons add up fast when you specify Sylvania quality picture tubes and receiving tubes. Start saving today for exciting free prizes for yourself, the family, the home.



20
certificates

A—ET 6103 JUNIOR TUBE CADDY. Wear-resistant Armorclad covering. Holds 150 tubes. 16½" long, 11½" high, 8½" wide. B—4166 CORNING WARE PERCOLATER. 9-cup. Guaranteed against breakage from heat or cold. C—4708 SKOTCH KOOLER. Perfect for outings or as ice cube keeper. Fibreglas-insulated. Plastic tray. 4-gallon capacity. D—1767 BART STARR OFFICIAL FOOTBALL BY MacGREGOR. Grain leather, leather laces, double lining. E—3282 WILSON OFFICIAL BASKETBALL. Tough, tan rubber cover is ideal for playing on any type surface. Official size and weight. F—4285 BAR-MASTER COCKTAIL SET. Enduro stainless steel bar shaker, strainer, jigger, spoon, lime squeezer. Mixing glass has directions and measures for all mixed drinks. G—1435 POKER CHIP RACK. Walnut-finished—revolving base, with place for two decks of cards. Complete with 200 embossed, interlocking poker chips. H—3364 SOVEREIGN TOWEL SET BY MARTEX. Six-piece set includes: two 25" x 48" bath towels, two 16" x 28" guest towels and two 13" x 13" washcloths. Colors: antique gold, robin blue, petal pink and verdian green. Specify color. I—4238 INDIVIDUAL WALNUT SALAD BOWLS BY VERMILLION. Four solid walnut bowls, smoothly turned to reveal the beautiful natural grain of the wood. 6" diameter. J—4874 UNI-FLOAT MARK II LANTERN. With red emergency flasher. Quarter-mile beam, rustproof, actually floats. K—7501 KNIFE & SHEATH/AXE & SHEATH. Bowie Hunter Knife by Schrade-Walden. Overall length: 9¾"; blade 5½", leather sheath included. True Temper Rocket Belt Axe. All steel with nonslip neoprene grip. Heavy head, leather sheath included. L—3525 RONSON VARAFLAME WINDLITE LIGHTER. Gas-powered windproof lighter. Finger-tip flame control. In smart satin and bright finish with engraved design. M—7500 BILLFOLD AND KEY CASE BY BOSCA. Rich black English Morocco. Has magnetic-closing passcase, bill divider, card pockets and key slot. Six-hook key case with snap-closure.

HERE'S YOUR ORDER FORM. PLEASE FOLLOW THE INSTRUCTIONS CAREFULLY.

SYLVANIA MEANS BUSINESS PRIZE ORDER FORM

Account No. 98287-6

Please Print—Do Not Write

Ship Prizes To: _____ Care of _____

Street _____ City _____ State _____ Zip Code _____

QUAN.	PRIZE NO.	NAME OF PRIZE	SIZE	COLOR	DO NOT WRITE HERE

PLEASE FOLLOW THESE INSTRUCTIONS

PLEASE PRINT FULL NAME AND COMPLETE POST OFFICE ADDRESS—If shipment is to be made in care of someone else, to an office or apartment, be sure to give this information.

CLOTHING—State color and accurate size where necessary.

SIZES—Only listed sizes can be furnished.

CDLOR—Where there is a choice of color, specify first and second choice.

Attach the proper number of SMB certificates and mail this completed order form to:

**SYLVANIA MEANS BUSINESS
PRIZE HEADQUARTERS**
4200 Forest Park Blvd.
St. Louis, Mo. 63108

Prize Winner's Signature

Earn valuable prizes in Sylvania's new SMB Dealer Awards Program



Here are the awards you earn

—issued by participating Sylvania Distributors with your purchases of Sylvania picture tubes and receiving tubes. See back cover for details.



250
certificates

A—3498 MacGREGOR TED KROLL GOLF OUTFIT. Consists of 1, 3, and 4 woods, 9 irons (2 to 9 and putter). Deluxe black vinyl bag, 3 head covers, 12 Ted Kroll golf balls. Right-hand only. B—7506 ROYAL CHEF DELUXE PATIO WAGON. Black enamel finish over steel construction, fully enclosed storage area with redwood doors. Extra-heavy 16" x 20" 2-piece grill, 5-position height control, spit and motor. Fire tending access doors, adjustable draft, 44" x 25" x 30" high to cooking area. Removable cutting board. C—7504 INTERNATIONAL SERIES LUGGAGE SET BY HARTMANN. Men's Carry-On and Two-Suiter of Gibraltarized construction, concealed hardware, "Touch-O-Matic" locks. Flexible side panels spring back from hardest blows. ZE PEL protected inside and out against stains. Sof-Tuf vinyls resist scratching—retain natural color. Available in: onyx black or tiger eye brown. Specify color. D—5858 WHITE DELUXE ZIGZAG PORTABLE SEWING MACHINE. Micrometer zigzag adjustment. Left, center, right needle position control. Dial type stitch-length control. Sewing light directly over needle. Complete with carrying case and variable speed foot control. Size: 22" D x 30" H x 17½" W. E—2718 SMITH CORONA "FIGUREMATIC" ELECTRIC ADDING MACHINE. Adds, subtracts and multiplies. Portable, weighs 8 lbs. Adds to 7 columns, totals to 8. Snap-on lid. F—UNDERWOOD-OLIVETTI STUDIO 44 TYPEWRITER. Advantages of a standard machine in a compact lightweight model. Carrying case. 4788 PICA TYPE FACE. 4789 ELITE TYPE FACE. G—4416 ARGUS ELECTROMATIC 570 SLIDE PROJECTOR. 500-watt lamp. 60-slide-capacity magazine. Remote control unit operates focus, forward and reverse change as well as pointer light. Automatic timer. Completely self-contained unit. H—5818 ROYAL HOLLAND PEWTER COFFEE AND TEA SET. Handspun by old-world craftsmen. Will never tarnish, needs no polishing. Set includes: 9-cup coffeepot, 7-cup teapot, sugar bowl, creamer and 19" tray with German silver bottom and pierced pewter rim. I—3005 FOX B-ST DOUBLE-BARREL SHOTGUN BY SAVAGE. Ventilated rib, gold-plated single trigger. Available with 28" barrel in your choice of 12, 16, or 20 gauge; or 26" barrel, .410 gauge. Specify gauge. J—6604 LADY'S RING. Tailored 14K white-gold mounting is set with 4 diamonds and an exquisite Linde Star Sapphire. K—756 OMEGA "SEAMASTER DeVILLE" WATCH. Automatic, waterproof, shock-resistant, antimagnetic. 17 jewels. Yellow gold-filled case. Sweep second hand. Padded leather strap. L—7002 ARGUS SUPER EIGHT MOVIE OUTFIT. Movie camera features instant-cartridge loading, fully automatic electric eye exposure, electric film drive. Universal focus F:1.8 Argus Cintar lens, automatic type A feature and low-light warning in viewfinder. Movie projector features sharp F:1.5 lens, 500-watt brilliance, 400-foot reel capacity, forward, reverse and still. Lifetime lubrication, enclosed reel drives, self-contained carrying case.

Choose from 77 wonders!

A-2083 SUNBEAM RUG CLEANER AND FLOOR CONDITIONER. It scrubs, waxes, polishes and buffs floors; cleans rugs; Automatic liquid dispenser plus 10" brush, 10" scrub pad, reversible buffing pad and adjustable rug-cleaning attachment. B-4236 STATION WAGNER SLEEPING TOASTER. Complete with two 1000-watt, 120-volt tubular elements that are controlled by an infinite heat switch and element selector switch. patterned flannel lining, 6 lbs. of Celacloud filling. Two 98" separating aluminum zippers all around. C-3342 BLACK ANGUS OVEN BROILER-Four tray levels, double-wall insulation; glass door slides out for easy cleaning. Size: 17 1/4" x 10 1/2" x 9". D-5678 PATTY BERG CUP DOMINION 4-IN-1 BUFFET GRILL. Teflon coated on all cooking surfaces. Bakes Florentine design waffles and hors d'oeuvres, grills sandwiches DEFENDER GOLF WOODS BY WILSON. Set of three, right-hand. Aer-Flo shaft with calfskin "reminder" grip. Balanced and matched. E-3684 and opens for double cooking surface. Sliding heat control and signal light. F-4561 TEXAS WARE MELAMINE DINNERWARE. "Mayan" pattern. Guaranteed for two full years against breakage. Stain-resistant cups. 45-piece service for eight. Color-on-color decorated. G-3759 BLACK AND DECKER LAWN TRIMMER 'N' EDGER. Two powerful helpers in one. Use as a trimmer along fences and walls, under shrubbery, around trees and flower beds. As an edger, blade and motor housing lock into vertical position to maintain well-groomed walks and driveways. AC-DC. H-7503 HAIR DRYER/SHAVER. Universal "Smart Set" Hair Dryer. All-in-one plastic case. Four temperature settings and a generous-size hood. Attachment for performing hair and nail polish dryer, and a Lady Schick "Crown Jewel" Electric Shaver. Alabaster white with gold-and-jewel inset design. I-4154 RIVAL PROTECT-O-MATIC ELECTRIC FOOD SLICER. Slices foods automatically. 6 1/2" serrated steel blade. Gleaming chrome finish. Removable, heavy-duty motor. J-3264 THOR 3/4" TWO-SPEED DRILL KIT. Electronically controlled two-speed drill with sanding discs, paint mixer, 9 drill bits, grinding wheel, buffing wheel, wire brush and a screwdriver attachment. K-166 BULOVA "GRACE-MISS AMERICA" WRISTWATCH. 17 jewels. 10-karat yellow rolled-gold-plate top, stainless steel back. Adjustable expansion bracelet. L-573 BULOVA "CENTENNIAL" WATCH. 17 jewels. Yellow gold case, stainless steel back. Adjustable expansion band.



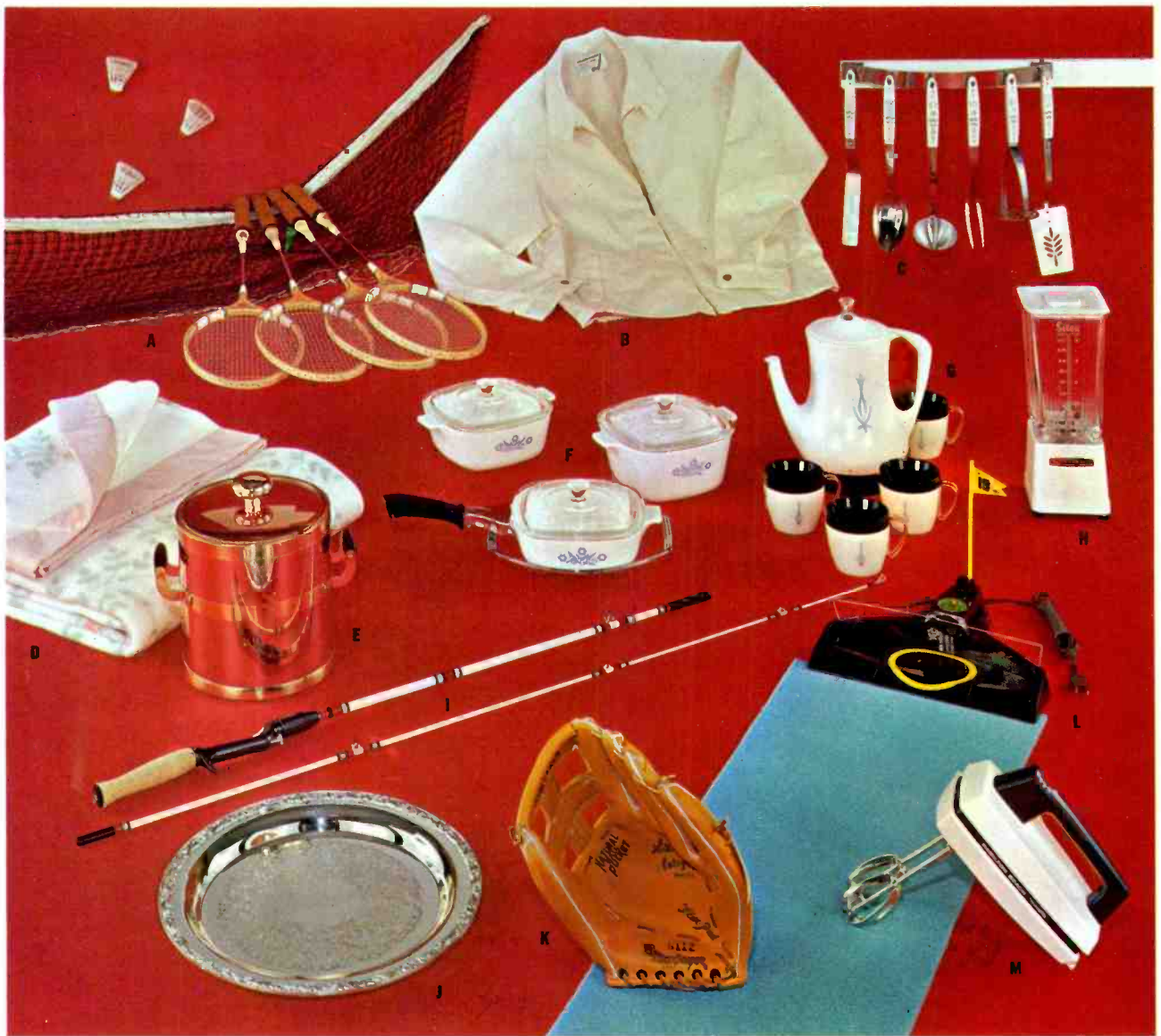

A—4217 SPORTCRAFT 4-PLAYER BADMINTON OUTFIT. Set includes: 4 rackets with steel shafts, leather grips and nylon strings, plus 20' weatherproof net, 3-piece metal poles, shuttlecocks and rules. B—1994 PURITAN "FLIGHT JAC." Perfect action jacket of Dacron and cotton poplin for any casual wear. Wind-resistant, sheds showers. Machine-washable. Sizes: small (36-38), medium (40-42), large (44), or extra-large (46). Colors: oat tan, green or blue. Specify size and color. C—4250 FLINT COOK 'N SERVE TOOL SET. Decorated melamine handles with gleaming stainless steel. Set includes: skillet turner, pot fork, spatula, ladle, potato masher, basting spoon and wall rack. D—1132 FAMOUS "PURREY" BLANKET BY CHATHAM. In white with a delicate "Rose Romance" print in pink. 75% rayon, 25% Acrilan Acrylic fiber. 6½" nylon binding. Winterweight. Size: 72" x 90". E—1417 ICE BUCKET BY KRAFTWARE. Copper and brass-finished metal bucket holds 2 quarts. Keeps ice cubes up to 8 hours. F—3361 STARTER SET BY CORNING WARE. Distinctive all-purpose cookware of super-ceramic Pyroceram. Guaranteed against breakage from heat or cold. Can be used for serving, cooking, baking or freezer storage. Includes: 1-quart, 1½-quart, and 1¾-quart dishes, 1 handle and 1 serving cradle. Includes lids. G—3275 WEST BEND FIESTA 5-PIECE AUTOMATIC COFFEE PAK. Contains a 6- to 10-cup-capacity white polypropylene electric perk... brews delicious coffee... plus easy to clean... will not chip, crack or rust. With 4 matching 7-ounce insulated coffee cups. H—5065 SILEX BLENDETTE. Perfect blender for juices, gravies, sauces and light batters. Removable stainless steel blades. Big 32-ounce bowl graduated in cups and ounces. Unbreakable plastic cover. I—5457 SHAKESPEARE PUSH-BUTTON WHITE TUBULAR WONDEROD. For spin-cast reels. 6½' light model. 2-piece. Stainless steel, spin type guides and top. J—122 ROUND TRAY BY EAGLE WM. ROGERS. Chased center. Ornate applied border. Useful alone as a serving tray or with chafing dish. K—4810 MacGREGOR FIELDER'S GLOVE. Large size Willie Mays Autograph model. Full cowhide lining. "Adjusta-Wrist." "Double T Web" with popular "Tunnel Top Trap." Large size one-piece palm of cork-color leather. Special laces hold pads firmly. L—4076 "THE 19TH HOLE." "Eagle" model. Electromatic cup automatically returns both good and bad putts. Power of return is adjustable for long or short shots. Includes putting green 10 feet long, 12 inches wide. M—3326 HAMILTON BEACH MIXETTE. Three-speed portable mixer. Large beater ejector. Detachable cord. Stands on end, or hangs on wall.

SYLVANIA
 SUBSIDIARY OF
 GENERAL TELEPHONE & ELECTRONICS **GTE**

How you earn prizes in Sylvania's SMB Dealer Awards Program

1.

You can receive SMB certificates from your participating Sylvania Distributor with every order. One certificate for every \$12.50 in purchases of Sylvania receiving tubes, one certificate for every picture tube—SILVER SCREEN 85®, COLOR SCREEN 85, or color bright 85^(TM)

2.

Save the valuable SMB certificates. The more you earn, the wider the range of gifts to choose from. Then select an award that's just right for you from one or more of the appropriate prize groups shown in this folder.

3.

Fill in your choices and all other information on the convenient order form inside this folder. Mail it with the correct amount of SMB certificates to SYLVANIA MEANS BUSINESS Prize Headquarters, 4200 Forest Park Blvd., St. Louis, Mo. 63108. All certificates must be received no later than June 30, 1966. Additional order forms are available from your Sylvania Distributor.

You can get a head start

YOURS FREE: a bonus SMB certificate to use toward any award shown in this folder. Nothing to buy. Simply mail in this coupon to SYLVANIA MEANS BUSINESS, Prize Headquarters.



SYLVANIA MEANS BUSINESS Prize Headquarters
4200 Forest Park Blvd., St. Louis, Mo. 63108.

Please send me my bonus SMB Certificate.

Name _____

Company _____

Address _____

NEW PRODUCTS

More information on these new products is available free from the manufacturers. Each item is identified by a Reader's Service number. Turn to the Reader's Service Card facing page 98 and circle the numbers of the new products on which you would like further information. Detach and mail the postage-paid card.

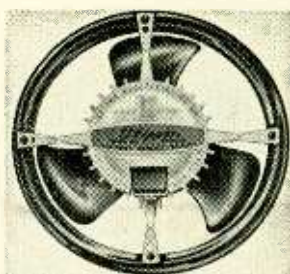

ROTRON SKIPPER FAN delivers 100 cubic feet of air per minute, requires no holes. Fan inserts in same hole required for air flow and is secured by keeper ring. Low, 38-db (SIL), noise level; operates in temperatures up to 140°F.

Circle 46 on reader's service card

NEW-TRONICS CB ANTENNAS. Triple-chrome-plated mast with stainless-steel spring on low profile base, for rooftop mounting. Removable resonator with tip rod for tuning on all channels. May be used with any H.E.L.P. equipment. With 15 feet of cable.

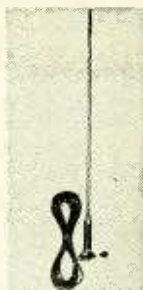

Circle 47 on reader's service card

BASS ENERGIZER, Altec 100A, is passive low-pass filter that connects between amplifier output and speaker input. Compensates for low-frequency deficiencies in small speakers by increasing the very low bass relative to rest of the spectrum. Becomes effective below 150 cycles and



builds to full efficiency from 60 cycles down to speaker's cutoff. Can be used with inefficient speakers if the amplifier power is adequate.—Altec Lansing Corp., 1515 S. Manchester Ave., Anaheim, Calif.

Circle 48 on reader's service card

OCTOBER, 1965

← Circle 40 on reader's service card

BROWNING LABORATORIES NEW LINE OF AUDIO AMPLIFIERS, models MA-325 (25-watt output, illustrated) and MA-216 (16-watt output) for background music and commercial sound applications. Features in common: better

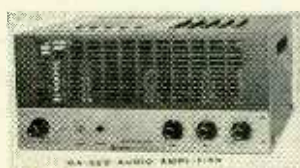

than 1% total harmonic distortion at 1,000 cycles; hum and noise better than 70 db below rated output; solid-state full-wave power supply for operating voltages; 3-position switch with standby position; 3 visual indicators: standby, power-on, audio-overload warning; inputs wired for choice of high-impedance plug or low-impedance transformer; 7-terminal barrier strip for all output choices, 4 ohms, 8 ohms, 25-volt and 70.7-volt systems balanced.

Circle 49 on reader's service card



CLEVELAND INSTITUTE OF ELECTRONICS SLIDE RULE COURSE. Four lesson books, divided into 44 programed sections with over 50 problem-solving examples, can be obtained together with Cleveland Institute's electronics slide rule.

Circle 50 on reader's service card

FM/AM/FM-MPX STEREO RECEIVER, Olson model RA-665. Tuner with 3-tube multiplex section; stereo indicator; stereo headphone jack. More than 35-db separation on FM multiplex. 75-watt stereo amplifier has preamps for magnetic cartridge and separate bass and treble

controls. Tape output jacks on rear. Sensitivity 10 db at 98 mc for 20-db signal-to-



noise. Frequency response: 20–20,000 cycles. Harmonic distortion less than 1%. Output impedance: 4, 8 and 16 ohms. 17½ x 15 x 5½ in.

Circle 51 on reader's service card



SCOTT 100-WATT SOLID-STATE FM STEREO RECEIVER, the 348, combines features of Scott's 260 stereo amplifier and 312 FM stereo tuner. IHF sensitivity 1.9 µv; signal/noise ratio 65 db; harmonic distortion 0.8%; drift 0.02%; capture ratio 2 db; selectivity 45 db; cross-modulation rejection 80 db; AM suppression 55 db; separation 40 db; music power/channel (4-ohm load) 50 watts; steady state power/channel (4-ohm load) 37.5 watts; response 15–30,000 cycles; hum and noise — 80 db. 10½ in. front to rear.

Circle 52 on reader's service card

NORELCO PORTABLE WORLD-WIDE RADIO, model L638. Extended ranges: 517–1,622 kc AM broadcast, 150–415 kc aircraft, 87.5–108 mc FM broadcast, 1.6–4.2 mc marine, 4.2–27.7 on short wave. Short-wave coverage includes 11-, 13-, 16-, 20-, 25-, 30-, 40-, 50- and 60-meter bands. Adjustable afc on FM. Etched-on world map and time dial. Azimuth ring rotating pedestal base for professional navigation use. Ticonal VII speaker. Phono and tape input and

Birnbach's Compact Transistor Audio Amplifier

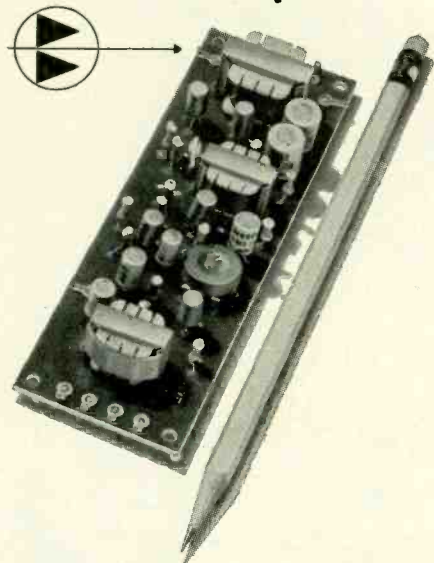

Look at these amazing features . . .

- ★ 5 Transistors and 1 Thermistor
- ★ Shielded Input Transformer with 2 PRIMARY WINDINGS . . . 50 ohms and High Impedance
- ★ Output Transformer with 2 SECONDARY WINDINGS . . . 8 ohms (for speakers), 500 ohms (for modulation and high impedance loads)
- ★ Volume Control included and mounted on Circuit Board
- ★ Low Distortion . . . 400 Milliwatt Push-Pull Output
- ★ Extremely high gain . . . 80 db! Handles low level mikes, phono pickups, telephone pickups, etc.
- ★ Sturdy Printed Circuit Board is 5½" long by 1¾" wide
- ★ Weighs only 3½ ounces
- ★ Power Supply: Any 9-volt DC source
- ★ Amplifier may be run with 15-volt power with an increase in output of 80%
- ★ Standard 90 day warranty

USE IT FOR:

PA System
Hi-Fi System (use 2 for stereo)
Guitar Amplifier
Surveillance Listening System
Electronic Stethoscope
Intercom Amplifier
Modulation for Transmitter
Phono Amplifier
Utility Amplifier
Science Projects

COMPLETE AMPLIFIER \$7.95 each

INCLUDING SCHEMATIC DIAGRAM We Pay Postage!

Available from your local electronics distributor or fill in coupon below:

BIRNBACH Radio Co., Inc.
Dept. R, 435 Hudson St., New York, N.Y. 10014
Please rush me _____ (qty) of your Compact Transistor Audio Amplifiers Model A-300 at \$7.95 each, postpaid. My check or money order for \$_____ is enclosed. Sorry, no COD's.
Name _____
Address _____
City _____ State _____ Zip _____

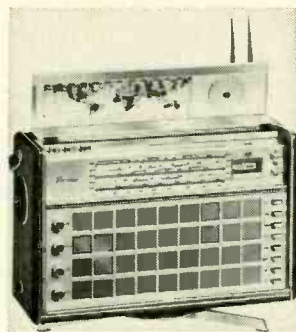

external speaker jacks, automatically retracting earphone, ferrite rod, directional loop and telescopic dipole antennas.

Circle 53 on reader's service card



NEW SCOTCH 3M RECORDING TAPE LINE, the *Dynarange Series*, manufactured with special low-noise oxide, said to last 15 times longer than standard tapes, keep heads cleaner. Three types: 201 for economy and stretch resistance; 202 added strength; 203 extra playing time.

Circle 54 on reader's service card

DUAL-CHANNEL 20-WATT AUDIO AMPLIFIER, model SY from Bergen Laboratories. Output impedance: 4 ohms. Input impedance: 3,500 ohms. Sensitivity: 15 mv for 1, 50 mv for 10 watts output per channel. Response: ± 3 db from 40 cycles to 80 kc at 1 watt listening power. Hum and noise better than



60 db below rated output. Less than 0.5% harmonic distortion at 1 kc and 1 watt output. Channel separation at least 40 db at 1 kc for 10 watts output per channel. 9 low-noise industrial type transistors, 7 silicon diodes. 19 x 5½ x 3½ in., 8 lb, standard rack mounting.—Bergen Laboratories, Inc., 60 Spruce St. Paterson, N.J. 07501

Circle 55 on reader's service card



FANON 2-STATION INTERCOM, the *Echo-21*, incorporates signaling cir-

cuit permitting either remote or master to signal even when system is in off position. Operates on 9-volt transistor battery; master and remote connected with 50-foot 2-conductor cable with plugs that jack into the 2 units. Three-transistor push-pull circuit. Distances between stations can be extended to 200 feet.

Circle 56 on reader's service card

INTERNATIONAL RESISTANCE CO.'s line of rectangular infinite-resolution trimmers now available with Teflon-insulated leads. Designated *IRC type 450-00*, they are supplied with three No. 30 AWG stranded Teflon-insulated leads, 11½-in. minimum length. Resistance range



100 ohms to 1 megohm; power rating ½ watt at 70°C; operating range -55°C to +125°C; temperature coefficient 250 parts per million for resistance values from 50,000 to 500,000 ohms. Units have effective electrical rotation of 22 turns, ± 5 turns, mechanical rotation of 24 turns.

Circle 57 on reader's service card

ELPA MARKETING INDUSTRIES will distribute line of tape slicing and editing products; *EDITall* and *EDITabs*. *EDITall KP-21* editing kit contains *EDITall* block for splicing and editing; 3 sheets of 10 each of *EDITabs* tape splices; marking pencil; demagnetized razor blade; instructions.

Circle 58 on reader's service card

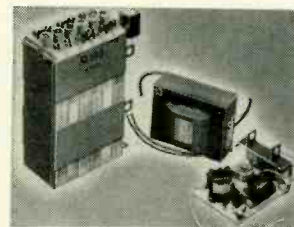

EDMUND SCIENTIFIC BATTERY KIT. 7.2-volt battery composed of six 1.2-volt nickel-cadmium cells hooked in series, housed in strap type steel casing, is recharged by 12-volt transformer and charger circuit board, rectifier and automatic regulator. Line cord, wire, hardware, instructions. Battery is 6 x 6 x 2 in., 2 lb. All cells and batteries supplied with electrolyte and partially charged.

Circle 59 on reader's service card

10 HEATHKIT TEST INSTRUMENTS NOW AVAILABLE FACTORY-ASSEMBLED: the *IM-11 vtvm*, *IM-13* service-bench vtvm, *IM-21* laboratory ac vtvm, *IO-12* wide-band 5-in. oscilloscope,

IG-102 rf signal generator, IG-72 switch-selected audio-frequency generator, IT-11 capacitor checker, IP-20 solid-state regulated dc power supply, IP-32 variable-voltage regulated power supply, IP-12 low-ripple battery eliminator.

Circle 60 on reader's service card

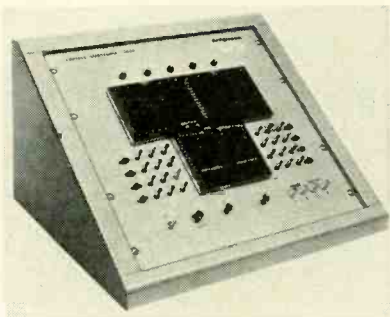

AMPEREX DIGITAL TRAINER, the DT-100, uses interchangeable building-block technique. Has 72 most common solid-state circuit blocks (e.g. flip-flops, gates, pulse shapers, etc.), installed so student and engineer can connect and reconnect at will. Front panel has 3 patch boards with 300 contacts per board. Plugs into 120-volt ac line. Internal power supply. 22 x 22½ x 17½ in.

Circle 61 on reader's service card

SCOTT SOLID-STATE FM STEREO TUNER KIT, the LT-112. All critical circuitry prewired at factory. IHF sensitivity 2.2 µv; cross-modulation rejection 80 db; signal/noise ratio 65 db; dis-

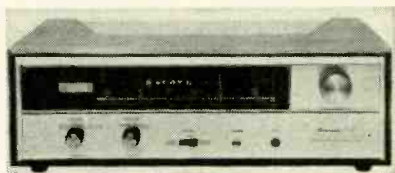

tortion 0.8%; response (stereo) 30-15,000 cycles; capture ratio 4 db; selectivity 45 db; AM suppression 55 db; hum 70 db below 1 volt; separation 35 db. 15 x 5½ x 13½ in., 13 lb.

Circle 62 on reader's service card

WIRELESS FM MICROPHONE, Amphenol Consort, was designed to help priests overcome acoustical problems posed by recent introduction of English liturgy to the mass. Consort is transistorized FM transmitter which picks up voice and broadcasts it up to 200 ft. Signal is picked up by standard FM tuner and fed to PA amplifier.

Circle 63 on reader's service card

ERCONA MARKETS SWEDISH CONDENSER MICROPHONE, the PML EK-61A, has omnidirectional pattern, frequency response of below 30 cycles to above 18 kc ± 3 db. Matching battery-operated power supply model



4317 designed for use with EK-61A, battery life approximately 500 hours. 10 feet each of signal and power supply cable and clamp-on mike stand adapter.

Circle 64 on reader's service card

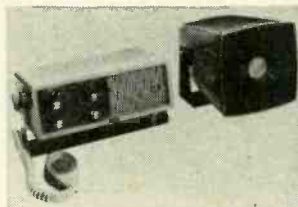

APELCO LOUD HAILER, the AH-100, consists of microphone console and 10-in. waterproofed speaker to install on cabin top or weather deck. Transistorized, operates from boat's 12-volt system; draws less than 1½ amp. Can be reversed electrically to listen for distant warnings in fog.

Circle 65 on reader's service card



POMONA ELECTRONICS COLOR CRT TEST ADAPTER (model 2276) converts existing test equipment to test 90% color tubes. Adapter socket accepts Motorola 23EGP22, RCA 25AP22, and others with miniature diheptal 14BE basing. Standard neo-diheptal 14AL/14AU base matches sockets on current color tube testers.

Circle 66 on reader's service card



KATO ENGINEERING has added a rotary converter rated at 5,000 watts continuous-duty to their line. Will withstand loads of up to 6.5 kw intermittently. Input 115 vdc; output is 60 cycles, 115 volts, single phase at 1,800 rpm. Can also be operated at 1,500 rpm to produce 50-cycle ac. Input voltage 115 dc.

Circle 67 on reader's service card

PRECISION METAL FILM RESISTORS with temperature coefficients

3 WAYS TO BIGGER

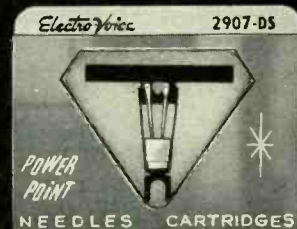

NEEDLE



CARTRIDGE PROFITS!

1. More "look-alike" exact replacement models than any other brand. Over 350 needles, 225 cartridges.
2. Easy-to-use reference material. E-V computer-printed catalogs make proper needle/cartridge selection easy, fast and accurate.
3. Highest standards. Rigid quality control and inspection cuts call-backs, gives full value to every customer.

Stock and sell E-V needles and cartridges for more profits. Pick up your FREE replacement guide at your nearby Electro-Voice distributor today!

ELECTRO-VOICE, INC.
Dept. 1057E, Buchanan, Michigan 49107

Electro-Voice
SETTING NEW STANDARDS IN SOUND

new SAMS BOOKS

Electric Guitar Amplifier Handbook



by Jack Darr. Here's all the practical information needed to enter an interesting and profitable servicing field. Fully explains how each part of an electric musical amplification system functions; provides specific service information for more than 20 commercial instruments, including detailed schematics and drawings of typical circuits, etc. Musical complaints are translated into the language of electronics—faulty components, grid bias, voltages, and waveforms. An easy to understand book by an expert; invaluable for servicemen and musicians interested in the electronics of their instruments. \$2.95

144 pages; 5½ x 8½". Order GAD-1, only . . .

ABC's of Microwaves



by H. Charles Woodruff. The first readily-understandable book on microwaves for the beginner. Clearly explains this complex subject. Illustrated text describes microwave history, formation, transmission, propagation, and reception in terms anyone can understand. An ideal preparation for students, technicians, and hobbyists who may desire to advance into the more complex areas of

this subject. 96 pages; 5½ x 8½". \$1.95
Order AMW-1, only . . .

RECENTLY PUBLISHED BESTSELLER

Color TV Training Manual, New Second Edition

by C. P. Oliphant & Verne M. Ray. This newly revised comprehensive manual is the most up-to-date guide available for technicians preparing to service color TV receivers. Full information on: Colorimetry; Requirements of the Composite Color Signal; Make-up of the Color Picture Signal; RF and IF Circuits; Video, Sync & Voltage-Supply Circuits; Bandpass Amplifier, Color-Sync and Color-Killer Circuits; Color Demodulation; Matrix Section; Color Picture Tube & Associated Circuits; Setup Procedure; Aligning the Color Receiver; Troubleshooting. Includes full-color illustrations invaluable for setup, alignment, and troubleshooting. 224 pages; 8½ x 11". \$5.95
Order TVC-2, only . . .

ABC's of Lasers & Masers (New 2nd Edition)

by Allan Lytel. One of the amazing developments of our times is the laser, a device which produces light radiation capable of performing astounding feats. The revised, up-to-date new edition of this popular fundamentals book explains all the basic principles of both lasers and masers in language anyone can understand. Text and illustrations introduce the reader to the various devices used to produce microwave and light radiation. Practical applications of the devices are described, such as a surgical knife, welding torch, heat ray source, etc. An informative book for students, technicians, and hobbyists. \$1.95
128 pages; 5½ x 8½". Order LAL-2, only . . .

Practical Transistor Servicing (New 2nd Edition)

by William C. Caldwell. Newly revised edition of a very popular servicing book, describing the fastest, most direct methods to troubleshoot transistor radios with maximum profit. Completely practical facts throughout; explains transistor operation in simple terms; tells how to use pretested procedures to quickly and effectively service all types of transistorized equipment (including FM sets). Explains circuit components and their functions, methods for isolating troubles, the meaning of improper voltages, the testing of transistors, troubleshooting auto radios, etc. An essential book for the technician who wants to put his transistor servicing on a sound profit basis. 192 pages; 5½ x 8½". \$2.95
Order PTC-2, only . . .

HOWARD W. SAMS & CO., INC.

Order from your Sams Distributor today, or mail to Howard W. Sams & Co., Inc., Dept. RE-10
4300 W. 62nd Street, Indianapolis, Ind. 46206

Send me the following books:

- GAD-1 TVC-2 PTC-2
 AMW-1 LAL-2

Send FREE Sams Booklist. \$_____ enclosed

Name _____

Address _____

City _____ State _____ Zip _____

My Distributor is _____

Circle 43 on reader's service card

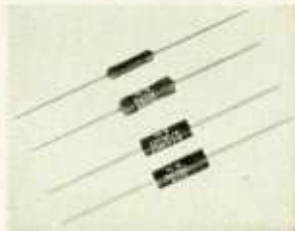

of resistance as low as ± 25 and ± 50 parts per million per °C, types CPMX and CPMF Aeromet series, available from Hi-Q Div. of Aerovox, feature special alloy evaporated on ceramic rods, resulting in atomically bonded film with controlled temperature coefficient of resistance. Tolerance of $\pm 1\%$ standard.

Circle 68 on reader's service card



WINEGARD COMPACT ALL-BAND ANTENNA, the Chroma-Tel, has director system which allows intermixing vhf and uhf directors on same linear plane; impedance correlators for impedance match at each driven element; element spacing of 5¾ in. makes boom half normal length.

Circle 69 on reader's service card

OLSON
"X" AIR
SPEAKER
SYSTEM, model S-677. Magnet develops over 10,000 gauss. Acoustic suspension system. Response: 65-18,000 cycles. Power, 5 watts rms, 15 watts program. Impedance 8 ohms. ¾-in. laminated wood, oiled walnut finish. 6 x 9 x 5 in.



Circle 70 on reader's service card



AVAILABLE FROM ALLIED ELECTRONICS is Knight line of wire and cable. Mil types B, C, D, E; coaxial includes Mil-C-17C polyethylene, Teflon, CATV low-loss foam types. Mike cable, shielded and unshielded intercom cable,

etc. Knight Mil hookup wire with tracers, any color combination, Cable and wire stocked in 25-, 50-, 100-, 250-, 500- and 1,000-ft spools.

Circle 71 on reader's service card

VOICE LETTER, Craig TR-404 Tape Twins. Pocket-size all-transistor recorders weigh 1½ lb each, have capacity

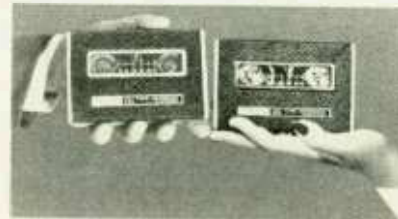

for 30 minutes recording time, come furnished with batteries and microphones.

Circle 72 on reader's service card

CLEVELAND ELECTRONICS REVERBERATION KIT, Series 300, the Babe, for use with 12-volt negative-ground car radios. 4-watt power output, idle current of 0.25 amp. Includes fader



control between speakers on normal or reverb. 6 x 2 x 2½ in. Available in two kit types: RU-304 for cars not requiring speaker and grille; RU-301 for cars requiring them.

Circle 73 on reader's service card

SONOTONE HIGH-COMPLIANCE SPEAKER SYSTEM KIT, the RM-1K, acoustic suspension, contains linear high-compliance woofer, high-frequency



tweeter, L-C crossover at 5,000 cycles, high-frequency level control, wires, hardware, unfinished birch veneer cabinet. Output 40 watts average, 80 watts peak. Response, 45-20,000 cycles. Impedance 8 ohms. 14½ x 10½ x 7¼ in., 12 lb.

Circle 74 on reader's service card

E. F. JOHNSON BUSINESS/INDUSTRIAL 2-WAY RADIO, the *Messenger 600*. FCC type-accepted for use in Public Safety, Industrial and Land Trans-



portation Services in 25-50-mc range. 85 watts AM, the 600 will maintain base-mobile communications over distances up to 35 miles. 5 3/8 x 11 x 10 in. 19 lb.

Circle 75 on reader's service card

UTC SOUND announces new members of the Maximus speaker family, *Maximus 4, 5, 6, 7*, all employing cushioned-air pneumatic-suspension technique. *Maximus 4* (shown) has 8-in. woofer, shielded,



back-loaded mid-treble lens speaker; L-C crossover at 1,800 cycles with continuously variable contoured acoustic control; response flat from 35 to 20,000 cycles; 40 watts; 8 to 16 ohms impedance; 21 1/2 x 11 1/2 x 11 1/2 in.

Circle 76 on reader's service card

AEROVOX MOLDED CERAMIC CAPACITORS, types *MC70* and *MC705*, suited to printed-circuit and "cordwood"



applications; capacity range of 10 to 20,000 pf. Manufactured in uniform molded case with gold-plated Dumet leads.

Circle 77 on reader's service card

FINNEY COMPANY has new line of transistorized uhf/vhf converters, the *FINCO U-Vert 100, 200, 300*, delivering full-power frequency coverage for chan-



nels 14-83, low noise figures and conversion loss. The 100 is recommended for strong signal areas; the 200 for metropolitan locations; the 300 for fringe and deep-fringe areas.

Circle 78 on reader's service card

INTEGRAL IGNITION SHIELD the *Mercury Super 7*, for interference-free mobile communications use, land or marine, each kit custom-made for your engine. Aircraft shielded sparkplugs, dis-

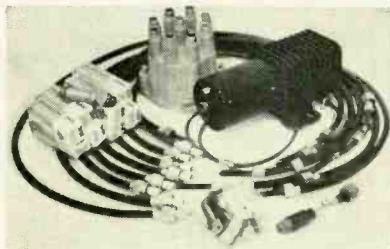

tributor cap with copper-iron-clad full shield, heavy-duty finned shielded coil assembly, aircraft type cables, threaded cable connectors, timing adapter—whole thing waterproof, instructions.

Circle 79 on reader's service card

END

DON'T BELIEVE EVERYTHING YOU SEE

Too often we take our test instruments for granted. But they're only electronic, and—aside from just plain failures—they can lead you down the wrong path. Read how to avoid annoying and costly mistakes by learning how your instruments work, and checking them as you use them.

Coming In November
RADIO-ELECTRONICS

Update your present test equipment to UHF...

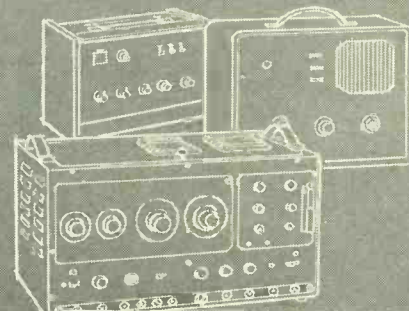

with the new LECTROTECH U-75

UHF TRANSLATOR

For Color and Black and White

Instantly converts VHF signals from Channels 2 through 6 to UHF Channels 15 through 75 without wiring or modification. The only UHF translator with tuned VHF input for sharpest image . . . no unwanted signals. No existing test equipment provides a UHF signal for servicing UHF sections of TV sets or UHF converters. Now, the U-75 converts VHF signals from analyzers, color bar generators, test pattern and AM signal generators or regular VHF TV programs to UHF for test purposes. Connects in a flash . . . simply dial channel desired for color or black and white signal. A precision instrument in rugged steel case for shop and field servicing. 300 and 75 ohm impedance matched inputs. Less battery **\$3950** Only **\$3950**

One Year Warranty

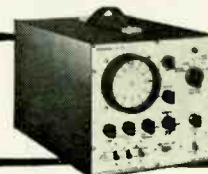

Manufacturers of the famous **V7**—the only complete Color TV Test Instrument. Complete. **18950**

See your distributor or write Dept. RE
LECTROTECH, INC.
1737 Devon Avenue, Chicago, Illinois 60626
Circle 44 on reader's service card

problem solving micro-phones

by SHURE

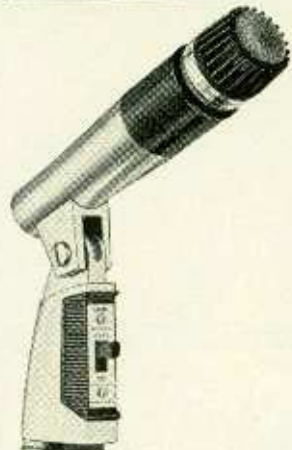

PROBLEM:
Feedback

SOLUTION:
Unidyne III

ULTRA-COMPACT UNIDIRECTIONAL MICROPHONE

Shure's true cardioid microphones with pick-up pattern symmetrical about the axis in all planes, at all frequencies! Solves more common P.A. system problems than any other microphone made: effectively controls feedback caused by sound reflections or spurious frequencies. Also suppresses reverberant "boom." Uniform pattern without "hot spots" or "dead" areas; ideal for distant pick-up, group coverage with one microphone, or multiple microphone set-ups. Model 545S with Switch—List \$89.95.

budget a problem too?



LOW COST UNIDYNE A

In the quality tradition of the famed Unidyne family. Gives unidirectional problem solving ability at an omnidirectional price... makes it possible to effectively control feedback even in low budget P.A. systems. Choice of impedances. Low Impedance model 580 SB only \$52.00 List.

write for data sheets:

SHURE BROTHERS, INC.
222 Hartrey Ave.
Evanston, Illinois

Circle 45 on reader's service card

NEW LITERATURE

All booklets, catalogs, charts, data sheets and other literature listed here are free for the asking (except where a price is given). Each item is identified by a Reader's Service number. Turn to the Reader's Service Card facing page 98 and circle the number of items you want. Then detach and mail the card. No postage required!

BULLETIN, Birnback Stretchable Wire and Cable for Many Applications. 2-page spec sheet on cable types, jacket materials, AWG conductor sizes and properties.

Circle 80 on reader's service card

ANTENNA ROTATOR BROCHURE from Alliance Mfg. 4-page, 2-color illustrated description of complete line of rotators for TV, FM, CB and ham antennas. Brochure T-23. Specifications, prices.

Circle 81 on reader's service card

1965-66 CATALOG, 8 pages, describes Russel Industries' *Shieldmu* tape and foil and *Shieldflex* flexible tubing. Includes: diagrams, alloy-content tables, applications, price lists.

Circle 82 on reader's service card

10-PAGE CATALOG has detailed specifications for *Sealectoboard Programming Boards*, a modular system using off-the-shelf components for various system requirements. Program pin details, available cable terminations.

Circle 83 on reader's service card

PHOTO-ELECTRIC CHOPPER/RELAY Catalog F-5186, 4 pages, describes use of James Electronics Photocom chopper as signal modulator and comparator, plus performances characteristics and application notes on 10 models.

Circle 84 on reader's service card

TOOLS, Terminals Master Catalog MC-1, 150 pages, heavy-stock cover, of Vaco Products' line of screwdrivers, nut drivers, terminals and crimping tools, pliers and wrenches, specialty tools, display and carded items, business gift and premiums; all color-coded.

Circle 85 on reader's service card

DATA SHEET, Brochure No. 2271 specs and illustrations of Ampex AG-100 CUE-MATIC magnetic mat recorder/reproducer, which uses magnetic mats instead of tape reels or cartridges for broadcast-studio sound recording.

Circle 86 on reader's service card

VARIABLE TRANSFORMERS, Powerstat Bulletin PC465. Describes how Superior Electric's new epoxy-coated *Powerkote* coils increase current ratings, life and resistance to contamination of their *Powerstat* variable transformers. Single fold-out sheet.

Circle 87 on reader's service card

AMPEREX SEMICONDUCTORS CONDENSED CATALOG, 34 pages plus 6-page fold-out of outlines and application reports. Reference lists, technical data, indexes of transistors, diodes, rectifiers. Illustrated.

Circle 88 on reader's service card

TELONIC INDUSTRIES' SKAN-A-SCOPE DISPLAY UNIT is described in an 8-page booklet, illustrating the instrument's ability to show 5 displays simultaneously on a 17-in. CRT in a unit containing its own power supply. *Catalog SK-65*.

Circle 89 on reader's service card

INTERNATIONAL RECTIFIER NEWS, Spring Issue/1965, 8 pages with curves, graphs, describes the epitaxial controlled rectifier, and turn-on characteristics and some variables of controlled rectifiers.

Circle 90 on reader's service card

THOMAS & BETTS CONNECTORS AND ADAPTERS BROCHURE, Catalog T-60, 12 punched pages. Step-by-step installation guide on

Shield-Kon system for terminating and grounding braid on multiple shielded or overall shielded cables; new tools for extracting leads illustrated, plus connector and adapter catalog information.

Circle 91 on reader's service card

GENERAL CATALOG & REPLACEMENT GUIDE FOR 1965-66 from Merit Coil & Transformer Corp. 152 pages, looseleaf-punched, indexed, illustrated—full line of color and black-and-white television, high-fidelity, radio components.

Circle 92 on reader's service card

TECHNICAL BULLETIN, 143, on IERC's Ther-Mate silicone heat-sink compound. One looseleaf data sheet on this heat-conducting paste for use between semiconductor cases and heat sinks. (Comes in a syringe applicator.)

Circle 93 on reader's service card

FOLDER—GENERAL ELECTRIC'S COMPACTRONS FOR HIGH B+ TV SETS, ETG-3982. Charts, drawings, applications, information on operation, mounting versatility.

Circle 94 on reader's service card

AEROVOX CATALOG 14-RG, Cinema Precision Wire-Wound Resistors. 16 pages of photos, drawings, specs of complete Cinema line of wire-wound resistors.

Circle 95 on reader's service card

PEARCE-SIMPSON 2-WAY RADIO BOOKLET, The Modern Approach to Business Communications, tells the businessman what land mobile radio service is; information on licensing, guide to equipment, principles of two-way communications. 18 pages, illustrated.

Circle 96 on reader's service card

HI-Q DIVISION OF AEROVOX has a new data sheet on low-temperature-coefficient, precision metal-film resistors.

Circle 97 on reader's service card

LANSDALE TRANSISTOR & ELECTRONICS Product Bulletin 2N2904 describes the 2N2904, -05, -06 and -07 p-n-p epitaxial silicon planar transistors: maximum ratings, electrical characteristics, switching characteristics, parameter measurement data. Single looseleaf sheet.

Circle 98 on reader's service card

AMERICAN RELAYS Catalog No. 765, 32 pages; photos, prices and specifications of components from accelerometers to variable transformers.

Circle 99 on reader's service card

BRACH INDOOR ANTENNA CATALOG, 6-page foldout, photos and partial descriptions of line of uhf and vhf TV antennas, including new "Prism" model, designed for color TV.

Circle 100 on reader's service card

TACO ETV FREQUENCY CHART quickly identifies all segments of the band assigned to Education Television Fixed Services. Group, channel number and band limits in megacycles are supplied.

Circle 101 on reader's service card

THOR ELECTRONICS 1965 Wholesale Electronic Tube Price Catalogue, 8 pages, punched. Lists over 2,500 tubes by type with their prices.

Circle 102 on reader's service card

'Round The World Cruise Only \$159.95



DEPARTURE TIME:
10 Hours After
Opening The Carton

Travel Anywhere In The World, First-Class, On Longwave, Standard AM, FM, and 7 Shortwave Bands with this New Heathkit All-Transistor Portable

Tour The Voice Capitals Of The World. Your round-trip ticket to unsurpassed global listening is always ready when you own this superb new Heathkit 10-Band Portable Radio. You are there when it happens, experiencing the high-key drama of shortwave listening. Seven bands tune 2 to 22.5 mc, offering thousands of daily broadcasts for foreign stations, ships at sea, amateur radio operators, weather stations. The longwave band of 150 to 400 kc brings you the informative broadcasts of aircraft beacon and marine weather stations. The entire FM band of 88 to 108 mc, with rare sensitivity and fidelity in a portable, affords the quiet, crystal-clear beauty of good FM music. And, of course, the standard AM broadcast band is always ready with pop music, news and sports, presented with a sharpness of tuning that permits receiving stations you never before were able to hear.

16 Transistors, 6 Diodes, 44 Factory-Built And Aligned RF Circuits assure cool, instant operation, superior performance, long life, and easy assembly. Two separate AM and FM tuners are ready to drop into place (the FM tuner and IF strip are the same components used in deluxe Heathkit FM Stereo equipment).

Two Built-In Antennas . . . one, a powerful ferrite rod for longwave and AM reception, is neatly housed in the easy-carry handle. The other, for FM and Shortwave, extends to a

full 5 feet and tilts in any direction for peak reception; conveniently telescopes into the cabinet for traveling. In addition, connectors for external AM and FM antennas are provided.

Convenient, Versatile Controls. Like the Battery-Saver Switch that reduces power to 150 milliwatts for normal indoor listening (cuts battery drain as much as 35%), or boosts power to 500 milliwatts for strong, outdoor reception. The handsome rotating turret dial scale is directly driven by a 10-position selector, permits easy viewing of any single band (a log scale is provided for re-locating unknown stations). There's a battery saving Dial Light Switch for nighttime use; Automatic Frequency Control with on-off switch for drift-free, accurately tuned FM; a big, 8½ revolution Tuning knob easily separates stations; a combination on-off-volume control; and a continuous Tone Control for listening as you like it.

Big 4" x 6" PM Speaker, specially designed to match cabinet acoustics, insures "big set" sound. In addition, an earphone is included which plugs into the built-in jack for private listening.

Inexpensive, Flashlight Battery Power. Uses 6 "D" size batteries to operate the radio, plus 1 "C" battery for the dial light (batteries not included). Also operates on 117 VAC with the

optional converter/charger available (plugs into built-in jack to "float-charge" batteries while you enjoy good listening without battery drain).

Deluxe Styling Matches Its Deluxe Performance. Jet black extruded aluminum front and back panels contrast with luxurious chrome-plated, die-cast end pieces to present a rugged, handsome unit you'll be proud to take anywhere. Hinged front and back panels open and close easily thanks to special magnetic edges . . . no cumbersome snaps or latches. Inside the front panel you'll find a hard-bound "listener's guide" book containing frequencies of worldwide Shortwave and U.S. FM stations plus a special map for easy conversion of world time zones. It travels snugly in its own special slot in the front panel.

Build It In 10 Hours Or Less! Since the two tuners and all R.F. circuits are preassembled and factory-aligned, you merely mount this entire section on the chassis and wire 3 small circuit boards. The lucid Heathkit Construction Manual and thoughtful design make it easy to complete without special tools or instruments.

Send For Your World Tour Ticket Now . . . use the coupon below to order your new Heathkit 10-Band Portable. Kit GR-43, 17 lbs. \$159.95

FREE! 1966 Heathkit Catalog



108 pages . . . many in full color . . . describe this and over 250 easy-to-build Heathkits. Save up to 50%. Mail coupon for your FREE copy.

HEATH COMPANY, Dept. 20-10
Benton Harbor, Michigan 49023

- Enclosed is \$ _____, plus shipping.
Please send GR-43 portable.
 Please send FREE Heathkit Catalog.

Name _____
Address _____
City _____ State _____ Zip _____

Prices & specifications subject to change without notice.

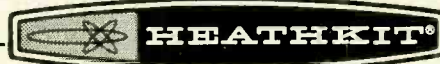

Circle 106 on reader's service card

Look What's

NEW LOW PRICES

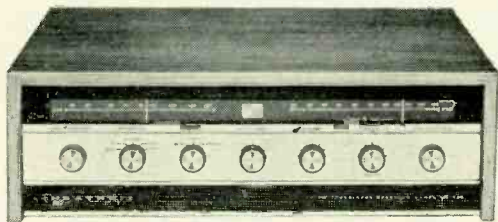

Kit AR-13A
Now Only
\$184⁰⁰

ALL-TRANSISTOR STEREO RECEIVER

Just add 2 speakers for a complete stereo system. AM/FM/FM stereo tuning; 46-transistor, 17-diode circuit for cool, instant operation & natural transistor sound; 66 watts music power @ ± 1 db from 15 to 30,000 cps; walnut cabinet. 35 lbs.

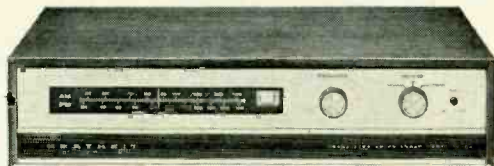

Kit AJ-33A
Now Only
\$94⁵⁰

TRANSISTOR AM/FM/FM STEREO TUNER

Features 23-transistor, 8-diode circuit; built-in stereo demodulator; automatic switching to stereo; stereo indicator light; stereo phase control; filtered outputs for beat-free recording; walnut cabinet. 17 lbs.

OTHER NEW LOW-PRICE COMPONENTS

- ★ Kit AJ-41 (tube), AM/FM/FM Stereo Tuner... Now Only \$112.50
- ★ Kit AJ-12 (tube), FM/FM Stereo Tuner... Now Only \$65.95
- ★ Kit AJ-13 (tube), FM/FM Stereo Tuner... Now Only \$47.00
- ★ Kit AJ-63 (tube), Mono FM Tuner... Now Only \$37.50

Now Install Any Of 3 Ways . . .
Wall, Custom Or Heath Cabinets!

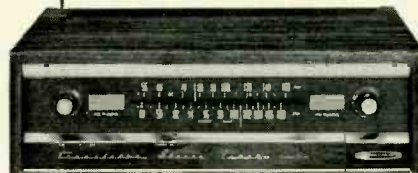

Kit AJ-43D
Now Only
\$109⁰⁰
(less cabinet)

Deluxe Transistor AM/FM/FM Stereo Tuner

25-transistor, 9-diode circuit; automatic switching to stereo; stereo indicator light, stereo phase control; filtered outputs. 15 lbs. Optional cabinets, (walnut \$12.95), (metal \$6.95).

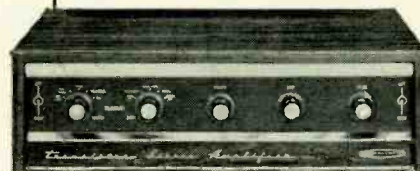

Kit AA-21D
Now Only
\$137⁰⁰
(less cabinet)

Matching 100-Watt Transistor Stereo Amplifier

70 watts RMS power at ± 1 db from 13 to 25,000 cps; 26-transistor, 10-diode circuit; inputs & outputs for any source; 4, 8 & 16 ohm speaker impedances. Opt. cabinets, (walnut \$12.95), (metal \$6.95). 23 lbs.

New Low Price On Deluxe 21" Color TV

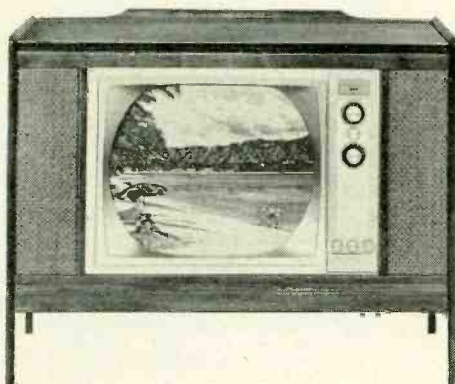

Kit GR-53A
Now Only
\$375⁰⁰
(less cabinet)

Ends costly color TV servicing . . . only set you adjust and maintain yourself. Only Color TV you can install 3 ways . . . wall, custom or Heathkit cabinets. Tunes all channels for 21" of the best color pictures in TV plus true hi-fi sound. Assembles in just 25 hours . . . no special skills needed . . . all critical circuits preassembled and aligned. 1-year warranty on picture tube, 90 days on all other parts. 127 lbs. Also new low prices on preassembled Heathkit cabinets: GRA-53-7, walnut cab. (illust.) 85 lbs. . . \$108; GRA-53-6, walnut-finish hardboard cab., 52 lbs. . . \$46.50

New Low Prices On Heathkit®/Thomas Organs

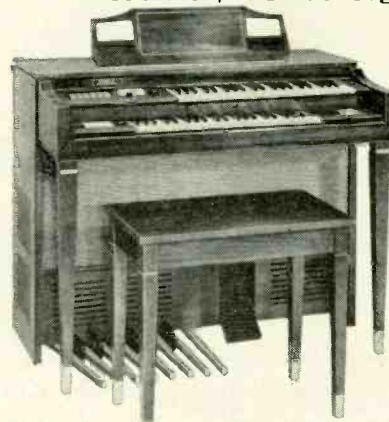

Kit GD-983
Now Only
\$799⁰⁰

The Heathkit/Thomas "Coronado" Transistor Organ, (illust.) boasts 17 organ voices, two 44-note keyboards, Leslie plus 2-unit main speaker system, 28 notes of chimes, 13-note heel & toe pedalboard, color-tone attack & repeat percussion, matching bench, plus many more professional features. 242 lbs. Also the Heathkit/Thomas "Artiste" Transistor Organ with 10 voices, two 37-note keyboards, repeat percussion, etc. now at only \$332. 154 lbs. Both organs have all genuine Thomas factory fabricated components.

NEW At Heath!

NEW KITS

New Transistor FM Stereo Tuner . . .
Build In 6 Hours!



World's easiest to build stereo/hi-fi kit . . . takes 6 hours or less! 14-transistor, 4-diode circuit for cool instant operation, natural transistor sound. Phase control assures best stereo performance. 4-stage IF for high sensitivity. Filtered outputs for direct stereo recording. Automatic stereo indicator light, preassembled & aligned "front-end." Install in a wall or either Heath cabinet; walnut (\$7.95), metal (\$3.50). 6 lbs.

Kit AJ-14
\$49⁹⁵
(less cabinet)

New Deluxe Shortwave Radio

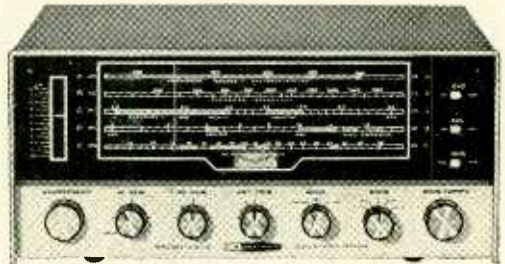

Compare it to sets costing \$150 and more! 5 bands cover 200-400 kc, AM, and 2-30 mc. Tuned RF stage, crystal filter for greater selectivity, 2 detectors for AM and SSB, tuning meter, bandspread tuning, code practice monitor, automatic noise limiter, automatic volume control, antenna trimmer, built-in 4" x 6" speaker, headphone jack, gray metal cabinet, and free SWL antenna. Assemble in 15 hours. 25 lbs.

Kit GR-54
\$84⁹⁵

New 23-Channel, 5-Watt Transistor
CB Transceiver



23-channel transmit & receive capability. All-transistor circuit for instant operation, low battery drain . . . only .75 A transmit, .12 A receive. Only 2 7/8" H x 7" W x 10 1/2" D . . . ideal for car, boat, etc. 1/2 uv sensitivity for 10 db signal plus noise to noise ratio. Front-panel "S" meter, adjustable squelch, automatic noise limiter, built-in speaker, ceramic PTT mike, charcoal gray aluminum cabinet. 8 lbs.

Kit GW-14
\$89⁹⁵
(Assembled
GWW-14,
\$124.95)

New 6-Meter SSB Ham Transceiver

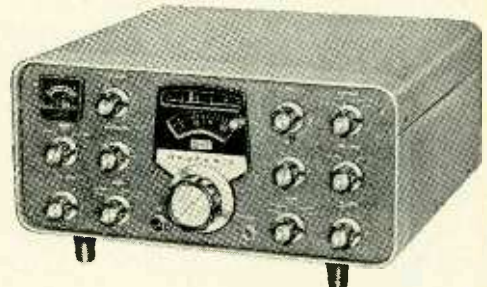

Full SSB-CW transceive operation on 6 meters. 180 watts PEP SSB—150 watts CW. Operates fixed or mobile; PTT and VOX. Switch-selection of upper sideband, lower sideband, and CW. Covers 50-52 mc with crystals supplied, total coverage 49.5-54 mc. Famous Heath SB series Linear Master Oscillator for true linear tuning. Built-in 100 kc calibrator and antenna switching. Accessory mobile mount SBA-100-1 . . . \$14.95. 23 lbs.

Kit SB-110
\$320⁰⁰

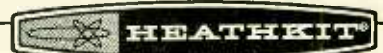

NEW! 1966 CATALOG



Free! 108 pages...many in full color . . . describe these and over 250 easy-to-build Heathkits. Save up to 50%. Mail coupon for your free copy.

... Buy Now—Use This Order Blank ...

HEATH COMPANY, Dept. 20-10, Benton Harbor, Michigan 49023

Please send FREE 1966 Heathkit Catalog.

Model	Description	Weight	Price
Name _____ (Please Print)			
Address _____			
City _____	State _____	Zip _____	

SHIP VIA: Parcel Post Express Collect Freight 20% Included, C.O.D.
 Best Way

All prices & specifications subject to change without notice.

CL-216

Circle 106 on reader's service card

TV Picture on Oscilloscope Screen

HAVING BEEN IN TV SERVICING FOR more than 12 years, I was often inclined to believe I had seen it all. But a little more than a year ago I experienced a bewildering surprise that has modified my thinking. Now I say, "Unless you have seen *this*, you have *not* seen it all!"

I was servicing a Philco TV receiver that had a slight amount of horizontal pulling on the picture. Using my Heathkit model O-10 oscilloscope, I was probing the horizontal sync circuits when suddenly the unbelievable happened: the picture that was on the TV screen also appeared on my scope screen! I blinked my eyes a couple of times and looked again. The picture was still there, locked in on the scope screen.

Thinking out loud that this was impossible, I promptly checked all connections between TV and scope. The only connections were the "hot" lead of the probe connecting the vertical input terminal of the scope to the TV circuit under test (in this case, the sync inverter circuit) and, naturally, the shield of the probe cable, connecting the scope ground terminal to the TV chassis. There was no connection of any kind to the Z-axis (intensity modulation) terminal at the back of the scope. The scope sweep was adjusted for 15,750 cycles.

While the detail of the picture on the scope screen was inferior to that on the TV screen, the resolution was more than good enough to identify the picture. The telecast at that moment was a baseball game, and on a moderate close-up shot of a player the number on the back of his uniform was plainly readable.

Time didn't permit me to investigate further, as I had to repair the set promptly for a dealer. The fault in the set turned out to be a defective filter capacitor in the B-minus circuit of the power supply.

With the next chassis that came on the bench, I tried to simulate the same conditions, but I couldn't, and to this day I haven't seen a TV picture on a scope screen again.

Naturally I tried to explain this phenomenon to myself. Three operations are necessary to reproduce a video picture on a scope. The electron beam must be (a) deflected horizontally at a 15,750-cycle rate, (b) deflected vertically at a 60-cycle rate, (c) intensity-modulated by the video signal. The horizontal deflection is easy: the scope's internal sweep was already set at 15,750 cycles. The vertical sweep is a little more difficult to explain; 60-cycle stray hum pickup in the circuit being investigated could possibly provide the vertical deflection by moving the beam

vertically as it is deflected horizontally. And in this particular TV set, a B-minus filter was at fault, possibly providing a suitable source of hum.

But how was the beam modulated? Even if there had been sufficient video somehow getting into the sync, how could this video information intensity-modulate the beam with no connection to the Z-axis input? Velocity modulation has been offered as an explanation, the theory being that if the beam traces rapidly it produces less brightness than when tracing more slowly. I doubt that, though; I suspect that picture distortion would be much more severe in such a reproduction, compared to the image I saw.

Two more facts are pertinent: Another technician using my oscilloscope observed the same phenomenon once, while checking waveforms in the horizontal sync section of a normally operating (troublefree) G-E set, on my bench. This complicates the story because in that set there could not have been any appreciable amount of hum or video in the sync. Second, I discussed this experience with several local technicians, one of whom reported that he had observed the same effect once. He too was unable to reproduce the effect later with other sets. *His scope is also a Heathkit O-10!* This led me to write the engineering department of the Heath Co., but they could not explain the phenomenon either.

The only explanation I can offer is that an intermittent short or leakage in the electron-gun assembly of the CRT allowed the signal fed to the vertical input terminals of the scope to reach either the grid or the cathode of the CRT. Beyond that, the incident remains a mystery.

Comments are welcome from anyone who has ever had a similar experience or who might be able to shed some light on this strange and perplexing occurrence.—*Lambert C. Huneault*

CALIBRATE YOUR SCOPE

Your oscilloscope—besides being a peek-hole into almost any circuit—is a precise voltmeter, frequency meter, timer or pulse counter. But only if you calibrate it! This article shows you how to do it, with equipment you probably already have. And it points out possible pitfalls, to keep you from throwing away the whole job!

Coming In November
RADIO-ELECTRONICS

WORLD'S FINEST
5-CORE SOLDER

ERSIN MULTICORE

NEW EASY DISPENSER PAK ONLY 69¢

BUY IT AT RADIO-TV PARTS STORES
MULTICORE SALES CORP. PORT WASHINGTON, N.Y.

Circle 107 on reader's service card

Because you've got to SEE it to BELIEVE it.... we will send you a FREE sample!

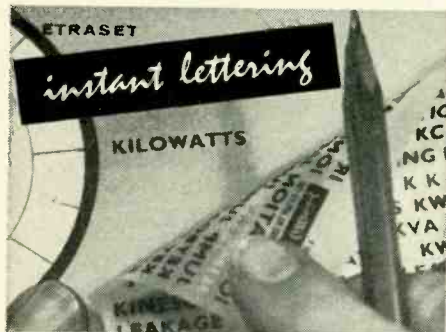

A REVOLUTIONARY NEW METHOD FOR MARKING ELECTRONIC EQUIPMENT

Try this sample and you'll agree "Instant Lettering" is the easiest, quickest way to get professional lettering you've ever seen. Self-adhesive letters printed on a special plastic sheet are just pressed down into position on any equipment, drawing, schematic, etc. Transfers to practically any surface. Looks like printing.

AVAILABLE IN THE FOLLOWING SETS AT \$4.95 EACH.

- TITLES FOR ELECTRONIC EQUIPMENT
- TERMINAL & CHASSIS MARKING KIT
- METER & DIAL MARKING KIT

With these three kits you can completely mark prototype electronic equipment from component parts to finished control panel and meters—and make them look like finished production equipment.

In stock at leading electronics distributors or direct.

SEND FOR FREE SAMPLE AND FOLDER
THE DATAK CORPORATION
63 71st STREET • DEPT. 613 • GUTTENBERG, NEW JERSEY

Circle 108 on reader's service card

DO YOU KNOW HOW
A paper clip can be used for
adjustment of the trimmer?

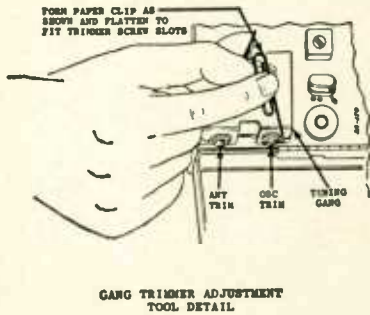

Fig. 1012. A paper clip can be used for adjustment of the trimmer.

For more information, see page 91
in volume 2 of **HOW TO FIX TRANSISTOR
RADIOS AND PRINTED CIRCUITS**

Which of these \$25 electronics self-training programs do you want for ONLY \$2—

with risk-free membership in
the **Electronics Book Club**:
simply take 4 additional books
within a year at low Club prices!

DO YOU KNOW HOW
to draw the circuit for
a manual noise limiter?

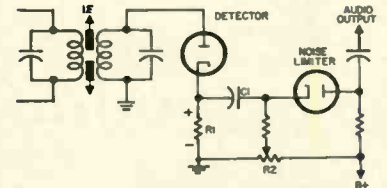

Fig. 918. This noise-limiting circuit has to be adjusted for noise conditions. It is called a manual noise limiter (mnl).

For more information — see page 117
in Volume 2 of **RADIO SERVICING
MADE EASY**

Here is a complete course on fixing transistor radios and printed circuits in **TWO DELUXE, HARD BOUND VOLUMES**. Written by expert, Leonard C. Lane, it was originally developed as a \$25 home study program. It's yours for only \$2 with membership. It treats every aspect of transistors, much of it new, original, unavailable anywhere else in book form. Hundreds of illustrations aid understanding. Completely covers semiconductor fundamentals, how transistors work, transistor types, amplifiers, RF and IF stages, printed circuits, specific servicing methods and techniques. Gives answers to hundreds of questions including those on trouble in the audio section, working with printed-circuit boards, signal generators, the vtvm, defects and repairs, soldering techniques and useful tools, speaker defects, volume control, surface-barrier transistor, silicon transistors, transistors at work, servicing chart, antennas on auto radios, dc to dc converter, and many other subjects.



This important two-volume set was originally prepared as a \$25 home-study course by famed technician and writer Leonard C. Lane. Now you receive *both* deluxe hard bound volumes for only \$2 with membership. Tells you everything you want and need to know about radio servicing in clear, down-to-earth language. Just a few of the many answers you will receive: Working with transistors. Getting started with transistors. Approaching the transistor. Testing transistors and printed circuits. Things to remember. Checking transistors. Servicing transistor radios. Servicing the transistor receiver. Stage-by-stage analysis. Servicing auto radios. Installation and removal. AM receivers. Frequency range. Ac-dc power supplies. Troubleshooting. FM receivers. AM-FM tuners. Why should we have tuners? Communications receivers. Frequency range. Voltage stabilization. Noise limiters. Checking the gain control. Single-sideband reception. Marine receivers. Marine frequencies. The beacon band, etc.

TAKE YOUR CHOICE of either of these outstanding, self-training programs for only \$2—and enjoy these 7 exclusive benefits of membership in the famous **ELECTRONICS BOOK CLUB**: (1) Members are offered the widest possible range of books covering everything in electronics from repair, troubleshooting and building . . . to experimental and hobby projects; (2) The Club saves you up to 30% off retail prices on electronics books that interest you most; (3) Club books are *practical working tools* written to give you clear answers, help you solve problems, increase your know-how and electronics enjoyment; (4) You receive only the books you want because Club News Bulletin tells you about them every other month so you can accept or reject them *in advance*; (5) Special charts and reports are now given **FREE** with many Club selections to expand and illuminate the text; (6) *You need send no money in advance*; you pay for your books *after* you receive and examine them and decide to keep them; (7) **Permanent Risk-Free Guarantee**: if you are ever dissatisfied with a book, you may return it in good condition in 10 days for full credit.

MAIL THIS RISK-FREE COUPON RIGHT AWAY

ACT NOW—YOU'VE EVERYTHING TO GAIN—NOTHING TO LOSE!

Gernsback Library ELECTRONICS BOOK CLUB
c/o Dept. RE-1065
154 West 14th Street, New York, N.Y. 10011

Please enroll me as a member of the Electronics Book Club and send me the TWO VOLUME SET checked below:

How to Fix Transistor Radios and printed Circuits Radio Servicing Made Easy

Bill me only \$2 plus shipping. If not pleased, I may return both books in 10 days and this membership will be cancelled.

I need only accept as few as four additional books a year—and may resign any time after purchasing these four additional books. All selections will be described to me in advance, every other month, in the Club Bulletin, and a convenient form will always be provided for my use if I do not wish to receive a forthcoming selection. You will bill me the special Club price for each book I take. This will often be as much as 30% off retail prices, plus a few cents postage.

Name (please print)

Address

City State Zip Code No.

SAVE POSTAGE COSTS—enclose your payment of \$2 now and we will pay postage. Same return guarantee privilege.

Circle 109 on reader's service card

NEW

from the World Leader
in Soldering Technology

Weller® "PENCIL" SOLDERING IRON

- SMALL • LIGHTWEIGHT
- HIGHLY EFFICIENT

Ideal for miniature soldering, this new 25 watt, 115 volt iron weighs only 1¾ ounces. You can hold and maneuver it as easily as a pencil. Gets into tight places. Does the work of irons having much more weight, much higher wattage. Recovers heat rapidly. Maximum tip temperature is 860°F. Complete with tip and cord. Model WPS. **\$520** list

Now at your Electronic Parts Distributor

WELLER ELECTRIC CORP., EASTON, PA.

Circle 110 on reader's service card

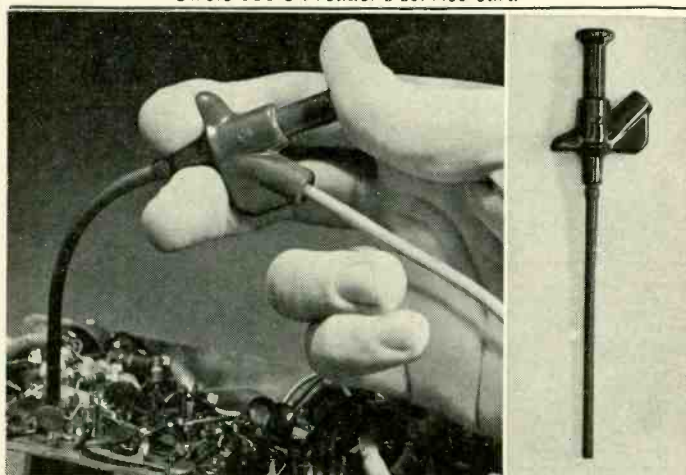

Clever Kleps 30

Push the plunger. A spring-steel forked tongue spreads out. Like this  Hang it onto a wire or terminal, let go the plunger, and Kleps 30 holds tight. Bend it, pull it, let it carry dc, sine waves, pulses to 5,000 volts peak. Not a chance of a short. The other end takes a banana plug or a bare wire test lead. Slip on a bit of shield braid to make a shielded probe. What more could you want in a test probe?

Available through your local distributor, or write to: **\$147**



RYE SOUND CORPORATION
126 Spencer Place, Mamaroneck, N.Y.

Circle 111 on reader's service card

TECHNOTES

UHF TUNER ANTENNA-CONNECTION REPAIR

The antenna connection of a uhf tuner is generally two small prongs that stick up so two small female clips will clip on to them. Many times the antenna lead is pulled tight when the TV back is removed, or when the set is pulled too far out from the wall. If a short antenna connection was made, either the antenna line will break, or there will be a hard pull on the tuner antenna connections.

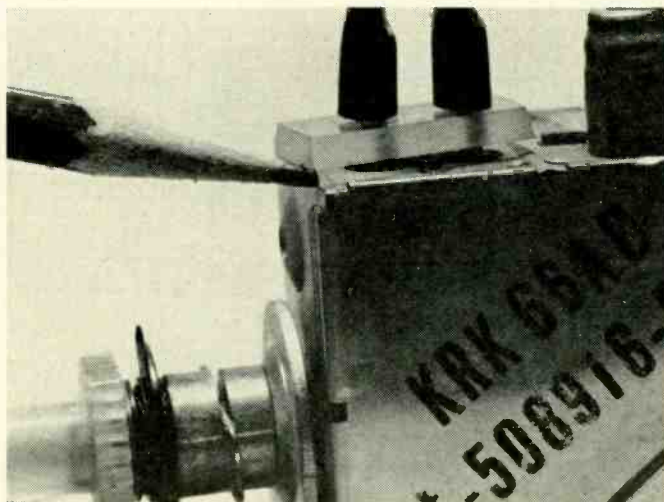

The male prongs generally come through a piece of fiber or plastic. If one side is broken loose, simply take a piece of polystyrene (see photo) and drill two holes to match the antenna prongs. Slip the piece over the two prongs and then solder the antenna connections in place.—Homer L. Davidson

VICTOR 16-MM SOUND PROJECTORS

Many of these projectors, especially older models, develop a speed variation which produces a wow or flutter in the sound. The instruction sheets of some machines give directions for filing the governor points when this occurs, but the

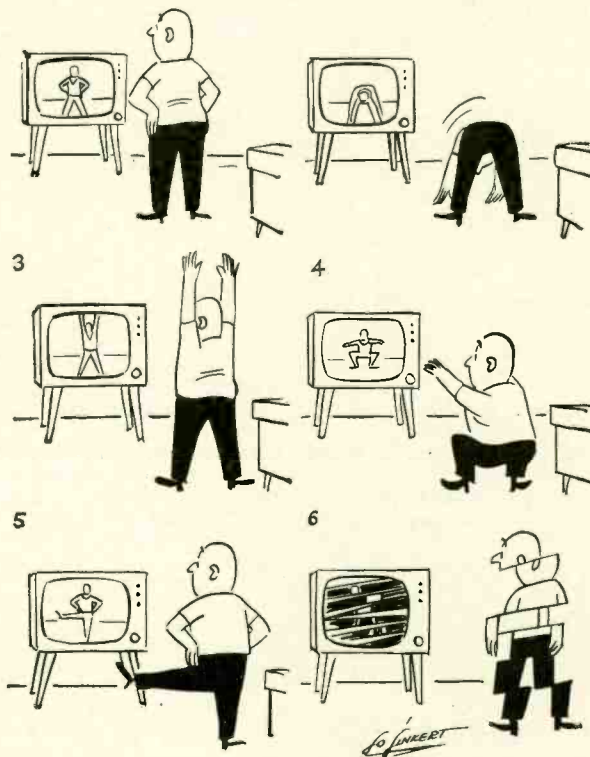

RADIO-ELECTRONICS

speed variation may return. In one movie projector, the speed variations returned after less than 10 minutes' running time.)

On the back of the projector is a 0.5- μ f bathtub capacitor, connected in the governor circuit. If this capacitor is leaky, it will cause speed variation. I have made it a practice to replace this capacitor when servicing an older-model projector, since it is nearly always leaky.

The original capacitor has wire leads cabled into a harness, making replacement complicated. A simpler replacement is a standard 0.5- μ f, 600-volt bathtub with solder lugs. The leads of the original capacitor are clipped off as close as possible to the case, stripped and soldered to the lugs of the new capacitor.

Distorted sound or a change in volume as the projector warms up is often caused by leaky capacitors or off-value resistors in the amplifier. Current-carrying carbon resistors may increase resistance greatly.

Varying volume as the amplifier warms up is most likely to be caused by defective resistors or capacitors in the photo-cell input circuit. Noisy tone or volume controls usually indicate a leaky capacitor applying dc to the control. The 50-volt electrolytic capacitors used as cathode bypasses are frequently open, resulting in low volume, but the filter capacitors seldom cause trouble.—*W. J. Stiles*

STATIC CAN DAMAGE TRANSISTORS

When building transistor circuits, take care to avoid building up a static electric charge on your body or the work area near the transistors. Transistors are very delicate, and junctions can be punctured by an electrostatic discharge. If you do not provide some other discharge path for the charge (which cannot generally be felt), it may flow through the transistor as you pick the unit up or set it down. The transistor is damaged, but there is no indication that anything happened!

To avoid this danger, it is necessary only to provide even a fairly high resistance path (several hundred megohms or so) between your body and ground: and to avoid wearing clothes made of dacron, nylon, rayon, etc. which are good static generators. A concrete or masonry floor is a good return path for a worker in ordinary shoes. A wooden or highly waxed floor or rug provides a poor leakage path.—*James E. Cooper, W2BVE*

ENCLOSED-FIELD PM SPEAKERS FOR COLOR-TV REPLACEMENTS

Ever replace a speaker in a TV set with a larger one, and have the whole raster move an inch to one side? It can happen! The external field of the bigger magnet can reach as far as the CRT neck. Think of what this field will do to convergence on a color tube!

Quam is now building PM speakers especially to meet this problem, with magnets encased in steel. The design confines the external magnetic field of the speaker so that it will not distort the raster. This would make these speakers very useful for replacing the teeny ones on some color sets with larger units. They're available in 3 x 5-, 4-, 4 x 6-, 5 1/4- and 8-inch sizes.—*Jack Darr*

END

NEW DESIGNS IN COMPLEMENTARY AMPLIFIER/SPEAKERS

The idea of designing an amplifier and speaker to be perfect mates for each other has been around for decades. But it never got off the ground commercially—until the past few years, thanks partly to transistors. Now several major hi-fi manufacturers sell complementary systems. Read how they work, how well they work, and what's in sight for the immediate future

Coming In November **RADIO-ELECTRONICS**

OCTOBER, 1965

Live Better Electronically With

LAFAYETTE RADIO ELECTRONICS

FREE!



512
Pages

1966
Catalog
660

Now BETTER THAN EVER

Featuring Everything in Electronics for
• HOME • INDUSTRY • LABORATORY
from the
"World's Hi-Fi & Electronics Center"

Stereo Hi-Fi • Citizens Band • Ham Gear • Tape Recorders • Test Equipment • TV and Radio Tubes and Parts • Cameras • Auto Accessories • Musical Instruments • Tools • Books



CRITERION 1000B
4-TRACK STEREO
RECORDER IN
TEAK CABINET



"PRO-50" COMPACT SOLID
STATE COMPONENT STEREO
MUSIC SYSTEM



50-WATT SOLID STATE
STEREO AMPLIFIER
MODEL 1A-248

Mail the Coupon Today for Your
FREE 1966 Lafayette Catalog 660

LAFAYETTE Radio ELECTRONICS

Dept. JJ-5, P.O. Box 10

Syosset, L.I., N.Y. 11791

Send me the Free 1966 Lafayette Catalog 660

Name

Address

City

State Zip

(Please Give Your Zip Code No.)

Circle 112 on reader's service card

at last...
instant color patterns
at your finger tips...
zero warm-up time



THE ALL NEW SENCORE CG135 DELUXE TRANSISTORIZED COLOR GENERATOR

The big push is on in Color TV. Equip yourself now with the new, solid state Sencore CG135 and cash in on the zooming volume of new service RCA business as Color-TV booms! Instant, service-ready RCA standard color bars, cross-hatch, white dots and individual vertical and horizontal bars enable you to set up or trouble-shoot more Color TV sets per day; earn top money in this fast growing service field. It's an analyzer too: Color gun interruptors, unmodulated video for chroma circuit trouble isolation and unmodulated sync pulses to keep Zenith receivers in sync for this test, make color trouble shooting a snap. Sturdy all-steel construction for rugged, heavy duty in the field or shop. Another Best Buy in profit-building service instruments from Sencore at

\$149⁹⁵

COMPARE THESE FEATURES: SEE WHY THE CG135 IS IN A CLASS BY ITSELF

- Solid state construction employs high priced GE "Unijunctions" to develop six "jump out proof counters" that guarantee stable patterns at all times with no warm-up
- Standard RCA licensed patterns as shown on schematics throughout the industry
- Handy universal color gun interruptors on front panel
- Lead piercing clips insure non-obsolence
- CRT adaptors optional
- Crystal-Controlled 4.5mc Sound Carrier Analyzing Signal to insure correct setting of fine tuning control
- RF output on Channel 4 adjustable to Channel 3 or 5 from front of generator when Channel 4 is being used
- No batteries to run down; uses 115 V AC
- Less than one foot square, weighs only 8 lbs.

professional quality — that's the difference!

SENCORE

426 SOUTH WESTGATE DRIVE • ADDISON, ILLINOIS

Circle 113 on reader's service card

TRY THIS ONE

TANDEM CLIPS SPEED PATCH CONNECTIONS

Making multiple connections to one point in electrical equipment can be difficult. Tandem alligator clips (photo) solve the problem of trying to make four or five clips, probes and wires stay on one wire or terminal.

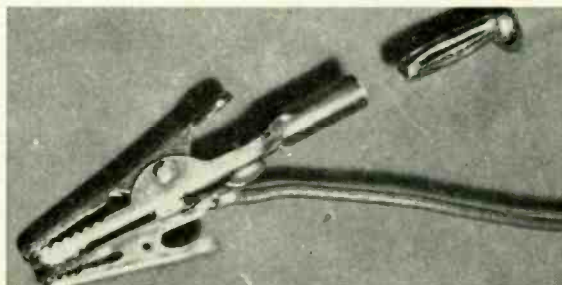

By using clips of different sizes, terminal points of different sizes and shapes can be grasped more easily. Banana plugs can be inserted, pin tips can be clipped, and wires can be soldered to the clips, as shown.

If needed, additional clips of other sizes can be soldered to the two clips shown to provide greater versatility. A five-way binding post soldered to the clips makes an extremely versatile lead connector.

The possibilities and combinations are limited only by your needs.—Robert K. Re

TRANSISTOR CELL OR FLASHLIGHT CELL?

Since the advent of transistor radios, battery manufacturers have marketed two common types of zinc-carbon cells in the D, C, and AA ("penlight") sizes. Heavy loads for short times are best suited to the "flashlight" type cells, while the "transistor" cell is recommended for prolonged use at low current.

Radios are light-load devices that are likely to be used for long periods but transistor recorders and portable phonos are exactly the opposite. A typical portable recorder, the Grundig-Majestic TK1E, draws ¼ amp from four D-cells in series to run the motor. Furthermore, the starting current for this motor flies up to a whopping 650 ma for a second or so before the motor reaches the regulated speed. Four-speed portable phonos have similar characteristics, although usually the starting surge is less. Compare this with the familiar PR-4 two-cell flashlight bulb, which draws only 270 ma.

Think twice about which battery you use.—Steve P. Dow

CHECKING UNMARKED CRYSTALS' FREQUENCIES

How many times while digging through that box of assorted electronic components have you come across some quartz crystals without frequencies marked on the holder?

The method I use to find the frequency of these unknown crystals is quicker than building an oscillator and using Lissajous figures, and still accurate enough for experimental use. I connect the crystal in series with the vertical input of a scope and the hot lead of a signal generator. I tune the generator slowly with the scope sweep set to a low frequency, until the band of vertical deflection on the scope

increases suddenly in height, indicating the series-resonant point of the crystal. Since a crystal is a high-Q component, you must be careful not to accidentally pass the resonant point. Some rf will be coupled capacitively to the scope at all times, but there can be no doubt when the crystal frequency is reached if you tune slowly.

The upper-frequency limit of this technique is determined by the oscilloscope. I used a Heathkit model IO-30 as high as 8 mc with acceptable results. Accuracy is limited by the signal source.

By using crystals of known frequency, a signal source (such as a signal generator, grid-dip oscillator, free-running oscillator) can be set with crystal accuracy and checks of stability made.—*P. Rodger Magriney, K3RYN*

TOOTHPICKS HANDY IN SOLDERING

I find it handy to keep several round double-ended toothpicks close by when I work on printed circuits in building kits or in service.

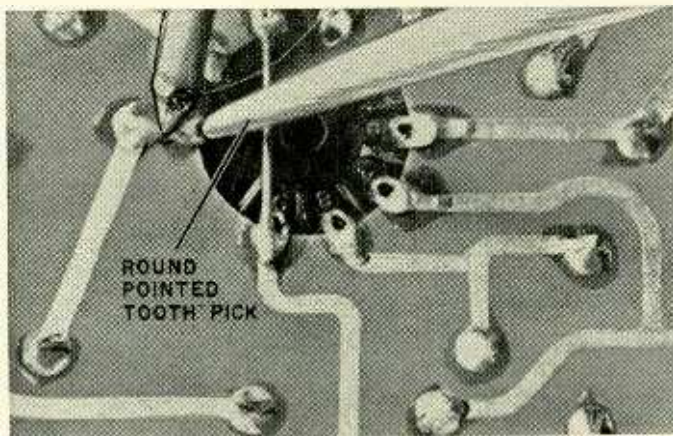

The toothpicks can be used to keep adjacent holes free of solder when I work in close places, or while I solder a part into one hole close to another hole that should be kept clean until later.

In service work, I use them to clear a hole of solder after removing a part.—*Donald Stewart*

TIGHT TUBE SHIELDS SLIDE OFF EASILY

Tight-fitting miniature-tube shields can be slipped off their tubes simply and safely once the tube is out of its socket by using the plastic barrel from any ballpoint pen. Just hold the shield, slip the plastic barrel over the tube exhaust tip, and push the tube down and out of the shield.—*David F. Jacobs*

END

SIGNAL-MAKER ROUNDUP

You'll want to read this most complete directory of every kind of signal-making apparatus used on the shop or hobby bench. Rf signal generators, TV-FM-sweepers, audio sine-and-square generators, FM multiplex generators, markers, color-bar/dot/crosshatch generators. Descriptions, specifications, prices, photographs, give you the facts you want.

Coming in November **RADIO ELECTRONICS**

OCTOBER, 1965

RAY-TEL BY **RAYTHEON**



AND

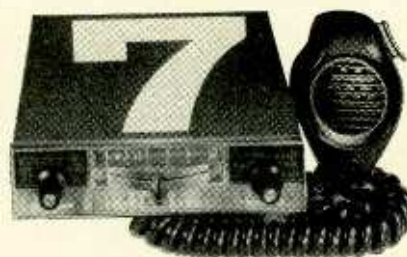

**PERFECT
PAIR...**

**SOLID
STATE...**

**SOLID
STATEMENT**

QUOTE:

Ray-tel, all-transistor C-B radio line, broadest of any in scope, priced to reflect full value at all equipment levels.

This fine line ranges from the sophisticated, full-feature 11-channel TWR-5 intended for personal and business communication systems, to the diminutive 5-channel TWR-7, price and performance peer of all the solid-state mobile radios.

We will be pleased indeed to send you complete details.

Please send details on Ray-tel TWR-5 and TWR-7.

Name			
Number		Street	
City	State	Zip Code	

RAY-TEL
213 E. Grand Ave., So. San Francisco, Calif. 94080

Circle 114 on reader's service card

The following free advertising material is available through

RADIO-ELECTRONICS READER'S SERVICE

- ALLIED RADIO CORP. (Pg. 108-111) Circle 123
508 page 1966 catalog.
- B & K MANUFACTURING CO. (Pg. 23) Circle 17
Complete catalog.
- BLONDER-TONGUE (Pg. 69) Circle 34
Brochure describing "Lab Line" of 75-ohm test equipment.
- BRACH MANUFACTURING CORP. (Pg. 72) Circle 39
Catalog of indoor TV antennas.
- BROOKS RADIO (Pg. 104-105, 106) Circle 119
Catalog sheets and price lists of tubes and parts.
- BURSTEIN-APPLEBEE CO. (Pg. 68) Circle 33
New 1966 giant catalog.
- CAPITAL RADIO ENGINEERING INSTITUTE (Pg. 28-31) Circle 23
Book describing CREI programs in electronics and nuclear engineering technology.
- CASTLE TELEVISION TUNER SERVICE INC. (Pg. 6) Circle 6
Information on complete tuner overhaul by mail.
- CENTRALAB (Pg. 2) Circle 3
Electronics component catalog.
- CLEVELAND INSTITUTE OF ELECTRONICS (Pg. 24) Circle 19
Free electronics slide rule booklet and pocket electronics data guide.
- CONAR INSTRUMENTS (Pg. 66) Circle 31
Catalog on Conar electronic kits.
- CORNELL ELECTRONICS (Pg. 114) Circle 125
Catalog and price list of tubes and parts.
- COYNE ELECTRONICS INSTITUTE (Pg. 113) Circle 124
Book on "Your Opportunities in Electronics."
- DATAK CORP. (Pg. 92) Circle 108
Folder and sample of "Instant Lettering" marking kit.
- DE VRY TECHNICAL INSTITUTE (Pg. 5) Circle 5
Booklets—"Pocket Guide to Real Earnings" and "Electronics in Space Travel."
- EDLIE ELECTRONICS (Pg. 115) Circle 127
32-page anniversary flyer featuring components, tubes and equipment.
- EICO ELECTRONIC INSTRUMENT CO., INC. (Pg. 32) Circle 24
47-page 1965 short form catalog.
- ELECTRONICS COMPONENTS CO. (Pg. 115) Circle 126
Information on rectifiers and transistors.
- FINNEY COMPANY (Pg. 71) Circle 37
Booklets on Finco's Color Ve-Log Antennas.
- GERNSBACK LIBRARY (Pg. 93) Circle 109
Information on special membership offer for Electronics Book Club.
- GRANTHAM SCHOOL OF ELECTRONICS (Pg. 13) Circle 10
52-page booklet "Careers in Electronics."
- HEALD'S ENGINEERING COLLEGE (Pg. 107) Circle 122
Catalog and registration application.
- HEATH COMPANY (Pg. 87-91) Circle 106
1966 Heathkit catalog.
- INTERNATIONAL CRYSTAL MFG. CO. (Third Cover) Circle 149
Catalog on citizens radio transceivers and name of nearest International dealer.
- INTERNATIONAL RADIO EXCHANGE (Pg. 24) Circle 18
Catalog of used, discontinued or traded-in CB sets.
- JFD ELECTRONICS CORP. (Pg. 15) Circle 12
Brochure on 82-channel TV antennas.
- JACKSON ELECTRICAL INSTRUMENT CO. (Pg. 16) Circle 13
Complete catalog on test instruments.
- JERROLD ELECTRONICS CORP. (Pg. 102) Circle 117
Information on new Jerrold Tele-Mate Cordless UHF Converter.
- LAFAYETTE RADIO ELECTRONICS (Pg. 95) Circle 112
1966 Lafayette catalog.
- LECTROTECH (Pg. 85) Circle 44
Catalog sheets covering entire line.
- MALLORY DISTRIBUTOR PRODUCTS CO. (Pg. 17) Circle 14
Information on Mallory MTA molded electrolytic capacitor.
- MERCURY ELECTRONICS CORP. (Pg. 26) Circle 21
Complete Mercury catalog.
- MULTICORE SALES CORP. (Pg. 92) Circle 107
Information on 5-core solder.
- OLSON ELECTRONICS, INC. (Pg. 72) Circle 38
Free 1-year subscription to Olson Electronics Catalog.
- OXFORD TRANSDUCER CORP. (Pg. 14) Circle 11
Complete catalog on commercial sound speakers.
- POLY-PAKS, INC. (Pg. 117) Circle 129
Catalog of semi-conductors.
- PROGRESSIVE EDU-KITS, INC. (Pg. 103) Circle 118
Information describing "Edu-Kits"
- RCA INSTITUTES (Pg. 62-65) Circle 30
Brochure on home study and classroom training.
- RCA TEST INSTRUMENTS (Pg. 25) Circle 20
Information on color bar generators.
- RFS INDUSTRIES (Pg. 70) Circle 36
Information on Balfour Princess automatic/manual turntable systems and name of nearest distributor or dealer.
- RADAR DEVICES MFG. CORP. (Pg. 1) Circle 2
Information on distributorships for Radar Sentry Alarm Systems.
- RADIO SHACK (Pg. 118) Circle 130
Radio Shack catalog.
- RAY-TEL CB PRODUCTS (Pg. 97) Circle 114
Complete details on Ray-Tel TWR-5 and TWR 7.
- RECORD CLUB OF AMERICA (Pg. 7) Circle 7
Information on Record Club with no obligations and guaranteed discounts.
- RYE SOUND CORP (Pg. 94) Circle 111
12-page general catalog of sound accessories.
- SAMS, HOWARD W. CO. (Pg. 27) Circle 22
Information on Photofact Library Encyclopedia deal.
- SAMS, HOWARD W. CO. (Pg. 84) Circle 43
Sams' booklet.

- SCHOBER ORGAN CORP. (Pg. 12) Circle 9
Booklet and 7" "sampler" record.
- SENCORE (Pg. 96) Circle 113
Descriptive literature on Sencore's CG135 deluxe transistorized color generator.
- SHURE BROS., INC. (Pg. 86) Circle 45
Brochure entitled "Fact and Fiction" on cardioid unidirectional microphones.
- SYLVANIA ELEC. CO. (Pg. 73-80) Circle 40
Brochure on electronic tubes.
- TAB (Pg. 116) Circle 128
Information on transistors and diodes.
- TRIPLETT ELECTRICAL INSTRUMENT CO. (Second Cover) Circle 1
New test equipment catalog.
- UNIVERSITY SOUND (Pg. 70) Circle 35
Brochure on high-fidelity speakers and systems.
- WARREN ELECTRONIC COMPONENTS (Pg. 106) Circle 120
Information on silicon rectifiers.
- WEBSTER MANUFACTURING (Pg. 101) Circle 116
Information on the "565" C-B radio.
- WELLER ELECTRIC CORP. (Pg. 94) Circle 110
Descriptive literature on Weller soldering guns.
- WEN PRODUCTS, INC. (Pg. 67) Circle 32
Information on Wen hot rod soldering gun.
- WINEGARD CO. (Pg. 61) Circle 29
Complete information on BC-107.

RADIO-ELECTRONICS READER'S SERVICE
P.O. Box 7365, Philadelphia, Pa. 19101

The numbers I have circled below indicate the material I would like to receive:

1	2	3	4	5	6	7	8	9	10	11	12	13	14	15
16	17	18	19	20	21	22	23	24	25	26	27	28	29	30
31	32	33	34	35	36	37	38	39	40	41	42	43	44	45
46	47	48	49	50	51	52	53	54	55	56	57	58	59	60
61	62	63	64	65	66	67	68	69	70	71	72	73	74	75
76	77	78	79	80	81	82	83	84	85	86	87	88	89	90
91	92	93	94	95	96	97	98	99	100	101	102	103	104	105
106	107	108	109	110	111	112	113	114	115	116	117	118	119	120
121	122	123	124	125	126	127	128	129	130	131	132	133	134	135
136	137	138	139	140	141	142	143	144	145	146	147	148	149	150

VOID AFTER NOVEMBER 30, 1965

Name _____

Address _____

City _____ State _____

10-65N Zip Code _____

Here's how you can get manufacturers' literature fast:

1. Tear out the post card on the facing page. Clearly print or type your name and address.
2. Circle the number on the card that corresponds to the number appearing at the bottom of the New Products, New Literature or Equipment Report listing in which you are interested. For literature on products advertised in this issue circle the number on the card that corresponds to the number appearing at the bottom of the advertisement in which you are interested, or use the convenient checking list in the column at the left.
3. Mail the card to us (no postage required in U. S. A.)

Note: If the postcard has already been detached from your copy of RADIO-ELECTRONICS, use the coupon on this page instead. Enclose the coupon in an envelope and address it to: RADIO-ELECTRONICS READER'S SERVICE, P. O. Box 7365, Philadelphia, Pa. 19101. (Use this address only for Reader's Service requests.)

Putting In An Automatic Degausser

By HOMER L. DAVIDSON

Inexpensive kit, quickly installed, adapts any color TV set so that the picture tube is automatically damagnetized every time the set is turned on.

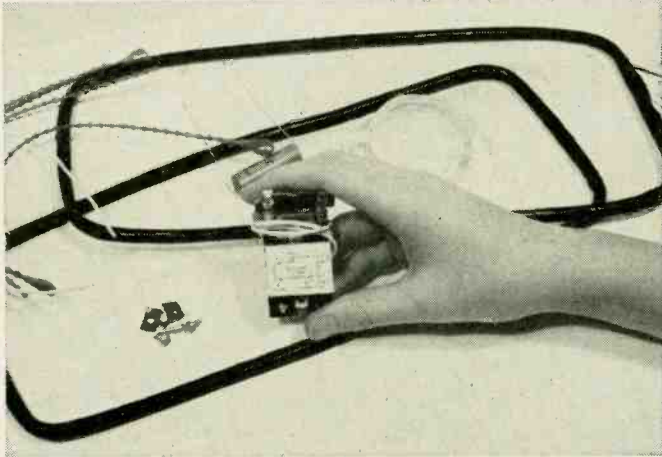

This automatic degaussing kit (the Colman DK-001) contains two degaussing coils, a capacitor, a relay and plastic fasteners. Coils go one on each side of picture tube. When coils are hooked up properly, magnetic field travels from one coil to the other, sweeping entire screen.

Mount relay switch so that white wire reaches set's on-off switch. In many sets, relay switch will mount on tuner assembly. Bimetal element between terminals 1 and 3 on switch is normally closed. When set is turned on, current through degaussing coils demagnetizes picture tube. In about 30 seconds, as thermal element heats, switch opens and set lights up. Tube is degaussed every time set is turned on.

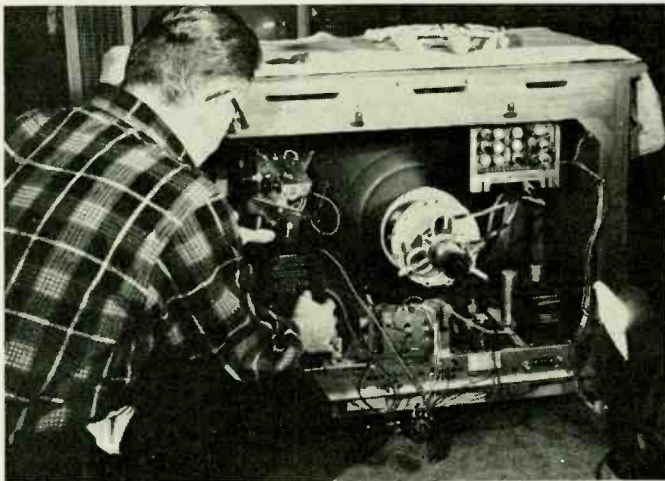
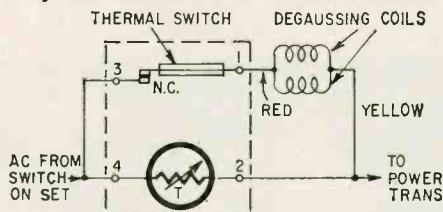

To install kit: remove chassis, but be very careful not to disturb convergence assembly on neck of picture tube.

EIGHT INSTRUMENTS IN ONE

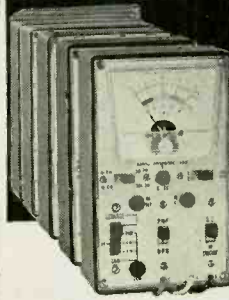

- Out-of-Circuit Transistor Analyzer
- Dynamic In-Circuit Transistor & Radio Tester
- Signal Generator
- Signal Tracer • Voltmeter
- Milliammeter
- Battery Tester
- Diode Checker

Transistor Analyzer Model 212

Factory Wired & Tested — \$18.50
Easy-to-Assemble Kit — \$13.50

YOU DON'T NEED A BENCH FULL OF EQUIPMENT TO TEST TRANSISTOR RADIOS! All the facilities you need to check the transistors themselves — and the radios or other circuits in which they are used — have been ingeniously engineered into the compact, 6-inch high case of the Model 212. It's the transistor radio troubleshooter with all the features found only in more expensive units. Find defective transistors and circuit troubles speedily with a single, streamlined instrument instead of an elaborate hook-up.

Features:

Checks all transistor types — high or low power. Checks DC current gain (beta) to 200 in 3 ranges. Checks leakage. Universal test socket accepts different base configurations. Identifies unknown transistors as NPN or PNP.

Dynamic test for all transistors as signal amplifiers (oscillator check), in or out of circuit. Develops test signal for AF, IF, or RF circuits. Signal traces all circuits. Checks condition of diodes. Measures battery or other transistor-circuit power-supply voltages on 12-volt scale. No external power source needed. Measures circuit drain or other DC currents to 80 milliamperes. Supplied with three external leads for in-circuit testing and a pair of test leads for measuring voltage and current. Comes complete with instruction manual and transistor listing.

EMC, 625 Broadway, New York 12, N. Y.

Send me FREE catalog of the complete value-packed EMC line, and name of local distributor.

NAME _____ RE-10

ADDRESS _____

CITY _____ ZONE _____ STATE _____

EMC

ELECTRONIC MEASUREMENTS CORP.
625 Broadway, New York 12, New York
Export: Pan-Mar Corp., 1270 B'way, N. Y. 1

new Webster band-spanner "565"

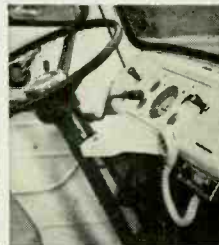

CITIZENS BAND 2-WAY RADIO

Low in price...ultra-compact...high in performance...ideal for business and personal use. Both a 2-way radio and a p.a. system.

Fully transistorized... uses effective planar silicon transistors • Extremely low standby drain on battery—no tube filaments • 5-channels • 5-watts power input • "Tiny-lamp" gives positive indication of amplifier operation and modulation • Two-stage noise limiter • Adjustable squelch • 1½"H, 6¼"W, 7½"D.

Suggested price **\$129⁹⁵**

Please send information on "565" C-B radio

Name _____

Number _____ Street _____

City _____ State _____ Zip Code _____

WEBSTER 317 Roebing Rd. So. San Francisco, Calif.



Circle 116 on reader's service card

- TINY
- TUNNEL DIODE
- TERRIFIC!

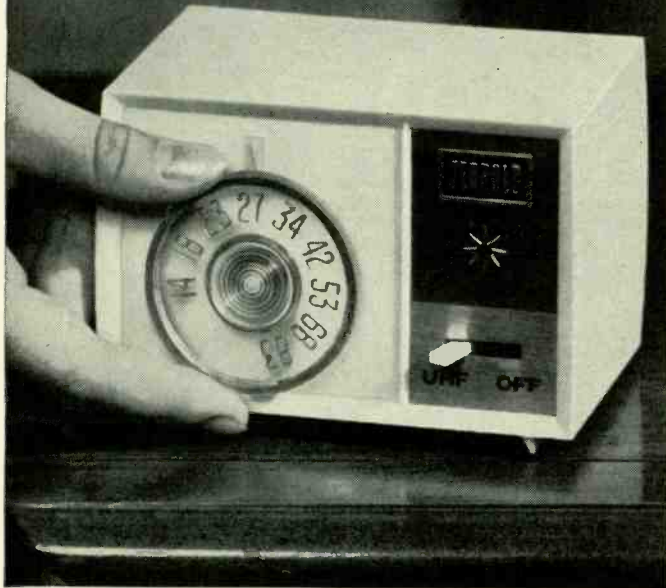

New Jerrold

tele-mateTM

cordless UHF converter

\$19.95 LIST

Jerrold, originator of the famous Powermate antenna amplifier, now brings you the most compact, efficient, and high-style of UHF converters—*Tele-Mate!*

All-solid-state with maintenance-free tunnel-diode design, the new *Tele-Mate* has a low noise figure and needs no warm-up. Works on unused Channel 5 or 6 of any VHF receiver to bring in all UHF channels in the area. At only \$19.95, *Tele-Mate* is by far the best value in the UHF converter field.

See your TV serviceman for the Jerrold *Tele-Mate* or write for name of nearest dealer.

JERROLD

JERROLD ELECTRONICS CORPORATION
Distributor Sales Division
15th & Lehigh Ave., Philadelphia, Pa. 19132

The nation's leading manufacturer
of television reception products

Circle 117 on reader's service card

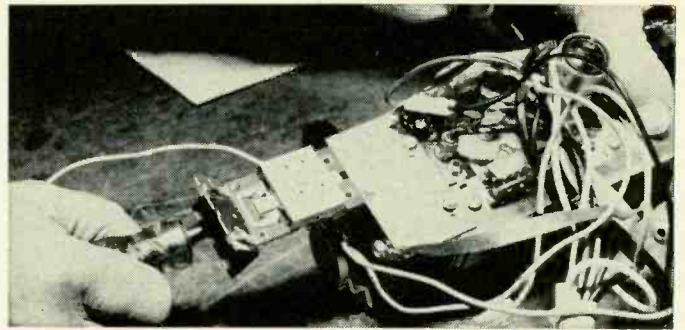

Mount relay on tuner assembly, as close to on-off switch as possible. With an ohmmeter, measure resistance from switch to one side and then the other of interlock plug. One side will read zero ohms, the other between 1 and 3 ohms. Disconnect (from switch) lead that shows most resistance. Solder white lead from relay switch here. Connect lead you have just removed to terminal 2 of relay.

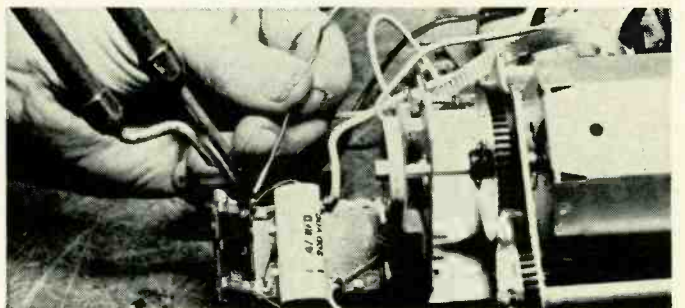

Solder 0.47 μ f capacitor between red and yellow terminals of relay. It prevents arcing across contacts and premature failure.

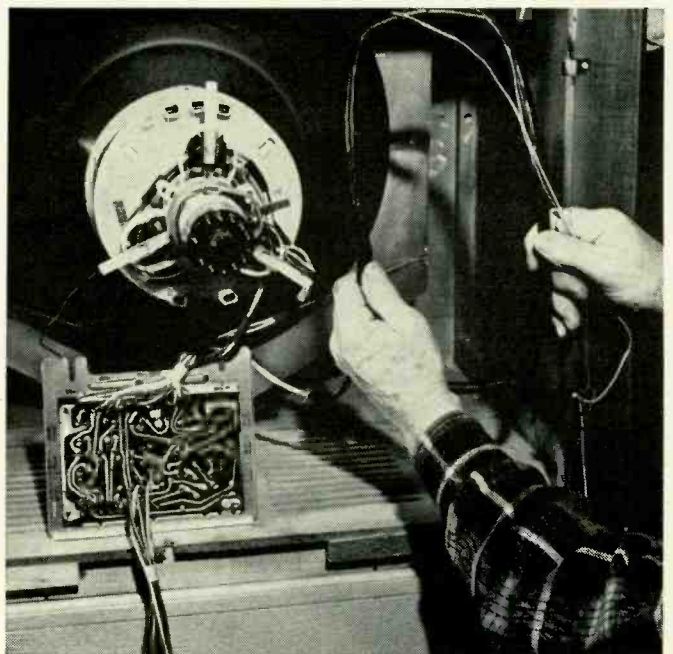

Mount coils one on each side of picture tube. Coil with long leads goes on right as you look into back of set. Its leads will reach across top of tube. Bend both coils to curve around CRT. Place them as far to front of tube as possible. Fasten them down with web fasteners furnished with kit. They can be cut to any length.

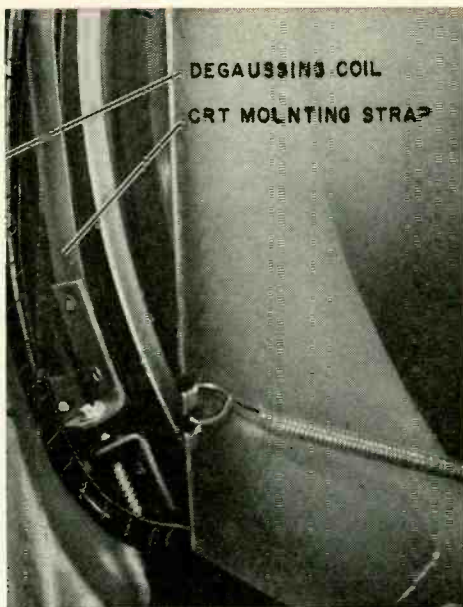

DEGAUSSING COIL
CRT MOUNTING STRAP

A degaussing coil in place. Be sure leads for both coils are at top of tube. They will then be close to switch assembly.

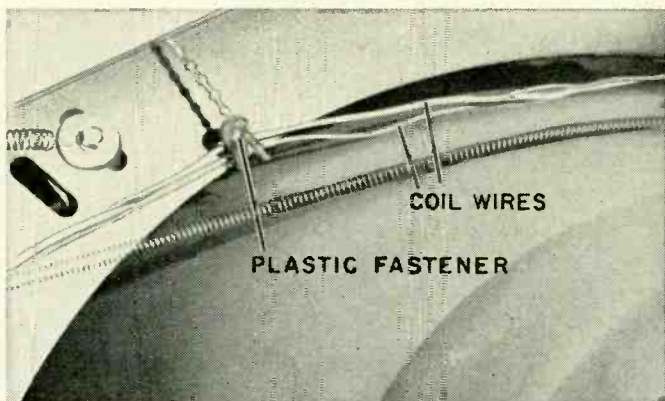

COIL WIRES
PLASTIC FASTENER

These wires are from right-hand coil, held in place with plastic fasteners. Replace TV chassis and plug in the four leads. Yellow leads go to yellow dot on relay switch assembly, and red leads go to red dot.



Turn set on, get a picture, then magnetize screen with strong permanent magnet. Turn set off, let it cool for at least 5 minutes, then turn it on again. Purity should be good. For a dramatic test of degaussing circuit's action, kill blue and green guns, as in convergence setup. Screen should be pure red. Move magnet across screen as before; blue and green streaks will appear. Turn set off, let it cool, then turn it on again. Screen should be pure red. END

BUILD 20 RADIO

CIRCUITS AT HOME

with the New Progressive
RADIO "EDU-KIT"®

Reg. U.S.
Pat. Off.

All Guaranteed to Work!

PRACTICAL only
HOME RADIO COURSE \$26.95

NOW INCLUDES

- ★ 12 RECEIVERS
- ★ 3 TRANSMITTERS
- ★ SQ. WAVE GENERATOR
- ★ AMPLIFIER
- ★ SIGNAL TRACER
- ★ SIGNAL INJECTOR
- ★ CODE OSCILLATOR



TRAINING ELECTRONICS
TECHNICIANS SINCE 1946

- ★ No Knowledge of Radio Necessary
- ★ No Additional Parts or Tools needed
- ★ Excellent Background for TV
- ★ School Inquiries Invited
- ★ Attractively Gift Packed

FREE EXTRAS

- SET OF TOOLS • RADIO & ELECTRONICS TESTER • ELECTRIC SOLDERING IRON • TESTER INSTRUCTION MANUAL • MEMBERSHIP IN RADIO-TV CLUB • CONSULTATION SERVICE • HI-FI GUIDE
- QUIZZES • TV BOOK • FCC AMATEUR LICENSE TRAINING
- RADIO BOOK • PRINTED CIRCUITRY • PLIERS-CUTTERS
- ALIGNMENT TOOL • WRENCH SET • CERTIFICATE OF MERIT
- VALUABLE DISCOUNT CARD

WHAT THE "EDU-KIT" OFFERS YOU

The "Edu-Kit" offers you an outstanding PRACTICAL HOME RADIO COURSE at a rock-bottom price. Our kit is designed to train Radio & Electronics Technicians, making use of the most modern methods of home training. You will learn radio theory, construction, servicing, basic Hi-Fi and TV repairs, code, FCC amateur license requirements.

You will learn how to identify radio symbols, how to read and interpret schematics, how to mount and lay out radio parts, how to wire and solder, how to operate electronic equipment, how to build radios. Today it is no longer necessary to spend hundreds of dollars for a radio course. You will receive a basic education in radio, worth many times the small price you pay, only \$26.95 complete.

THE KIT FOR EVERYONE

The Progressive Radio "Edu-Kit" was specifically prepared for any person who has a desire to learn Radio. The "Edu-Kit" has been used successfully by young and old in all parts of the world by many Radio Schools and Clubs in this country and abroad. It is used for training and rehabilitation of Armed Forces Personnel and Veterans throughout the world.

The Progressive Radio "Edu-Kit" requires no instructor. All instructions are included. Every step is carefully explained. You cannot make a mistake.

PROGRESSIVE TEACHING METHOD

The Progressive Radio "Edu-Kit" is the foremost educational radio kit in the world, and is universally accepted as the standard in the field of electronics training. The "Edu-Kit" uses the modern educational principle of "Learn by Doing." Therefore, you will construct radio circuits, perform jobs and conduct experiments to illustrate the principles which you learn.

You begin by examining the various radio parts included in the "Edu-Kit." You then learn the function, theory and wiring of these parts. Then you build a simple radio. With this first set, you will enjoy listening to regular broadcast stations, learn theory, practice testing and troubleshooting. Then you build a more advanced radio, learn more advanced theory and techniques. Gradually, in a progressive manner, and at your own rate, you will find yourself conducting more advanced multi-tube radio circuits, and doing work like a professional Radio Technician.

Included in the "Edu-Kit" course are 20 Receiver, Transmitter, Code Oscillator, Signal Tracer, Signal Injector, Square Wave Generator and Amplifier circuits. These are not unprofessional "bread board" experiments, but genuine radio circuits, constructed by means of professional wiring and soldering on metal chassis, plus the new method of radio construction known as "Printed Circuitry." These circuits operate on your regular AC or DC house current.

In order to provide a thorough, well-integrated and easily-learned radio course, the "Edu-Kit" includes practical work as well as theory; troubleshooting in addition to construction; training for all, whether your purpose in learning radio be for hobby, business or job; progressively-arranged material, ranging from simple circuits to well-advanced topics in Hi-Fi and TV. Your studies will be further aided by Quiz materials and our well-known FREE Consultation Service.

THE "EDU-KIT" IS COMPLETE

You will receive all parts and instructions necessary to build 20 different radio and electronics circuits, each guaranteed to operate. Our Kits contain tubes, tube sockets, variable electrolytic, mica, ceramic and paper dielectric condensers, resistors, tie strips, coils, hardware, tubing, punched metal chassis, Instruction Manuals, hookup wire, solder, selenium rectifiers, volume controls, switches, knobs, etc.

In addition, you receive Printed Circuit Materials, including Printed Circuit chassis, special tube sockets, hardware and instructions. You also receive a useful set of tools, a professional electric soldering iron, and a self-powered Dynamic Radio & Electronics Tester. The "Edu-Kit" also includes Code Instructions and the Progressive Code Oscillator, in addition to the F.C.C.-type Questions and Answers for the Progressive Signal Tracer and the Progressive Signal Injector, and a High Fidelity Guide and Quiz Book. Everything is yours to keep! "I have repaired several sets for my friends, and made money. The 'Edu-Kit' paid for itself. I was ready to spend \$240 for a Course, but I found your ad and sent for your Kit."

PRINTED CIRCUITRY

At no increase in price, the "Edu-Kit" now includes Printed Circuitry. You build a Printed Circuit Signal Injector, a unique servicing instrument that can detect many Radio and TV troubles. This revolutionary new technique of radio construction is now becoming popular in commercial radio and TV sets.

A Printed Circuit is a special insulated chassis on which has been deposited a conducting material which takes the place of wiring. The various parts are merely plugged in and soldered in terminals.

Printed Circuitry is the basis of modern Automation Electronics. A knowledge of this subject is a necessity today for anyone interested in Electronics.

UNCONDITIONAL MONEY-BACK GUARANTEE

ORDER FROM AD - RECEIVE FREE BONUS
RADIO & TV PARTS JACKPOT WORTH \$15

- Send "Edu-Kit" Postpaid. I enclose full payment of \$26.95.
- Send "Edu-Kit" C.O.D. I will pay \$26.95 plus postage.
- Send me FREE additional information describing "Edu-Kit."

Name.....
Address.....

Progressive "EDU-KITS" Inc. 1185 Broadway, Dept. 247-G
Hewlett, N. Y. 11557
(ATT: S. GOODMAN, M.S. in ED., PRES.)

Circle 118 on reader's service card

NOTEWORTHY CIRCUITS

10-TURN POT IS HEART OF LCR BRIDGE

Here is a very good way to make bridge measurements of resistors, capacitors and inductors. It is relatively inexpensive and accurate, and requires only simple calculation.

You need a 10-turn precision potentiometer of whatever accuracy you decide on, a 10-turn dial to fit it, five binding posts and an ac and dc null detector, sensitivity depending on your needs. The more sensitive the detector, the more accurate the measurement. It can be an ac or dc vtvm, an oscilloscope, a galvanometer or even a headset. The voltage source can suit your needs also, from dc to variable-frequency ac. You will also need a few standards, depending on the ranges you want to measure—1% resistors and capacitors in multiples of 10 are convenient.

The bridge measures by a ratio technique. The 10-turn pot is the ratio

arm. We know that the bridge is balanced when the conditions of Fig. 1 are fulfilled. In the practical circuit (Fig. 2) A equals the reading R, and B equals 1 - R; so, on our bridge, a null occurs when

$$\frac{S}{X} = \frac{R}{1-R} \quad X = S \left(\frac{1-R}{R} \right)$$

You can see that you don't need to know the value of the 10-turn pot—only the ratio of the two sections, as read from the dial. (A little extra work and a lot of time will give you a table

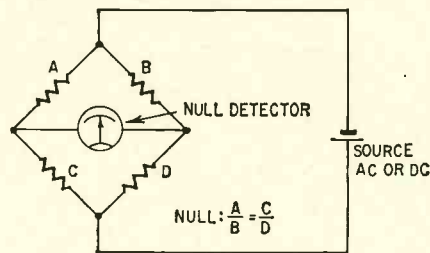

Fig. 1

of values for the ratio (1 - R)/R if you care to calculate them. Better, write down the values you get as you use the bridge and eventually you will have a table. This will speed your measurements considerably.)

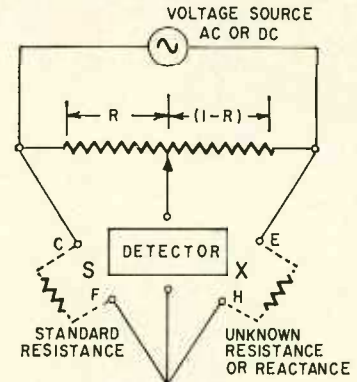

Fig. 2

To calibrate the ratio arms initially, connect two identical 1% resistors, one to the S terminals and the other to the X terminals (Fig. 2). Adjust the pot for a null, then set the dial to read 5 (assuming you have a dial marked 0 to 10) or in any case, to the halfway mark, whatever it is on your dial. This sets the ratio arms, and, since a good 10-turn pot is very linear, no further calibration is needed.

MOVING DATE EXTENDED—SALE CONTINUES

FREE \$1 BUY WITH EVERY 10 YOU ORDER

Only applies to "\$1" Buys

FREE GIFT WITH EVERY ORDER

- | | | | |
|---|--|---|--|
| <input type="checkbox"/> 300—ASST. 1/2 W RESISTORS Top Brand, Short leads, excellent \$1 | <input type="checkbox"/> 100—ASST 1/4 WATT RESISTORS stand. choice ohmages, some in 5% \$1 | <input type="checkbox"/> \$50 STARLINE AM-FM RADIO \$12 complete needs slight adjustment | <input type="checkbox"/> 4—SHOCK-PROOF SCREWDRIVERS 4", 4 1/2", 5" and Phillips blades \$1 |
| <input type="checkbox"/> 100—MOLDED TUBULAR COND. Top brand, short leads, excellent \$1 | <input type="checkbox"/> 100—ASST 1/2 WATT RESISTORS stand. choice ohmages, some in 5% \$1 | <input type="checkbox"/> 20 — ASSORTED TUBES Radio, Television and Industrial .. \$1 | <input type="checkbox"/> 50 ASSORTED MYLAR CONDENSERS Popular types .001 to .47 .. \$1 |
| <input type="checkbox"/> 50—ASSORTED #3AG FUSES Popular assorted ampere ratings .. \$1 | <input type="checkbox"/> 70—ASST 1 WATT RESISTORS stand. choice ohmages, some in 5% \$1 | <input type="checkbox"/> FATHOM DEPTH PIECE OF EQUIPMENT loaded with fine parts \$1 | <input type="checkbox"/> 20 — EXPERIMENTER'S COIL "JACKPOT" assorted for 101 uses \$1 |
| <input type="checkbox"/> 5—I.F. COIL TRANSFORMERS sub-min for Transistor Radios .. \$1 | <input type="checkbox"/> 35—ASST 2 WATT RESISTORS stand. choice ohmages, some in 5% \$1 | <input type="checkbox"/> ALL AMERICAN TUBE KIT Top Standard Brand — 12BA6, 12BE6, 12AV6, 50C5, 35W4 .. \$2 | <input type="checkbox"/> 10—ASSORTED DIODE CRYSTALS 1N34, 1N48, 1N60, 1N64, 1N82 \$1 |
| <input type="checkbox"/> 5 — AUDIO OUTPUT TRANSFORMER sub-min for Trans Radios \$1 | <input type="checkbox"/> 50—PRECISION RESISTORS asst. list-price \$50 less 98% .. \$1 | <input type="checkbox"/> 3 — TOP BRAND 35W4 TUBES \$1 | <input type="checkbox"/> 10—SNAP HOOK & CABLE RIG for boat, car, handy for 101 uses \$1 |
| <input type="checkbox"/> 4—TOGGLE SWITCHES SPST, SPDT, DPST, DPDT .. \$1 | <input type="checkbox"/> 20 — ASS'TED WIREWOUND RESISTORS, 5, 10, 20 watt .. \$1 | <input type="checkbox"/> 10—SYLVANIA 1U4 TUBES brand new Jan., individual cartons also serves as IT4 .. \$1 | <input type="checkbox"/> 20—ITT SELENIUM RECTIFIERS \$65ma for Radios, Meters, Chargers, Transistors, Experiments, etc. \$1 |
| <input type="checkbox"/> 15—ASST. ROTARY SWITCHES all popular types \$20 value .. \$1 | <input type="checkbox"/> 50—ASST. CERAMIC CONDENSERS some in 5% .. \$1 | <input type="checkbox"/> 25 — SYLVANIA HEAT SINKS for Transistors, etc. \$1 | <input type="checkbox"/> 2—G.E. PIECES OF EQUIPMENT \$1 stacked with over 200 useful parts |
| <input type="checkbox"/> CLEAN UP THE KITCHEN "JACKPOT" Big Deal only one to a customer .. \$1 | <input type="checkbox"/> 50—ASST. TERMINAL STRIPS all types, 1-lug to 6-lug .. \$1 | <input type="checkbox"/> 100—MIXED DEAL "JACKPOT" Condensers, Resistors, Surprises .. \$1 | <input type="checkbox"/> 20—G-E #NE-2 TUBES Neon Glow Lamp for 101 uses .. \$1 |
| <input type="checkbox"/> 50—RADIO & TV SOCKETS all type 7 pin, 8 pin, 9 pin, etc. \$1 | <input type="checkbox"/> 25 — INSTRUMENT POINTER KNOBS selected popular types .. \$1 | <input type="checkbox"/> 100—BRASS FAHNSTOCK CLIPS popular type & size, plated .. \$1 | <input type="checkbox"/> G.E. TV POWER TRANSFORMER \$4 250ma, 360/360v, 6.3-9A, 5v-3A |
| <input type="checkbox"/> 2 — UNIVERSAL 2 1/4" PM SPEAKERS for Radios, Intercom, as multiple Speakers, etc. \$1 | <input type="checkbox"/> 50—ASST. RADIO KNOBS all selected popular types .. \$1 | <input type="checkbox"/> \$15.00 RADIO PARTS "JACKPOT" handy assortment .. \$1 | <input type="checkbox"/> 3—ASST WEBSTER CARTRIDGES best types, complete with sapphires \$1 |
| <input type="checkbox"/> UNIVERSAL 5" PM SPEAKER Alnico 5 magnet, quality tone .. \$1 | <input type="checkbox"/> 50—RCA LUCITE RADIO KNOBS popular type w. Indicator pointer \$1 | <input type="checkbox"/> 3 — ELECTROLYTIC CONDENSERS 50/30-150v .. \$1 | <input type="checkbox"/> RONETTE SAPPHIRE CARTRIDGE dual flipover type—value \$5 .. \$1 |
| <input type="checkbox"/> UNIVERSAL 4" PM SPEAKER Alnico 5 magnet, quality tone .. \$1 | <input type="checkbox"/> 5 — 50K VOLUME CONTROLS less switch .. \$1 | <input type="checkbox"/> 50 — RMC DISC CERAMIC COND your choice 25, 50, 100 1K, 5K, 10K mfs (or assorted) \$1 | <input type="checkbox"/> RONETTE STEREO CARTRIDGE latest dual sapphire flipover type .. \$2 |
| <input type="checkbox"/> UNIVERSAL 4" PM TWEETER SPEAKER for FM, HI-FI, etc. \$1 | <input type="checkbox"/> 10—DUAL CONTROLS 350-1 meg, long shaft, 101 uses \$1 | <input type="checkbox"/> 3 AMPHENOL CO-AX CONNECTORS SO-239, PL-259, M-359 or asst \$1 | <input type="checkbox"/> SONOTONE CARTRIDGE No. 2T \$2 |
| <input type="checkbox"/> 25—2 TERMINAL PIN JACKS asst types for various uses .. \$1 | <input type="checkbox"/> 2—LOOPSTICK ANTENNAS hi-gain, ferrite, adjustable .. \$1 | <input type="checkbox"/> 2—POWER TRANSISTORS No. 1 Replace 2N155, 2N176, 2N301, etc. \$1 | <input type="checkbox"/> SONOTONE CARTRIDGE No. 3T \$3 |
| <input type="checkbox"/> 10—SPEAKER PLUG SETS deluxe type, 2 conductor, wired \$1 | <input type="checkbox"/> 5—PNP TRANSISTORS general purpose, TO-5 case \$1 | <input type="checkbox"/> 50—BALL POINT PENS Retractable, assorted colors .. \$1 | <input type="checkbox"/> SONOTONE CARTRIDGE No. 8T \$3 |
| <input type="checkbox"/> 3 — AUDIO OUTPUT TRANSFORMERS 50L6 type .. \$1 | <input type="checkbox"/> 5—NPN TRANSISTORS general purpose, TO-5 case .. \$1 | <input type="checkbox"/> 20 — ADJUSTABLE ANTENNA MAST BAND CLAMPS with STAND-OFFS .. \$1 | <input type="checkbox"/> 3—SAPPHIRE STYLUS NEEDLES Ronette type for most cartridges .. \$1 |
| <input type="checkbox"/> 3 — AUDIO OUTPUT TRANSFORMERS 6K6, 6V6 .. \$1 | <input type="checkbox"/> 20—PENLITE BATTERIES 1 1/2v \$1 | <input type="checkbox"/> 8—ASST. LUCITE CASES hinged cover, handy for parts .. \$1 | <input type="checkbox"/> 3—STANDARD SAPPHIRE NEEDLES for all thumbscrew cartridges \$1 |
| <input type="checkbox"/> 3—AUDIO OUTPUT TRANSFORMERS 3V4, 3Q4, 3S4 .. \$1 | <input type="checkbox"/> 15—BATTERIES C-cell similar 935 .. \$1 | <input type="checkbox"/> ELECTROSTATIC 3" TWEETER SPEAKER for FM, HI-FI, etc. \$1 | <input type="checkbox"/> 2—SONOTONE NEEDLES No. 2T \$1 |
| | <input type="checkbox"/> 10—BATTERIES D-cell similar 950 .. \$1 | | |

BROOKS RADIO & TV CORP., 84 Vesey St., Dept. A, New York 7, N.Y. TELEPHONE COrtlandt 7-2359

Be sure you don't apply excessive power to the pot or the standards. That might happen when the ratio is large—that is, when the movable contact of the pot is near one end. All you need do is interchange the source and the detector.—*Marvin P. Willoughby*

SIMPLE SIGNAL-POWERED SQUARE-WAVE ADAPTER

It is often convenient to have an adapter for converting sine-wave oscillator output to square waves, especially an adapter that requires no external power supply.

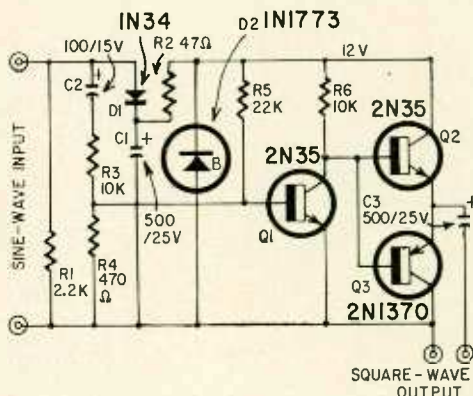

This circuit rectifies a small amount of the incoming signal with D1,

R1 and C1, and uses the resulting dc to power the transistors. The Zener diode regulation of R2 and D2 is optional, and may be omitted if saturation and overvoltage protection are not needed.

Transistor Q1 is an amplifier and drives Q2 and Q3, which form a complementary single-ended push-pull emitter follower. The input is divided by R3 and R4 to provide the right amount of drive.

An input signal of 15 volts rms is enough to give a square-wave output of 10 volts peak to peak, at frequencies from 25 cycles to 25 kc.—*Donald H. Rogers*

SELF-BALANCING OUTPUT CIRCUIT

Unbalanced cathode currents in a push-pull output stage tend to produce second-harmonic distortion, reduce the amount of negative feedback at low frequencies and, if great enough, will reduce the amplifier's overload point. Matched-pair output tubes drift apart with age. Manual balancing circuits that equalize cathode currents by adjusting individual biases are popular but require frequent readjustment.

The diagram shows a self-balancing arrangement known as "Blumlein's Garter." It is an old circuit revived by

BIG CATALOG

World's "BEST BUYS"
in GOV'T. SURPLUS
Electronic Equipment

FULL OF TOP QUALITY ITEMS—

Transmitters, Receivers, Power Supplies, Inverters, Microphones, Filters, Meters, Cable, Keyers, Phones, Antennas, Chokes, Dynamotors, Blowers, Switches, Test Equipment, Headsets, Amplifiers, etc., etc. SEND 25¢ (stamps or coin) for CATALOG and receive 50¢ CREDIT on your order. Address Dept. RE.

FAIR RADIO SALES

P. O. Box 1105 • LIMA, OHIO • 45802

COMPONENT CURVE TRACER

If you're like most experimenters, you have boxes full of parts you can't use because you don't know their value or rating, or even whether they're any good. This quickly built box adapts your scope to check any common electronic part: diodes, transistors, SCR's, resistors, capacitors, inductors.

COMING IN NOVEMBER RADIO-ELECTRONICS

- | | | | |
|--|---|--|--|
| <ul style="list-style-type: none"> <input type="checkbox"/> CHAPT ZU DI MITZIA "JACKPOT" double your money back if not completely satisfied \$1 <input type="checkbox"/> 1000—ASST. HARDWARE KIT screws, nuts, washers, Rivets, etc. \$1 <input type="checkbox"/> 250—ASST. SOLDERING LUGS best types and sizes \$1 <input type="checkbox"/> 250—ASST. WOOD SCREWS finest popular selection \$1 <input type="checkbox"/> 250 — ASST. SELF TAPPING SCREWS #0, #8, etc. \$1 <input type="checkbox"/> 150—ASST. 6/32 SCREWS and 150 6/32 HEX NUTS \$1 <input type="checkbox"/> 150—ASST. 8/32 SCREWS and 150 8/32 HEX NUTS \$1 <input type="checkbox"/> 150—6/32 HEX NUTS and 150—8/32 HEX NUTS \$1 <input type="checkbox"/> 150—ASST. 2/56 SCREWS and 150—2/56 HEX NUTS \$1 <input type="checkbox"/> 150—ASST. 4/40 SCREWS and 150—4/40 HEX NUTS \$1 <input type="checkbox"/> 150—ASST. 5/40 SCREWS and 150—5/40 HEX NUTS \$1 <input type="checkbox"/> 500—ASSORTED RIVETS most useful selected sizes \$1 <input type="checkbox"/> 500—ASSORTED WASHERS most useful selected sizes \$1 <input type="checkbox"/> 100 — ASST. RUBBER & FELT FEET FOR CABINETS best sizes \$1 <input type="checkbox"/> 10—ASSORTED SLIDE SWITCHES SPST, SPDT, DPDT, etc. \$1 <input type="checkbox"/> 10 — SURE-GRIP ALLIGATOR CLIPS 2" plated \$1 <input type="checkbox"/> 5—ASSORTED TRANSFORMERS Radio, TV and Industrial \$1 | <ul style="list-style-type: none"> <input type="checkbox"/> 10 SETS — DELUXE PLUGS & JACKS asst. for many purposes ... \$1 <input type="checkbox"/> 10 — SETS PHONO PLUGS & PIN JACKS RCA type \$1 <input type="checkbox"/> 25—DUMONT MOLDED CONDENSERS .1—600v \$1 <input type="checkbox"/> 10—6' ELECTRIC LINE CORDS with plug \$1 <input type="checkbox"/> 4—50' SPOOLS HOOK-UP WIRE 4 different colors \$1 <input type="checkbox"/> 50' — INSULATED SHIELDED WIRE #20 braided metal jacket ... \$1 <input type="checkbox"/> 50' — HI-VOLTAGE WIRE for TV, special circuits, etc. \$1 <input type="checkbox"/> 200'—BUSS WIRE #20 tinned for hookups, special circuits, etc. ... \$1 <input type="checkbox"/> 50 — STRIPS ASSORTED SPAGHETTI handy sizes \$1 <input type="checkbox"/> 100—ASSORTED RUBBER GROMMETS best sizes \$1 <input type="checkbox"/> 50—ASSORTED PRINTED CIRCUIT SOCKETS best types \$1 <input type="checkbox"/> 3—1/2 MEG VOLUME CONTROLS with switch, 3" shaft \$1 <input type="checkbox"/> 5 — ASST. 4 WATT WIRE-WOUND CONTROLS \$1 <input type="checkbox"/> 20—ASSORTED VOLUME CONTROLS less switch \$1 <input type="checkbox"/> 7—ASSORTED VOLUME CONTROLS with switch \$1 <input type="checkbox"/> 15—RADIO OSCILLATOR COILS standard 450kc \$1 <input type="checkbox"/> 20—ASST. PILOT LIGHTS #44, 46, 47, 51, etc. \$1 <input type="checkbox"/> 50 — WHITE TUBE CARTONS asst. for all 4 important sizes \$1 | <h3 style="text-align: center; margin: 0;">TV BARGAIN COLUMN</h3> <ul style="list-style-type: none"> <input type="checkbox"/> STANDARD COLOR TV TUNER \$12 Complete with Tubes \$12 <input type="checkbox"/> 3—MALLORY 80-450V ELECTROLYTIC CONDENSERS (sparkling new) top item for TV and amplifiers \$1 <input type="checkbox"/> STANDARD VHF-UHF TV \$12 TUNER Complete with Tubes ... \$12 <input type="checkbox"/> 10—ASST UHF TUNER STRIPS standard 16 to 67 \$50 value \$1 <input type="checkbox"/> \$15.00 TELEVISION PARTS "JACKPOT" best buy ever \$1 <input type="checkbox"/> 4 — TV ALIGNMENT TOOLS most useful assortment \$1 <input type="checkbox"/> 110° FLYBACK TRANSFORMER for all type TV's incl schematic \$2 <input type="checkbox"/> 110° TV DEFLECTION YOKE for all type TV's incl schematic \$2 <input type="checkbox"/> 90° FLYBACK TRANSFORMER for all type TV's incl schematic \$1 <input type="checkbox"/> 90° TV DEFLECTION YOKE for all type TV's incl schematic \$1 <input type="checkbox"/> 70° FLYBACK TRANSFORMER for all type TV's incl schematic \$1 <input type="checkbox"/> 70° TV DEFLECTION YOKE for all type TV's incl schematic \$1 <input type="checkbox"/> 4—DUMONT VERT OSC TRANS incl schematic for many TV uses \$1 <input type="checkbox"/> 20—ASSORTED TV COILS I.F. video, sound, ratio, etc. \$1 <input type="checkbox"/> 20—ASSORTED TV KNOBS all standard types, \$20 value \$1 <input type="checkbox"/> 20—ASSORTED GRID CAPS for 1B5, 1X2, 6BG6, 6BQ6, etc. \$1 <input type="checkbox"/> 50—ASSORTED TV PEAKING COILS all popular types \$1 | <h3 style="text-align: center; margin: 0;">MARKET SCOOP COLUMN</h3> <ul style="list-style-type: none"> <input type="checkbox"/> TRANSISTOR RADIO asst good, bad, broken, as-is \$1.50 <input type="checkbox"/> 4—TRANSISTOR RADIO EARPIECES wired complete with plug \$1 <input type="checkbox"/> TAPE RECORDER—assorted types good, bad, broken, as-is, potluck \$4 <input type="checkbox"/> STANDARD 1/4W RESISTORS 10% 470, 1500, 6800, 15k, 100k, 2.2 meg, 5meg Your choice 100 for \$1 <input type="checkbox"/> 10—TOP BRAND TRANSISTORS NPN & PNP 2N404, 2N414, 2N696, etc. \$1 <input type="checkbox"/> 25'—MICROPHONE CABLE deluxe, 2 conductor, shielded .. \$1 <input type="checkbox"/> STANDARD TELEPHONE JACK or PLUG make telephone portable .. \$1 <input type="checkbox"/> TELEPHONE RECORDING DEVICE place it under telephone .. \$1 <input type="checkbox"/> CRYSTAL LAPEL MICROPHONE high impedance, 200-6000 cps .. \$1 <input type="checkbox"/> 10 — ASST. RADIO ELECTROLYTIC CONDENSERS \$1 <input type="checkbox"/> 7 — ASST. TV ELECTROLYTIC CONDENSERS popular selection \$1 <input type="checkbox"/> 50 — ASST. TUBULAR CONDENSERS .001 to .47 to 600v .. \$1 <input type="checkbox"/> 20—STANDARD TUBULAR CONDENSERS .047-600v \$1 <input type="checkbox"/> 10—ASST DUAL CONTROLS for Radio, TV, Hi-Fi, Stereo, etc. \$1 <input type="checkbox"/> BONANZA "JACKPOT" not gold, not oil, but a wealth of Electronic Items—Money-Back-guarantee \$5 |
|--|---|--|--|

IMMEDIATE DELIVERY . . . Scientific light packing for safe delivery at minimum cost.
HANDY WAY TO ORDER: Pencil mark or write amounts wanted in each box, place letter F in box for Free \$1 BUY. Enclose with check or money order, add extra for shipping. Tearsheets will be returned as packing slips in your order, plus lists of new offers.

Name Cost of goods
Address Shipping
..... estimated
..... TOTAL

Please specify refund on shipping overpayment desired: CHECK POSTAGE STAMPS MERCHANDISE (our choice) with advantage to customer
Circle 119 on reader's service card

SILICON RECTIFIER SALE

IMMEDIATE DELIVERY
FULLY GTD AMERICAN MADE
NEWEST TYPE FULLY TESTED



750 MA-SILICON "TOPHAT" DIODES

LOW LEAKAGE FULL LEAD LENGTH

PIV/RMS 50/35 .05 ea.	PIV/RMS 100/70 .07 ea.	PIV/RMS 200/140 .10 ea.	PIV/RMS 300/210 .12 ea.
PIV/RMS 400/280 .14 ea.	PIV/RMS 500/350 .19 ea.	PIV/RMS 600/420 .23 ea.	PIV/RMS 700/490 .27 ea.
PIV/RMS 800/560 .35 ea.	PIV/RMS 900/630 .45 ea.	PIV/RMS 1000/700 .60 ea.	PIV/RMS 1100/770 .75 ea.

ALL TESTS AC & DC & FWD & LOAD

SILICON POWER DIODE STUDS				
D.C. AMPS	50 PIV 35 RMS	100 PIV 70 RMS	150 PIV 105 RMS	200 PIV 140 RMS
3	.08 ea.	.12 ea.	.16 ea.	.22 ea.
12	.25	.50	.65	.75
35	.85	1.90	1.25	1.40
50	1.50	1.75	2.20	2.60
100	1.60	2.00	2.40	3.00

SILICON POWER DIODE STUDS				
D.C. AMPS	300 PIV 210 RMS	400 PIV 280 RMS	500 PIV 350 RMS	600 PIV 450 RMS
3	.27 ea.	.29 ea.	.37 ea.	.45 ea.
12	.90	1.30	1.40	1.65
35	2.00	2.35	2.60	3.00
50	3.25	4.00	4.75	6.00
100	3.60	4.50	5.25	7.00

"SCR" SILICON CONTROLLED RECTIFIERS "SCR"						
PRV	7 AMP	16 AMP	25 AMP	7 AMP	16 AMP	25 AMP
25	.30	.50	.85	2.60	1.75	2.15
50	.45	.75	1.00	3.00	2.40	2.75
100	.80	1.25	1.50	4.00	3.20	3.25
150	.90	1.60	2.00	5.00	3.20	3.80
200	1.25	1.80	2.25	6.00	3.40	4.50

SPECIALS! SPECIALS!

100 Different Precision Resistors
1/2-1-2 watt 1/2%-1% TOL \$1.50
2 amp 1000 Piv Silicon Power Rect. .70 ea.
10 for \$6.50

R.C.A. P.N.P. TRANSISTOR

Type 2N406 4 for \$1.00, 100 for \$18.
FACTORY NEW

Computer Grade Condenser 15,500 MFD
15 VDC American Mfg. .75 ea.

Type 1N34 DIODE GLASS .07 ea. 100 for \$5

Money Back guarantee. \$2.00 min. order. Orders
F.O.B. NYC. Include check or money order. Shpg.
charges plus. C.O.D. orders 25% down.

Warren Electronic Components

230 Mercer St., N. Y., N. Y. 10012 • OR 3-2620

Circle 120 on reader's service card

J. S. Murray in an article in *Hi-Fi News* (Croydon, England). There are four resistors in each cathode return. R1 and R4 are the normal cathode biasing resistors. R2 and R3 are added for automatic balancing. Note that the grid resistor of one tube is returned to the junction of the resistors in the other's cathode circuit.

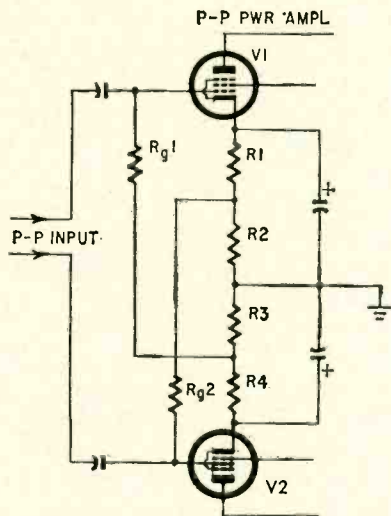

Suppose that V1 has somewhat greater cathode emission and draws more current than V2. The voltage drop across R2 will be greater than that across R3. The cross-connections re-

sult in V1's bias (grid-to-cathode voltage) being greater than V2's. V1's cathode current drops and V2's rises until the currents are very nearly equal. The reduction in unbalance is equal to the ratio of one of the cathode resistors (R1 or R4) to the sum of the four resistors. When the four resistors are equal, current unbalance is one-fourth the value obtained when the same tubes are used with individual biasing resistors or identical amounts of fixed bias.

The cathode time constant must be greater than the grid time constant. The author used 1,000- μ f cathode bypasses for a pair of E184's. By using a suitable choice of time constants as outlined in the patent (British patent No. 886,257) the circuit behaves exactly as with fixed bias without the need for manual balance adjustments.

TRANSISTOR POWER SUPPLY IN BATTERY HYBRID PORTABLE

The Bush ETR82, a three-band portable hybrid receiver, uses an unusual system to supply the screen and plate voltages for the set's one tube, a 1AB6 pentagrid converter. Six D-cells power the transistor part of the circuitry, and a seventh heats the filament of the 1AB6. The blocking oscilla-

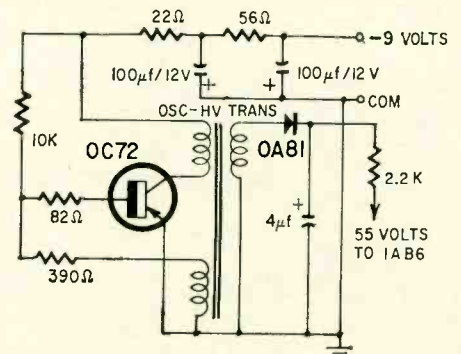

tor, using a 0C72 transistor, develops high-voltage ac which is rectified by the OAB1 diode. The entire converter is housed in a metal tube to keep the oscillator noise from the receiver.—Steve P. Dow
END

STANDARD TV TUNER 41mc

Latest "GUIDED GRID" Compact Model—good for all 41 mc TV's.
All set for parallel—for series change the 6GK5 to a 3GK5.

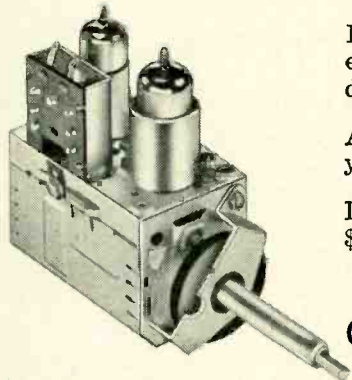

Best TUNER "Standard Kollsman, Inc." ever made—last word for stability, definition & smoothness of operation.

An opportunity—to improve and bring your old TV Receiver up-to-date.

List price \$35—former reduced price \$15.97 — now cut in 1/2 to \$7.95.

L-3", H-4", W-2"

COMPLETE with Tubes & Schematic . . \$7.95

SAME TUNER in Sarkes Tarzian with Tubes & Schematic \$6.95

\$200 HEARING AID—FOR \$5



HEARING AID is a complete Audio Amplifier and includes Tubes, Microphone, Etc.

Top Item for Experiment-er. Can be converted to Inter-Coms, Walkie Talkies, Etc.

5" x 2 1/2" x 1" 1-lb.

Complete as shown incl. Schematic Diagram (less Earphone & Battery) \$5

HOTTEST VALUE EVER

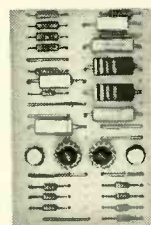

IBM COMPUTER SECTIONS

Each Unit "cost IBM over \$5.00"

6 assorted Units we sell for \$1 are loaded with over 100 valuable parts.

6 for \$1
70 for \$10

Turn Back TO PAGE 98 for Radio-Electronics FREE Reader's Service Page. Special postpaid card will bring you helpful information at no charge.

Please enclose check or money order — only for amount shown, we pay shipping
BROOKS RADIO & TV CORP., 84 Vesey St., New York 7, N.Y.

WHAT'S YOUR EQ?

These are the answers. Puzzles are on page 60.

Which Row?

With the resistors connected as in the diagram, and measuring between A and B, the total resistance is 1,500 ohms

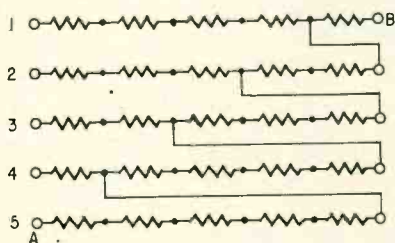

plus 100 times the number of the row containing the 200-ohm resistors.

For example, if the reading is 1,700 ohms, row 2 contains the 200-ohm resistors:

$$1,700 = 1,500 + (100 \times 2).$$

Effective Value?

Remember that the vtvm is made up of a peak detector and a dc amplifier with the scale calibrated to read the rms value of a sinusoidal wave. The vtvm responds to the peak value of the square wave, but will indicate on the scale a value which is 0.707 times the peak value.

$$\text{Scale reading} = \frac{\text{peak value}}{\sqrt{2}} = \frac{10}{\sqrt{2}} = 7.07 \text{ volts.}$$

This is not the effective value of the square-wave source.

Note: The peak, effective and average values of a square wave are equal.

Unbalance

The trouble was obviously in these two 100-ohm resistors, but they were supposedly stable wirewound units! I pulled one (naturally the wrong one), and substituted a new resistor matched to the remaining one. Same trouble. Pulling the other and replacing it with the one originally pulled cured the trouble.

Tests on the faulty resistor revealed that it varied from 101.3 to 103.9 ohms at different times. Apparently it had a few intermittent shorted turns.

WHO IS THE PROFESSIONAL SERVICER?

The *Electron*, the bulletin of the Electronic Guild of Manitoba, recently printed a definition of the professional TV-radio service dealer. It makes good sense.

A professional TV-radio service dealer is a man who has the knowledge necessary to maintain in like-new condition any electronic entertainment de-

vice using vacuum tubes or transistors, hand-wired or printed-board circuitry; and who can do so at a cost which compares favorably with the cost of replacing the device.

To extend the idea of "dealer" as broadly as possible, the definition also covers one who has available regularly the services of a technician who meets those qualifications.

Further, the service dealer must recognize the ever-changing nature of electronic equipment, and must upgrade his technical and business abilities continuously.

He must identify himself properly at his place of business, on all stationery [and in all advertising, we'd like to add].

He must be clean and neat, and treat customers' equipment with proper care.

He must be equipped with sufficient test equipment to be able to service a customer's set in the least possible time.

He must have a place of business easily and safely accessible to the public, located in an area approved by zoning or other requirements of the community, and the place must be maintained so as to show proper care for customers' sets.

He must maintain adequate insurance in all phases of his business so that the customer and his property are not in jeopardy.

END

CRYSTALS are not all the same!



If your dealer is temporarily out of stock or does not carry Texas Crystals, send us his name along with your order. Minimum order, check or C.O.D. is \$5.00. Add 5¢ per crystal for postage, 10¢ for air mail.

Texas Crystals quality is outstanding as evidenced by use in numerous government space projects where there's no compromise with quality, reliability or accuracy. The same dependable performance is yours for CB operation on all 23 channels at only \$2.95 per crystal.



Send for Free Catalog with Circuits

TEXAS CRYSTALS

A Division of Whitehall Electronics Corp.

1000 Crystal Drive Fort Myers, Florida
4117 W. Jefferson Blvd. Los Angeles, California
Phone 813 WE 6-2109 Phone 213 731-2258

DID YOU MISS

the valuable Reader's Service Page?
Turn back to page 98 for free info.

ELECTRONICS



Engineering-Technicians

Bachelor of Science Degree, 30 Months
Save Two Years' Time

- Radio-Television Plus Color Technician (12 Months)
- Electronics Engineering Technology (15 Months)
- Electronics Engineering (B.S. Degree)
 - Electrical Engineering (B.S. Degree)
 - Mechanical Engineering (B.S. Degree)
 - Civil Engineering (B.S. Degree)
 - Architecture (B.S. Degree)

The Nation's increased demand for Engineers, Electronic Technicians, Radio TV Technicians is at an all time high. Heald Graduates are in demand for Preferred High Paying Salaries. Train now for a lucrative satisfying lifetime career.

Approved for Veterans

DAY AND EVENING CLASSES

Write for Catalog and Registration Application. New Term Starting Soon.

HEALD'S

ENGINEERING COLLEGE

Est. 1863—102 Years
Van Ness at Post, RE
San Francisco, Calif.

Your Name
Address
City
State

Circle 122 on reader's service card

FREE

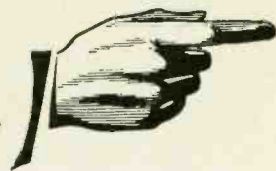

send today for your

ALLIED
1966 CATALOG
world's largest selection

SAVE MOST ON:

*Stereo Hi-Fi
Tape Recording
CB 2-Way Radio
FM-AM & AM Radios
Short Wave Radios
Portable TV • Phonographs
Amateur Gear
Intercoms & P.A.
Automotive Electronics
Test Instruments
TV Tubes & Antennas
Power Tools, Hardware
Parts, Tubes, Transistors*

508 VALUE-PACKED PAGES
*including exclusive products and
special values available only
from* **ALLIED**

MORE OF THE BEST IN ELECTRONICS FOR EVERYONE

EASY TERMS

Use the convenient
Allied Credit Fund Plan
—over 24 months to pay

ALLIED RADIO

The World's Largest Electronic Supply House

*satisfaction
guaranteed or
your money back*

SPECIAL in your FREE 1966 ALLIED CATALOG

see what's new in the wonderful world of **knight-kits**®

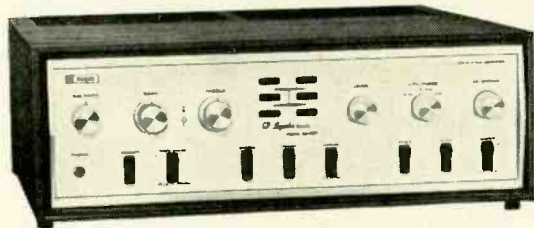

KG-895 Superba Series
120-Watt Solid-State
Stereo Amplifier Kit. \$149.95

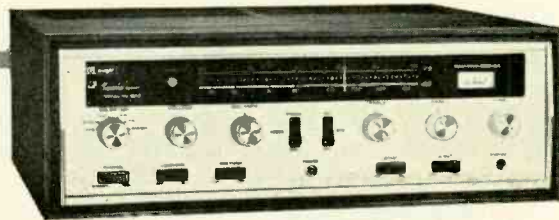

KG-964 Superba
Series 64-Watt Solid-
State FM-AM Stereo
Receiver Kit.
\$189.95

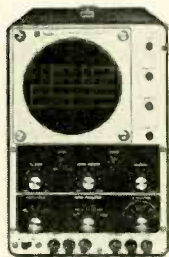

KG-635 5-Inch DC
to 5.2 Mc Wide-
band Oscilloscope
Kit. \$99.95



KG-371 Solid-State
Auto DC Power
Timing Light Kit.
\$19.95

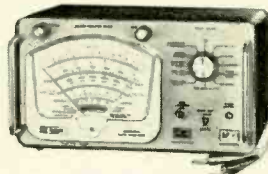

KG-375 Solid-State
Universal Auto Ana-
lyzer Kit. \$49.95



Safari-I Deluxe
23-Channel Citizens
Band Transceiver Kit. \$129.95



C-540 Low-Cost
5-Watt Citizens
Band Transceiver
Kit. \$49.95



KG-221 FM Moni-
tor Receiver Kit
(police, fire, ma-
rine, weather
bands, etc.) \$39.95



KG-201 Solid-State
Motor-Speed/Light
Control Kit. \$9.95

KG-415 Superba
Series Professional
Solid-State Stereo
Tape Deck Kit.
\$249.95



Knight-Kit GUARANTEE: Buy any Knight-Kit. Build it. Operate it. You must be satisfied or we refund your money.

THERE IS A knight-kit FOR EVERY NEED!
easiest to build—enjoy big savings

- Stereo Hi-Fi
- CB 2-Way Radio
- Short-Wave
- Hobby Kits
- Test Equipment
- Automotive
- Intercom
- Amateur Gear

FREE

Send today for your
508-page Allied 1966
value-packed catalog

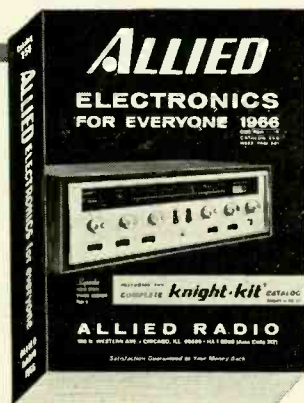

send for your 508-page 1966 Allied Catalog

Free!

ALLIED RADIO, Dept. 2-K
100 N. Western Ave., Chicago, Ill. 60680

Send FREE 1966 Allied Catalog

Name _____
PLEASE PRINT

Address _____

City _____ State _____ Zip _____

ALLIED RADIO

Circle 123 on reader's service card

Radio-Electronics

Test Instrument Issue offers clear, practical, enormously useful guidance on test instruments . . . how they work—and how you can make them work best for you!



Now discover the valuable ideas coming your way in Radio-Electronics big TEST INSTRUMENT ISSUE. You'll receive a unique step-by-step guide to the OSCILLOSCOPE, showing newest uses, applications and techniques. You'll see how to make specific tests and measurements and learn how to interpret patterns. In addition, you'll find a complete buyer's guide to SIGNAL GENERATORS, covering all types used in radio, TV, FM, AM and audio. Here's the kind of issue you'll refer to again and again to check important facts and develop new ideas.

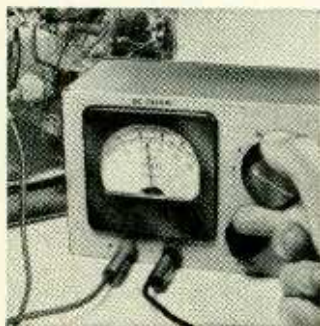

Other eye-opening features include the special report on CALIBRATION AND MAINTENANCE with its practical know-how on keeping your equipment accurate and in perfect working condition. USING AND ABUSING YOUR METERS highlights what to do and what not to do with service and lab equipment. THE SHOP AS A SERVICE TOOL reveals the secrets of operating a first-rate servicing center that provides most-wanted electronic assistance. *It all adds up to "must" reading*, when you remember that you get complete test instrument guidance . . .

plus valuable reports on audio, radio, electronics and television in November Radio-Electronics

available October 19th at your
favorite newsstands and electronics parts jobbers!

NEW BOOKS

ABBOT'S NATIONAL ELECTRICAL CODE HANDBOOK (11th Ed.), revised by Frank Stetka. McGraw-Hill Book Co., 330 W. 42 St., New York, N.Y. 10036. 5½ x 8¼ in., 688 pp. Cloth, \$12.50

Based on the 1962 National Electrical Code, this edition includes the provisions for 3-conductor plugs and receptacles, and new requirements in regard to fuses, as well as material on aluminum sheathed and metal-clad cable, swimming pools, etc.

UNDERSTANDING LASERS AND MASERS, by Stanley Leinwoll. John F. Rider Publisher, Inc., 116 W. 14 St., New York, N.Y. 10011. 6 x 9 in., 88 pp. Paper, \$1.95

Possibly the clearest book on the subject yet written. Explanations are made simpler with numerous drawings, many of them apparently original.

ESSENTIALS OF ELECTRICITY-ELECTRONICS (3rd Edition), by Morris Slurzberg and William Osterheld. McGraw-Hill Book Co., 330 W. 42 St., New York, N. Y. 10036. 6 x 9 in., 660 pp. Cloth, \$7.50

The third edition of the excellent *Essentials of Electricity*, published in 1954. This book is especially useful to the practical technician who wishes to advance himself without going beyond ordinary arithmetic. The authors show him, not only how various components and circuits work, but how to calculate for exact effect on the system they work in.

FUNDAMENTALS OF ELECTRONICS (2nd Edition), by Matthew Mandl. Prentice-Hall, Inc., Englewood Cliffs, N.J. 6 x 9 in., 386 pp. Cloth, \$14.60

A practical study of basic circuits and devices, with examples and problems. Practical applications are discussed, including receivers, test instruments, transducers and gating. Semiconductors are covered thoroughly.

HANDBOOK OF ALGEBRAIC & TRIGONOMETRIC FUNCTIONS, by Allan Lytel. Howard W. Sams & Co., Inc., 4300 W. 62 St., Indianapolis 6, Ind. 5½ x 8½ in., 160 pp., Paper, \$2.95

Common and natural logs, powers and roots, conversions and math formulas in convenient form.

SIMPLIFIED MODERN FILTER DESIGN, by Philip R. Geffe. John F. Rider Publisher, 116 W. 14 St., New York, N.Y. 10011. 5¾ x 8¾ in., 182 pp. Cloth, \$8.75

Intended to help the engineer with some knowledge of filters to reduce the work necessary in designing low-pass, band-pass, high-pass or band-stop filters. Also contains information on attenuation equalizers, linear-phase filters and delay equalizers.

END

SCHOOL DIRECTORY

Learn Electronics for your
SPACE-AGE EDUCATION
at the center of
America's aerospace industry

No matter what your aerospace goal, you can get your training at Northrop Tech, in sunny Southern California.

COLLEGE OF ENGINEERING. Get your B.S. degree in engineering in just 36 months by attending classes year round. Most Northrop Tech graduates have a job waiting for them the day they're graduated!

A & P SCHOOL. Practical experience on real aircraft. One-year course prepares you for F. A. A. A & P certificate. **WRITE TODAY FOR CATALOG.**

NORTHROP INSTITUTE OF TECHNOLOGY
1199 W. Arbor Vitae, Inglewood, Calif.



A JOB or a POSITION ?

The difference is **ELECTRONIC MATHEMATICS**

NOW! A NEW WAY TO LEARN—I. H. S. I. WAY. A complete home study course in electronic math to help you get the position you want—**MORE MONEY—MORE RESPECT.**

COURSE PREPARED BY COLLEGE PROFESSORS who have lectured to thousands of men on math and engineering. You learn at home quickly, easily—**AS FAST** as you want.

YOU SIGN NO CONTRACTS Pay only if satisfied—you owe it to yourself to examine the **INDIANA HOME STUDY INSTITUTE COURSE IN ELECTRONIC MATH.** **FREE BONUS**—if you join now, a refresher course in basic arithmetic.

Write for Brochure—No Obligation
THE INDIANA HOME STUDY INSTITUTE
Dept. RE-10, P.O. Box 1189
Panama City, Fla. 32402

EARN Electronics Engineering DEGREE

You can earn an A.S.E.E. degree at home. College level **HOME STUDY** courses taught so you can understand them. Continue your education, earn more in the highly paid electronics industry. Missiles, computers, transistors, automation, complete electronics. Over 27,000 graduates now employed. Resident school available at our Chicago campus—Founded 1934. Send for free catalog.

American Institute of Engineering & Technology
1139 West Fullerton Parkway, Chicago 14, Ill.

LEARN ELECTRONICS

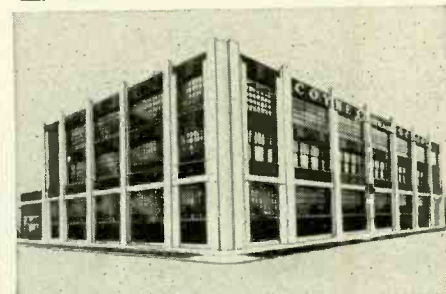

FOUNDED 1899

NOT-FOR-PROFIT

COYNE ELECTRONICS INSTITUTE

Electronics Engineering Technology	—	Degree (2 Yrs.)
Electrical-Electronics Technician	—	Diploma (40 Wks.)
TV-Radio-Electronics Technician	—	Diploma (40 Wks.)
Combined Electronics Technician	—	Diploma (80 Wks.)
Practical Electrical Maintenance	—	Diploma (32 Wks.)
Practical Refrigeration Air Conditioning and Appliance Repair	—	Diploma (24 Wks.)
Specialized Industrial Electronics	—	Diploma (16 Wks.)
Introduction to Electricity-Electronics	—	Certificate (8 Wks.)
FCC First Class Radiotelephone	—	Certificate (100 Hrs.)

Special finance plans. Part time employment service while in school. Also Free graduate employment service.



Use this coupon to get our **FREE BOOK**

"YOUR OPPORTUNITIES IN ELECTRONICS"

COYNE ELECTRONICS INSTITUTE, Dept. of Electronics 75-N
1501 W. Congress Parkway, Chicago, Illinois 60607

Name _____ Age _____

Address _____ Phone _____

City _____ Zone _____ State _____

Unlike most other schools, we do not employ salesmen

Circle 124 on reader's service card

B.S. degree in 36 months

Small professionally-oriented college. Four-quarter year permits degree completion in three years. Summer attendance optional. **Engineering:** Electrical (electronics or power option), Mechanical, Civil, Chemical, Aeronautical. **Business Administration:** Accounting, General Business, Motor Transport Administration. One-year Drafting and Design Certificate program. Graduate placement outstanding. Founded 1884. Rich heritage. Excellent faculty. Small classes. Well-equipped labs. New library. New residence halls. Attractive 300-acre campus. *Modest costs.* Enter Jan., March, June, Sept. *For Catalog and View Book, write Director of Admissions.*



TRI-STATE COLLEGE

24105 College Avenue, Angola, Indiana

GET INTO ELECTRONICS

V.T.I. training leads to success as technicians, field engineers, specialists in communications, guided missiles, computers, radar and automation. Basic & advanced courses in theory & laboratory. Electronic Engineering Technology and Electronic Technology curricula both available. Assoc. degree in 29 mos. B.S. also obtainable. G.I. approved. Graduates in all branches of electronics with major companies. Start Sept., Feb. Dorms, campus. High school graduate or equivalent. Catalog.

VALPARAISO TECHNICAL INSTITUTE
Department C, Valparaiso, Indiana



when it's time to think of college you should read this

FREE CAREER BOOKLET

about electronics at

MSOE



MILWAUKEE SCHOOL OF ENGINEERING

MS-237
Dept. RE-1065, 1025 N. Milwaukee Street
Milwaukee, Wisconsin 53201

Tell me about an engineering career through residence study in:

Electrical fields Mechanical fields

Name _____ Age _____

Address _____

City, State _____

ELECTRONICS

Train with Specialists. Qualify in minimum time for a professional career. Earn B.S.E.E. degree in 30 mos. Assoc. in Engr in 18 mos. Small classes. Industry oriented faculty. Also 1-yr Electronic Tech. course. Nationwide job placement. Request Cat. H.

NORTHRIDGE TECHNICAL COLLEGE
Northridge, Calif. (In the San Fernando Valley)

Military surplus radios ARC-27 ARC-34 ARC-38 ARC-39 ARC-44 ARC-52 ARC-55 ARC-73 ARC-84 R-220C/ARN-21 51X-2/17L-7 RT-68/GRC, Test sets with ARM, URM, UPM, SG prefixes, Top cash dollar paid. SLEP ELECTRONICS, Drawer 178 Ellenton, Florida. 33532

TV SETS WANTED as is any quantity. TV, 467 Columbus Avenue, New York, N. Y.

WANTED—Western Electric 756A Speaker. ALICE LAWSON, 1640 W. Mulberry, Phoenix, Arizona. 85015

WANTED: Latest "RCA" 8-lesson color Television Course, complete, with questions and answers. ALFORD N. LALUM, Brinsmade, N. Dak. 58320

ELECTRONIC TECHNICIANS CATV-MICROWAVE. Barnard and Associates, consulting communications engineers, due to the rapid growth of CATV, has available permanent positions in Microwave Path Loss Testing and CATV Field Strength Measurement Testing. Applicants must have a first or second class radio telephone FCC License. High school graduate with technical school or some college preferred. Single. Must be willing to travel continuously. Send complete resume to: J. C. BARNARD AND ASSOCIATES, 10121 Manchester Road, St. Louis, Missouri 63122 (314) YO 6-2116

SERVICES

METERS—MULTIMETERS REPAIRED and calibrated. BIGELOW ELECTRONICS, Box 71-B, Bluffton, Ohio.

TRANSISTORIZED products dealers catalog, \$1. INTERMARKET, CPO 1717, Tokyo, Japan.

NAMEPLATES, Decals, Signs, Plaques, Trophies, Badges. Write R. E. SETON, New Haven 15, Conn.

METERS REPAIRED, VTVM, VOM. 90 Day Warranty. TV TUNER SERVICE, Box 793 E, Twin Falls, Idaho.

NEED MONEY? Borrow \$100-\$1000 by mail. Confidential, repay in 24 months. Free loan application. BUDGET FINANCE CO., DEPT. PB-215, 317 So. 20th, Omaha, Nebraska. 68102

AUDIO—HI-FI

COMPONENT QUOTATIONS—tapes Mylar 1800' postpaid \$1.59 each. BAYLA, Box 131RE Waukegan, N.Y.

WRITE for highest discounts on components, recorders, tapes, from franchised distributors. Send for FREE monthly specials. CARSTON, 1686-R Second Ave. N.Y.C. 10028

RENT STEREO TAPES—over 2,500 different—all major labels—free brochure. STEREO-PARTI, 1616 Terrace Way, Santa Rosa, Calif.

STEREO TAPES. Save up to 60% (no membership fees). We discount recorders, batteries, accessories, and mail pre-recorded tape prepaid anywhere that United States rates prevail. Free 60 page catalog. SAXITONE, 1776 Columbia Road N.W., Washington, D.C. 20009

TAPE recorders, Hi-Fi components, Sleep-learning equipment, Tapes, Unusual values. Free catalog. DRESSNER, 1523 Jericho Turnpike, New Hyde Park 5, N.Y.

HI-FI COMPONENTS, Tape Recorders, at guaranteed "WE will not be undersold" prices. 15-day moneyback guarantee. Two-year warranty. NO Catalog. Quotations Free. HI-FIDELITY CENTER, 1797 (R) 1st Ave., New York, N.Y. 10028

TAPE RECORDER SALE. Brand new, latest models, \$10.00 above cost. ARKAY SALES, 1028-E Commonwealth Ave., Boston, Mass. 02215.

LOW LOW QUOTES, DYNA. A.R. GARRARD E.V. HI-FI, Roslyn, Pa. 19001

HI-FIDELITY COMPONENTS, Ham Marine and Communication equipment at considerable savings. If you want to save money write us for our low prices on all your needs. AIREX RADIO CORP., 85 (RE) Cortlandt St., N.Y., N.Y. 10007

LOW LOW QUOTES, stereo... Components... recorders send 10¢ Dept. R, 901 8th, Rapid City, S. Dak. 57701

STEREO TAPE RENTALS for discriminating listeners. GOLD COAST TAPE LIBRARY, Box 2262-Palm Village, Hialeah, Florida. 33012

BUSINESS OPPORTUNITIES

PIANO Tuning learned quickly at home. Tremendous field! Musical knowledge unnecessary. Information free. EMPIRE SCHOOL OF PIANO TUNING, Dep't. RE Box 327, Shenandoah Station, Miami, Florida 33145. (Founded 1935.)

New scientific transistor instrument detects buried coins, treasures. Will detect gold, silver, copper, iron, etc. \$19.95 up. Free catalog. RELCO-A-25, Box 10563, Houston 18, Texas.

BUSINESS AIDS

JUST STARTING IN TV SERVICE? Write for FREE 32 PAGE CATALOG of Service Order books, invoices, job tickets, phone message books, statements and file systems. OELRICH PUBLICATIONS, 6556 W. Higgins, Chicago, Ill. 60656.

1,000 Business Cards, "Raised Letters" \$3.95 postpaid. Samples. ROUTH RE12, 2633 Randleman, Greensboro, N.C. 27406.

NEW PUBLICATION. "Green Dollar Gold Mines." Professional business secrets for success and profits in radio and TV repairing. \$5.95. UNITED PRODUCTS CO., 922 W. Grove Street, Bloomington, Illinois. 61701

Rectifiers & Transistors

750 Ma-Silicon Diodes "Epoxy" or "Top Hat"					
PIV	PIV	PIV	PIV	PIV	PIV
50	5¢	300	12¢	600	21¢
100	7¢	400	14¢	700	25¢
200	10¢	500	18¢	800	32¢
				900	40¢
				1000	55¢
				1100	70¢

Full Leads, All tests, Guaranteed. American made

Silicon Power Diode Studs					
Amps	50 PIV	100 PIV	150 PIV	200 PIV	
3	8¢	14¢	16¢	22¢	
15	25¢	50¢	65¢	75¢	
18	18¢	40¢	60¢	70¢	
35	60	80	1.15	1.30	

Amps	300 PIV	400 PIV	500 PIV	600 PIV	
3	25¢	28¢	35¢	40¢	
15	90	1.30	1.40	1.65	
18	85	1.25	1.35	1.60	
35	1.90	2.25	2.50	2.90	

*Press Fit Package for Alternators
 10 Watt Sil. Zener Stud 12-200v. 95¢ ea.
 1 Watt Zener diode, axial leads 6v-200v 50¢ ea.
 Sil. diode Stud, 1500 PIV, 300ma 50¢ ea.
 Sil. diode, 1500 PIV, 50ma, axial leads 35¢ ea.
 Hi-Voltage-Silicon epoxy diode, 2 1/2" x 3/8" x 1/2"
 Hoffman—3000 PIV-200ma \$1.49 ea.
 Hoffman—6000 PIV-200ma \$3.49 ea.
 Thermistor, bead, 900 or 1200 ohms, 600°F, 2/\$1.00

20 Watt Germanium (internal & external heat sink)

2N1038 28¢	2N1042 35¢
2N1039 35¢	2N1043 45¢
2N1040 45¢	2N1044 60¢
2N1041 60¢	2N1045 80¢

Silicon Power Transistors, 85 w, 2N1724 \$1.50
 Philco Sil., NPN, 2N2479, new 3 for \$1.00
 HF Silicon, 2N702, 100 mc 40¢; 2N703-150 mc 60¢

Light Sensitive Resistor

75 ohms—10 meg, 100 volts, 150maw . . . \$1.75 ea.

Sil. diodes, 1N200 series, ass't'd., new 15 for \$1.00
 Ger. diodes, glass, new, exceeds 1N34 15 for \$1.00
 Nickel-Cadmium Battery, 9 1/2 oz., 8 amp-hr. \$1.95

Varicap-Voltage Variable Capacitor

47 pf at 4v., 4:1, new \$1.25 ea.

Silicon Controlled Rectifiers

PRV	7 amp.	16 amp.	PRV	7 amp.	16 amp.
25	28	48	200	1.05	1.70
50	48	70	300	1.60	2.20
100	70	1.20	400	2.10	2.70
150	80	1.50	500	2.80	3.30
			600	3.00	3.90

All Tests Stud Type 600 3.00 3.90
 Money back guarantee. \$2.00 min. order, include postage. Catalog 25¢.

Electronic Components Co.
 Box 2902B Baton Rouge, La. 70821

Circle 126 on reader's service card

CAN YOU SAVE MONEY ON PARTS?

Now You Can. Just Write for Edlie's

FREE MONEY-SAVING CATALOGUE

Write to: EDLIE ELECTRONICS INC.

154 Greenwich St. Dept. RE-3,
 New York 6, N. Y.

Listed below are just a few of the many

BARGAINS

4 TUBE STEREO AMPLIFIER

A new and completely working 2 channel unit, suitable for use with a record changer, tape recorder, etc. Operates from a 115 volt AC or DC source. Contains 3 output transformers, 3-35EM5 and 1 - ECC83 tubes, and 1 top hat silicon rectifier. 2 single and 1 dual control, and all related components. Housed on a chassis 5 1/4"x6 3/4"x1" high. Weight 2 1/2 lbs.



Price \$6.95

TRANSFORMER POWERED, 4-TUBE STEREO AMPLIFIER

A dual channel amplifier, 5 watts each channel. Operates from a 115 volt, 60 cycle source. Contains 2-6BQ5, 1 - 6V3, and 1 - 12AX7 tubes, and power transformer. 1 - 4 section electrolytic condenser, 2 - 8 watt 6BQ5 output transformers, 3 dual & 1 single volume controls, mounted on a chassis 3 1/2"x1 1/2"x2 3/4" high. Weight 5 lbs.



Price \$9.85

AM-FM FRONT END

Consists of a slug tuned FM assembly which includes all r.f. coils, trimmers and condensers, and also a 2-gang AM variable condenser to provide a tuning range of 88 to 108 M. C. and 550 to 1600 KC. Completely wired and pretuned. Complete with a 120T8 tube.

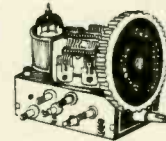

Price \$2.95

Dynamic Microphone

Made by a leading U.S. manufacturer. Push to talk, noise cancelling, with coiled 3 wire cable 5'-0" when extended; fitted with a 5 prong amphenol plug at end. Hanger bracket provided. Price \$3.45

Dynamic Microphone

High Fi tape recorder microphone, moving coil, with a 4 wire, 5'-0" cord, for both high and low impedance, plastic housing, has a self-contained adjustable stand and bottom of housing is drilled and tapped for upright stand mounting. Price \$2.95

Weston DC Milliammeter, Model 801-S8

4 1/2" Rectangular
 Basic 0-5 Ma, OC
 Scale 0-1 in 50 divisions
 and 0-3 in 30 divisions
 Price \$4.95



Miniature "S" meter

Basic 0-200 microamperes, OC. Calibrated 0-5. Overall size 1" x 1" x 3/4" Price \$1.25 each

Terms of sale: Full payment or 20% with order. Minimum order \$2.

This is but a small fraction of the many thousands of electronic components contained in our latest 1965 catalog, free for your asking. Write to:

EDLIE ELECTRONICS, INC. Dept. RE-3
 (The Electronic Bargain House)
 154 Greenwich St., New York 6, N.Y.

Circle 127 on reader's service card

ADVERTISING INDEX

RADIO-ELECTRONICS does not assume responsibility for any errors which may appear in the index below.

MARKET CENTER

ELECTRONICS

FREE CATALOG of 200 special slide rules and calculating aids. DYNA-SLIDE, 600 South Michigan, Chicago, Illinois 60605

METERS-Surplus, new, used, panel and portable. Send for list. HANCHETT, Box 1898 Riverside, Calif.

TV CAMERAS, transmitters, converters, etc. Lowest factory prices. Catalog 10¢. VANGUARD, 190-48-99th Ave., Hollis, N.Y. 11423.

PROFESSIONAL ELECTRONICS PROJECTS — Organs, Timers, Computers, etc.—\$1 up. Catalog 25¢, refundable. PARKS, Box 25565, Seattle, Wash. 98125.

BEFORE You Buy Receiving Tubes, Transistors, Diodes, Electronic Components & Accessories... send for Giant Free Zalytron Current Catalog, featuring all STANDARD BRAND TUBES all Brand New Premium Individually Boxed, One Year Guarantee—all at BIGGEST DISCOUNTS in America! We serve professional servicemen, hobbyists, experimenters, engineers, technicians. WHY PAY MORE? ZALYTRON TUBE CORP., 469R Jericho Turnpike, Mineola, N.Y. 11502

SUB CARRIER DETECTOR



Add programs of commercial-free music thru your FM tuner. Detector, self-powered, plugs into multiplex output of tuner or easily wired into discriminator and permits reception of famous background music programs now transmitted as hidden programs on the FM broadcast band from coast to coast. Use with ANY FM tuner.

WIRED UNIT \$75.00
KIT, with pretuned coils, no alignment necessary \$49.50
crystal-controlled receivers available

MUSIC ASSOCIATED
65 Glenwood Road
Upper Montclair, New Jersey
phone 744-3387 area code 201

"TAB", SILICON 750MA* DIODES

Piv/Rms	Piv/Rms	Piv/Rms	Piv/Rms
650/35	100/70	200/140	300/210
.05	.09	.12	.14
400/280	500/350	600/420	700/490
.15	.19	.23	.27
800/560	900/630	1000/700	1100/770
.35	.45	.65	Query

ALL TESTS AC & DC & FWD & LOAD!

1700 Piv/1200Rms @ 750ma \$1.20 @ 10 for \$10 same 1100Piv/770Rms 75c @ 16 for \$11

D. C. Amps	50Piv 35Rms	100Piv 70Rms	200Piv 140Rms	300Piv 210Rms
3	.08	.12	.22	.27
12	.30	.50	.70	.85
35	.20	.30	.75	1.10
100	1.80	2.25	2.90	3.50
240	3.75	4.75	7.75	10.45

Sil. Pressfit 18A up to 100 Piv. AC-DC... 5 for \$1 Micro or Munch CSD 35 Amp/AC-DC... 4 for \$1

"TAB" * SCR'S * TRANSISTORS * DIODES!!!

Full Leads Factory Tested & Gtd! U.S.A. Mfg.
PNP HiPower/15Amp Round TO36 Pkg! 2N178 .443 174 up to 80V @ 2 for \$5
PNP Diamond/3A/2N155 .156 225 242 @ 3 for \$2
254 .255 257 301 351 c25 @ 4 for \$1
PNP Signal up to 350mw TO5 c25 @ 6 for \$1
PNP/Signal IF, RF, OSC. TO5 GVS c25 @ 6 for \$1
PNP 2N670 300mw c35 @ 4 for \$1
PNP 2N671 1 watt c50 @ 3 for \$1
Silicon PNP TO5 & TO18 Pkg c25 @ 5 for \$1
Power Heat Sink Finned 1005q \$1 @ 6 for \$5
STABISTOR Diodes Fwd Regulators 1 watt 5 for \$1
Zener Diodes up to One Watt 6to200V .70 @ 3 for \$2
TO36 or TO3 or TO10 Mica Mtg Kit c30 @ 4 for \$5
TO36/15 Amp Transistors Untested 4 \$1
TO3 3Amp Transistors Untested 10 \$1
12Amp Silicon Diodes Untested 50 \$1
Epoxy Diodes Silicon Untested 50 \$1
Fan Mblature & Motor 6 or 12V-C \$2 @ 6/\$9
Oil Condenser 10MFD @ 600WV \$1 @ 6/\$5
"SCR" Silicon Control (7A) Untested 5/\$1
"SCR" Silicon Control (25A) Untested 3/\$1

3000 Piv/2100Rms @ 200Ma \$1.80 @ 6 for \$10
6000 Piv/4200 Rms @ 200 Ma \$4 @ 4 for \$15
12000 Piv/8400 Rms @ 200Ma \$10 @ 3 for \$25
5U4 Silicon Tube Repl. \$7.90 @ 6 for \$11
Bulb Chgr 6 & 12v up to 5A \$8 @ 2 for \$15
ZENER AUTO IGNITION 50 to 60V/10 watt . \$1
2N538, 539, 540 3A/TO10 c60 @ 3 for \$4

Silicon Diodes 366 Amp Studs Untested 15 for \$1
Glass Diodes 1N34/48/60/64 Untested 20 for \$1

"TAB" TERMS: Money Back Guarantee. Our 20th year. \$2 Min. order F.O.B. N.Y.C. Add shpg charges 111-GO Liberty St., N. Y. 6, N. Y. SEND 25c Phone: KcTOR 2-6425 for CATALOG

Circle 128 on reader's service card

CLASSIFIED COMMERCIAL RATE (for firms or individuals offering commercial products or services): 60¢ per word . . . minimum 10 words.
NON-COMMERCIAL RATE (for individuals who want to buy or sell personal items): 30¢ per word . . . no minimum.
Payment must accompany all ads except those placed by accredited advertising agencies. 10% discount on 12 consecutive insertions, if paid in advance. Misleading or objectionable ads not accepted. Copy for December issue must reach us before October 10th.
WORD COUNT: Include name and address. Name of city (Des Moines) or of state (New York) counts as one word each. Zone or Zip Code numbers not counted. (We reserve the right to omit Zip Code if space does not permit.) Count each abbreviation, initial, single figure or group of figures or letters as a word. Symbols or groups such as 8x10, COD, AC, etc., count as one word. Hyphenated words count as two words. Minor over-wordage will be edited to match advance payment.

Allied Radio Corp.	108-111
B & K Manufacturing Co., (Div. of Dynascan Corp.)	23
Birnback Radio Co., Inc.	82
Blonder-Tongue	69
Brach Manufacturing Corp. (Div. of General Bronze Corp.)	72
Brooks Radio & TV Corp.	104-105, 106
Burstein-Applebee Co.	68
Capitol Radio Engineering Institute, The	28-31
Castle TV Tuner Service, Inc.	6
Centralab (Div. of Globe-Union Inc.)	2
CLASSIFIED	114-117
Cleveland Institute of Electronics	18-21, 24
Conar (Div. of National Radio Institute)	66
Cornell Electronics Co.	114
Dataq Corporation, The	92
DeVry Technical Institute	5
EICO Electronic Instrument Co., Inc.	32
Edlie Electronics, Inc.	115
Electro-Voice, Inc.	83
Electronic Measurement Corp. (EMC)	101
Fair Radio Sales	105
Finney Co.	71
Gensback Library, Inc.	93
Grantham School of Electronics	13
Heald's Engineering College	107
Heath Company	87-91
International Crystal Mfg. Co., Inc.	24, Third Cover

Jackson Electrical Instrument Company	16
Jerrold Electronics Corporation (Distributor Sales Division)	102
JFD Electronics Corp.	15
Lafayette Radio Electronics	95
Lectrotech Inc.	85
Mallory Distributor Products Company (Div. of P. R. Mallory & Co., Inc.)	17
Mercury Electronics Corporation	26
Multicore Sales Corp.	92
National Radio Institute	8-11
Olson Electronics, Inc.	72
Oxford Transducer Corporation	14
Poly Paks	117
Progressive "Edu-Kits" Inc.	103
RCA Electronic Components & Devices Test Equipment	25
Tubes	Fourth Cover
RCA Institutes, Inc.	62-65
Radar Devices Manufacturing Corp.	1
Radio Shack	118
Ray-Tel (Raytheon)	97
Record Club of America	7
R.F.S. Industries Inc.	70
Rye Sound Corporation	94
Sams & Co., Inc., Howard W.	27, 84
Sarkes Tarzian, Inc. (Tuner Service Div.)	22
Schober Organ Corp., The	12
Secore	96
Shure Brothers, Inc.	86
Sylvania (Subsidiary of General Telephone & Electronics)	73-80
Tarzian, Inc. Sarkes (Tuner Service Div.)	22
Texas Crystals (Div. of Whitehall Electronics Corp.)	107
Triplett Electrical Instrument Company, The	Second Cover
University Sound (Div. of LTV Ling Altec, Inc.)	70
Warren Electronic Components	106
Webster	101
Weiler Electric Co.	94
Wen Products, Inc.	67
Winegard Co.	61

MARKET CENTER 114-117
Edmund Scientific Corp.
Electronic Components Co.
Music Associated
TAB

SCHOOL DIRECTORY 113
American Institute of Engineering & Technology
Coyne Electronics Institute
Indiana Home Study Institute, The
Milwaukee School of Engineering
Northridge College of Science & Engineering
Northrop Institute of Technology
Tri-State College
Valparaiso Technical Institute

TRANSISTOR IGNITION! Coil, ballast 7.95 Free parts lists. TRANSFIRE Carlisle 20, Mass. 01741

ANY TV BONDED TUBE \$23.00. One year warr. (you keep the dud). Immediate delivery send check or money order. SAMSON KINESCOPIES INC., 250 N. Goodman St., Roch. N.Y. 14607

NEED RESISTORS? Factory fresh, NAME BRAND, 1/2 watt, 10% standard carbon resistors. Any regular value from 10 ohms to 2.2 megohms, \$.05 each! Postpaid. Any quantity assorted. Minimum order \$1.00. TEPCO, Box 508, Tullahoma, Tenn.

SCHEMATICS—\$1. Radio, Television. Prompt. BROWN's, 605 Naomi, Philadelphia, Penna. 19144.

TUBES. "Oldies", latest. Lists free. STEINMETZ, 7519 Maplewood, Hammond, Indiana, 46324.

RADIO & TV TUBES 33¢ each. One year guaranteed. Plus many unusual electronic bargains. Free catalog. CORNELL, 4217-E University, San Diego, California 92105

BUILD DIGITAL CIRCUITS that add, subtract, multiply, and divide using switches and diodes. Instructions. Any two functions \$1. FERWALT, Box 27, Lewiston, Idaho 83501.

FREE Catalog. Electronic parts, tubes. Wholesale. Thousands of items. Unbeatable prices. ARCTURUS ELECTRONICS RE, 502-22 St., Union City, N. J. 07087

DIAGRAMS, servicing information: Radio, \$1.00; Television, \$2.00. SUPREME, 1760 Balsam, Highland Park, Illinois 60035

WHOLESALE ELECTRONICS: Resistors 3¢, Speakers 49¢, Miniature Electrolytics 9¢. Hundreds of items. Buyers only. Catalog 25¢. Refundable. ROYAL, Box 2591, El Cajon, California.

PLANS ONE TUBE DX Shortwave kit (12,000 record) 24 pages—50¢. Experimenter's catalog 250 exclusive items—25¢, refundable. LABORATORIES, 993-B, Redwood City, California.

BUILD TV CAMERA cheaper than ever! Informative catalog 10¢. Box 396-R So. Sioux City, Nebr. 68776

McGEE RADIO COMPANY. Big 1966 catalog sent free. America's best values, Hi-Fi-amplifiers-speakers-electronic parts. Send name, address and zip code number to McGEE RADIO COMPANY, 1901 McGee Street, Dept. RE, Kansas City, Missouri 64108

TELEVISION CAMERAS transistorized also monitors. SPERA ELECTRONICS, 37-10 33 Street, Long Island City, N. Y.

JEEPS — WALKIE-TALKIES — Receivers — Oscilloscopes — Transmitters — Voltmeters. Uncle Sam's Bargain Prices. Write For Latest Exciting Details. ENTERPRISES, Box 402-F2, Jamaica, New York 11430.

WHOLESALE-APPLIANCE-lamps parts 25¢ brings catalogue. SECO, 112 South 20th Street, Birmingham, Alabama 35233.

EDUCATION/INSTRUCTION

LEARN ELECTRONIC ORGAN SERVICING. New home study course covering all makes electronic organ including transistors. Experimental kits—schematics—trouble-shooting. Accredited NHSCGI Approved. Write for free booklet. NILES BRYANT SCHOOL, 3631 Stockton Blvd., Dept. F, Sacramento 20, Calif.

HIGHLY—effective home study review for FCC commercial phone exams. Free literature! COOK'S SCHOOL OF ELECTRONICS, Craigmont, Idaho 83523.

FCC LICENSE in 6 weeks. First Class Radio Telephone. Results Guaranteed. ELKINS RADIO SCHOOL, 2603E Inwood, Dallas, Tex.

SLEEP LEARNING. Hypnotism! Tapes, records, books, equipment. Details, strange catalog FREE. RESEARCH ASSOCIATION, Box 24-RD, Olympia, Wash.

BROADCASTING—Communications Electronics taught quickly—resident classes; correspondence. Free details. Write: Dept. 4, GRANTHAM SCHOOLS, 1505 N. Western, Hollywood, Calif. 90027

FCC LICENSE training through tape recorded instruction. Bob Johnson AUDIO-VISUAL LICENSE PREPARATION, 221 S. Sepuveda, Manhattan Beach, Calif.

B.Sc. DEGREE (Engineering) or College Entrance by home study. Send \$1 for 1966 prospectus. CIST, Suite 651, 263 Adelaide Street W., Toronto, Canada.

CLASSIFIED ADVERTISING ORDER FORM

For complete data concerning classified advertising please refer to box elsewhere in Market Center section.

1	2	3	4	5
6	7	8	9	10
11	12	13	14	15
16	17	18	19	20
21	22	23	24	25
26	27	28	29	30
31	32	33	34	35

No. of Words { @ .30 Non-Commercial Rate } = \$ _____
 { @ .50 Commercial Rate }

Total Enclosed \$ _____ Payment must accompany order unless placed through accredited advertising agency 105

Insert _____ time(s) Starting with _____ issue

NAME _____

ADDRESS _____

CITY _____ STATE _____ ZIP _____

SIGNATURE _____

MAIL TO: RADIO-ELECTRONICS, CLASSIFIED AD DEPT., 154 WEST 14TH ST., NEW YORK, N.Y. 10011

1¢ SALE!

- DISC CONDENSERS . . . 30 for \$1 60 for 1.01
- PRECISION RESISTORS . . 30 for \$1 60 for 1.01
- PLANAR TRANSISTORS . . . 4 for \$1 8 for 1.01
- 25 AMP RECTIFIERS . . . 2 for \$1 4 for 1.01
- SWITCHING TRANS . . . 15 for \$1 30 for 1.01
- ZENER REFERENCES . . . 6 for \$1 12 for 1.01
- GERMANIUM DIODES . . . 25 for \$1 50 for 1.01
- TOP HAT RECTIFIERS . . . 25 for \$1 50 for 1.01
- TRANSISTORS . . . 30 for \$1 60 for 1.01
- 10-WATT ZENER 30V . . . 1 for \$1 2 for 1.01
- 2N1613 100MC TRANS . . . 1 for \$1 2 for 1.01
- 4W PLANARS 2N497-98 . . 2 for \$1 4 for 1.01
- 3N35 TETRODE TRANS . . . 1 for \$1 2 for 1.01
- 40-WATT TRANSISTORS . . 3 for \$1 6 for 1.01
- SOLAR "SUN" CELLS . . . 4 for \$1 8 for 1.01
- 200MC 2N705's . . . 2 for \$1 4 for 1.01
- MICRODIODES RECTFS . . 50 for \$1100 for 1.01
- EPOXY RECTIFIERS . . . 25 for \$1 50 for 1.01
- 10-WATT STUD ZENER . . . 1 for \$1 2 for 1.01
- 20W NPN SIL. 2N1647 . . 1 for \$1 2 for 1.01
- CLIP-IN DIODES . . . 15 for \$1 30 for 1.01
- STUD PWR TRANSISTORS . . 2 for \$1 4 for 1.01
- IGNITION SWGT TRANS . . 1 for \$1 2 for 1.01
- 115/60c TO 6.3A, 3A XFMR 1 for \$1 2 for 1.01

FREE WORTH OF Transistors, Diodes, Rectifiers, Knobs, Condensers, Coils, etc.

\$25

DOUBLE BONUS PLUS \$1 FREE POLY PAK OF YOUR CHOICE

Include 25¢ for handling

BOTH FREE WITH EVERY \$10 ORDER

- FACTORY TESTED **DOLLAR POLY PAKS**
- 3 TRANSISTOR AUDIO AMP, tiny, wired . . . \$1
 - MAGNETIC REED SWITCH, glass sealed . . . \$1
 - 40 WORLD'S SMALLEST COND., to .05mf . . . \$1
 - 4 TRANSISTOR TRANSFORMERS, asst. worth \$25 \$1
 - 1 FILAMENT TRANSFORMER, 117 to 6.3vct, 3A \$1
 - \$25 SURPRISE PAK, sealed, tiny types . . . \$1
 - 3 INFRA-RED DETECTORS, with leads . . . \$1
 - \$25 SURPRISE PAK: transistors, rect, diodes, etc. \$1
 - 30 CORNING "LOW NOISE" resistors, asst. . . \$1
 - 60 TUBULAR CONDENSERS, to .5mf, to 1Kv, asst \$1
 - 60 TUBE SOCKETS, receptacles, plugs, audio, etc. \$1
 - 30 POWER RESISTORS, 5 to 50W, to 24 Kohms. \$1
 - 50 MICA CONDENSERS, to .1mf, silvers too! . . \$1
 - 10 VOLUME CONTROLS, to 1 meg, switch too! . \$1
 - 10° ELECTROLYTICS, to 500mf, asst FF & tubulars \$1
 - 50 RADIO & TV KNOBS, asst. colors & styles . \$1
 - 10 TRANSISTOR ELECTROLYTICS; 10mf to 500mf \$1
 - 50 COILS & CHOKES, if, rf, ant, osc, & more . \$1
 - 35 TWO WATTERS, asst incl: A.B., 5% too! . . \$1
 - 75 HALF WATTERS, asst incl: A.B., 5% too! . . \$1
 - 60 HI-O RESISTORS, 1/2, 1, 2W, 1% & 5% values \$1
 - 10 PHONO PLUG & JACK SETS, tuners, amps . . \$1
 - 50 TERMINAL STRIPS, 1 to 8 solder lug types . \$1
 - 30 "YELLOW" MYLAR CONDENSERS, asst val \$1
 - 60 CERAMIC CONDENSERS, discs, nno's, to .05 \$1
 - 3 GEIGER COUNTER DETECTOR, tubes, assorted \$1
 - 3 TRANSISTOR TRANS'RS, 2N341, 42, 1W, npn \$1
 - 85 WATT 2N424 PLANAR, silicon, TO-53 npn. \$1
 - 85 WATT 2N1212 PLANAR, drift, 10mc, npn . \$1
 - 1 CONTROLLED SCR SWITCH, Transistor, TO18 . \$1

SILICON CONTROLLED RECTIFIERS

PRV	7 AMP	20 AMP
100	1.75	1.30
150	1.00	1.25
200	1.50	1.95
250	2.00	2.75
300	2.50	3.55
350	3.00	4.35
400	3.50	5.15
450	4.00	5.95
500	4.50	6.75
600	5.50	8.15

JUMBO PAKS

- 500 DISCS . . . 4.88
- 500 DISCS CERAMIC, PRECISIONS, TUB 4.88
- TRANSISTORS 100 for \$2.98

Power, Audio, RF, untested

- 10 1000 MC-1N251 GERMANIUM DIODES . . . \$1
- 2- CLAIREX PHOTO ELECTRIC CELL, CL607 . . \$1
- 2 500MC TRANS'RS, 2N964, mesas, npn, TO18 \$1
- 4 PIN HEAD 2N790 NPN SILICON transrs, TO18 \$1
- 4 2N43 OUTPUT TRANSISTORS, by GE, npn, TO5 \$1
- 4 2N333 NPN SILICON transistors, by GE, TO5 \$1
- 8, 2-6Amp RECT's, studs, silicon, 50 to 400V . \$1
- 4- 2N155 TRANSISTORS, or equals, TO3 cases \$1
- 2-800 MC, 2N709 NPN Silicon planar TO46 . . \$1
- 3 2N711 300MW, 300 MC, PNP MESA, TO18 . \$1
- 2N998 TYPE, 1000 GAIN, npn silicon, planar . \$1
- "MICRO-T" TRANSISTOR, like TMT-1613. . . \$1
- 4 2N35 TRANSISTORS, npn, by Sylvania, TO22 . \$1
- 4 "MICRO" TRANSISTORS, 2N131's, 1/16", rf \$1
- 4 CK721 TRANSISTORS, npn, aluminum case . \$1
- 5 2N107 TRANS'RS, by GE, npn, pop, audio pak \$1
- 10 PNP SWITCHING TRANSISTORS, 2N1305, TO6 \$1
- 15 PNP TRANSISTORS, CK722, 2N35, 107 . . . \$1
- 15 NPN TRANSISTORS, 2N35, 170, 440, . . . \$1

10¢ FOR OUR "XMAS" BARGAIN CATALOG ON: Semiconductors Poly Paks Parts

POLY PAKS TERMS: send check, money order, include postage—avg. wt. per pak 1" lb. RateH net 30 days. CODS 25%

P.O. BOX 942R SO. LYNNFIELD, MASS. "PAK-KING" of the World

RADIO SHACK IS NOW SELLING REALISTIC "Lifetime" TUBES TO DEALERS AND SERVICEMEN!



• The World's ONLY Lifetime-Guaranteed Tube: a FREE Replacement Whenever It Fails in the Set! • A Premium Tube at a Popular Price! • 24K Gold-Clad Contacts!

Hundreds of dealers and service men specify Realistic Lifetime Tubes because of the obvious PROFIT potential. If you're buying at 50% off list, check these prices—see how much more you'll save by switching to Lifetime Tubes!

Our stores don't compete with you because they sell at "each" prices, substantially more than your cost. Buy 100% GUARANTEED Lifetime Tubes at any Radio Shack, in person or by mail. Nobody but nobody has a deal like Lifetime!

NOW OVER 70 STORES COAST-TO-COAST

- ARIZONA**
PHOENIX — 3905 East Thomas Rd.
- CALIFORNIA**
BANKERSFIELD — 1308 19th St., 322-8448
LOS ANGELES
Ladera Shopping Center — 5305 Centinela Ave., Anaheim — 501 W. Katella Ave., 776-9540
Downey — Stonewood Shop, Ctr., 923-1709
La Habra — 1511 West Whittier Blvd.
Mission Hills — 10919 Sepulveda Blvd., 365-3118
Santa Ana — Bristol Plaza Shop, Ctr., 1212 South Bristol, 546-5700
Torrance — 22519 Hawthorne Blvd.
West Covina — 2516 East Workman Ave.
West L. A. — Pica Blvd. at Overland, 837-7141
SAN DIEGO (La Mesa) — Grossmont Shop, Ctr., 465-4062
LONG BEACH — 3976 Atlantic Ave., 426-7514
DANLAND (San Leandro) — Ray Fair Shop, Ctr., 278-5200
SACRAMENTO — 600 Fulton Ave., 483-2707
- COLORADO**
DENVER — 798 South Santa Fe Dr., 733-7833
- CONNECTICUT**
HAMDEN — Hamden Mart Shop, Ctr., 288-7811
MANCHESTER — Manchester Shopping Parkade, 649-5247
NEW HAVEN — 92 York St., 787-7121
NEW LONDON — New London Shop, Ctr., 442-0522
STAMFORD — 29 High Ridge Rd., 325-4371
WEST HARTFORD — 39 So. Main St., 238-5441
- ILLINOIS**
CHICAGO — Evergreen Plaza at 95th St., 636-9796
- MAINE**
PORTLAND — Pine Tree Shop, Ctr., 773-7071
- MASSACHUSETTS**
BOSTON
167 Washington St., 523-4719
154 Washington St., 426-3431
110 Federal St., 421-3997
BRANTREE — South Shore Plaza, 843-9200
BROCKTON — Westgate Mall, 508-3327
BROOKLINE — 730 Commonwealth Ave., 734-1000
CAMBRIDGE — Fresh Pond Shop, Ctr., 491-2925
FRAMINGHAM — Shoppers' World, 672-6569
LOWELL — Central Shop, Plaza, 465-5469
SAUGUS — N. E. Shop, Ctr., 233-5350
SPRINGFIELD — 1182 Main St., 734-2189
WEST SPRINGFIELD — Century Shop, Ctr., 732-4433
WORCESTER — Lincoln Plaza, 757-9030
- MINNESOTA**
ST. PAUL — 473 North Snelling, 222-4801
- MISSOURI**
ST. LOUIS — 1125 Pine St., 241-1125
- NEW HAMPSHIRE**
MANCHESTER — 1247 Elm St., 669-1303
- NEW MEXICO**
ALBUQUERQUE — 6315 Lomas, N.E., 268-5722
- NEW YORK**
BINGHAMTON (WestAl) — Vestal Shopping Plaza, 729-1525
BUFFALO (Glarencel) — Transilovna Shop, Ctr., 632-7111
NEW YORK — 1128 Ave. of the Americas, 687-4682
SCHENECTADY (Rotterdam) — Shoporama Shop, Ctr., 355-9740
SYRACUSE — 3057 Erie Blvd. East, 446-4990
- OHIO**
CINCINNATI — 852 Swifton Ctr., 631-4570
- OKLAHOMA**
OKLAHOMA CITY — Mayfair Shop, Ctr., 843-8491
TULSA — 2730 South Harvard, 742-2255
- OREGON**
PORTLAND — 1928 N.E. 42nd St., 281-4842
- PENNSYLVANIA**
PHILADELPHIA
23270 Cottman Ave., Roosevelt Mall, 338-4711
1128 Walnut St., 923-2198
- RHODE ISLAND**
CRANSTON — 1301 Reservoir Ave., 842-8600
EAST PROVIDENCE — Shoppers' Town, 434-3672
- TEXAS**
ABILENE — 2910 North First St., 673-8169
ARLINGTON — Collins at Park Row, 277-3151
BROWNSVILLE — 847 S.E. Elizabeth St., 546-6156
DALLAS
1601 Main St., 741-6279
Medallion Center, 363-8236
125 Wynwood Village, 948-3201
FORT WORTH
1515 So. University Dr., 335-4705
300 East Berry St., 927-7828
3524 East Denton Highway, 831-1957
HOUSTON
8458 Gulf Freeway, 642-4731
2315 Travis St., 523-0871
322 Northline Mall, 697-7914
Bellair — 4759 Bissonnet, 667-5190
SAN ANTONIO — 150 W. Wanda Shop, Ctr., 735-9169
SHERMAN — 1520 Highway 75 North, 892-8553
WACO — 1016 Austin Ave., 752-7739
- VIRGINIA**
ARLINGTON — Washington-Lee Shop, Ctr., 524-5422
- WASHINGTON**
SEATTLE
2028 Third Ave., 682-5280
837 N. E. 110th St., 364-8670

YOU BUY AT UP TO 70% + 10% OFF!

92 TYPES!

60 + 10% OFF
70% OFF
70 + 10% OFF

BUY BIG!

60 + 10% OFF
70% OFF
70 + 10% OFF

SAVE BIG!

60 + 10% OFF
70% OFF
70 + 10% OFF

Type	Sugg. List	3 of Type Or 10 Each	5 of Type Or 25 Each	10 of Type Or 50 Each	Type	Sugg. List	3 of Type Or 10 Each	5 of Type Or 25 Each	10 of Type Or 50 Each	Type	Sugg. List	3 of Type Or 10 Each	5 of Type Or 25 Each	10 of Type Or 50 Each
OZ4	2.55	.92	.77	.69	6BE6	2.20	.79	.66	.59	6W4GT	2.40	.86	.72	.65
1B3/1G3GT	2.90	1.04	.87	.79	6BG6GA	6.50	2.34	1.95	1.75	6W6GT	2.85	1.03	.86	.77
1K3	2.90	1.04	.87	.79	6BK7B	3.40	1.22	1.02	.92	6X4	1.65	.59	.50	.45
1R5	3.05	1.10	.92	.83	6BM8	3.05	1.10	.92	.83	6X8A	3.15	1.13	.95	.85
1U4	2.90	1.04	.87	.79	6BN6	3.20	1.15	.96	.86	12AD6/12GA6	2.40	.86	.72	.65
1U5	2.65	.95	.80	.72	6BQ5	2.40	.86	.72	.65	12AT6	1.85	.67	.56	.50
1X2B	3.05	1.10	.92	.83	6BQ6GTB	4.35	1.57	1.31	1.18	12AT7	3.05	1.10	.92	.83
2CY5	3.05	1.10	.92	.83	6BQ7A	3.95	1.42	1.19	1.07	12AU6	2.15	.77	.65	.58
3BZ6	2.30	.83	.69	.62	6BU8	3.35	1.21	1.01	.91	12AU7A	2.45	.88	.74	.67
3CB6	2.25	.81	.68	.61	6BZ6	2.25	.81	.68	.61	12AV6	1.65	.59	.50	.45
3V4	2.50	.90	.75	.68	6BZ7	4.00	1.44	1.20	1.08	12AX4GTB	2.70	.97	.81	.73
5AM8	3.95	1.42	1.19	1.07	6C4	1.85	.67	.56	.50	12AX7A	2.55	.92	.77	.69
5AQ5	2.35	.85	.71	.64	6CB6A	2.25	.81	.68	.61	12BA6	1.65	.59	.50	.45
5AR4	4.50	1.62	1.35	1.21	6CD6GA	5.80	2.09	1.74	1.57	12BE6	1.75	.63	.53	.48
5U4GB	2.10	.76	.63	.57	6CF6	2.55	.92	.77	.70	12BH7A	3.05	1.10	.92	.83
5U8	3.30	1.19	.99	.90	6CG7	2.45	.89	.74	.67	12BL6	2.65	.95	.80	.72
5Y3GT	1.75	.63	.53	.48	6CG8A	3.30	1.19	.99	.90	12BQ6GTB/12CU6	4.45	1.60	1.34	1.21
6AG5	2.75	1.00	.83	.75	6CM7	2.90	1.04	.87	.78	12BY7A	3.20	1.15	.96	.86
6AL5	1.85	.67	.56	.50	6CX8	4.20	1.51	1.26	1.14	12DQ6B	4.20	1.51	1.26	1.14
6AM8A	3.45	1.25	1.04	.94	6DQ6B	4.15	1.49	1.25	1.13	12SQ7GT	3.75	1.35	1.13	1.02
6AN8A	4.00	1.44	1.20	1.08	6EA8	3.20	1.15	.96	.86	17DQ6B	4.20	1.51	1.26	1.14
6AQ5	2.15	.77	.65	.58	6E88	4.20	1.51	1.26	1.14	25L6GT	2.65	.95	.80	.72
6AS5	2.90	1.04	.87	.79	6GH8	3.15	1.13	.95	.85	35C5	2.15	.77	.65	.58
6AU4GTA	3.60	1.30	1.08	.97	6J6A	2.85	1.03	.86	.77	35W4	1.10	.40	.33	.30
6AU6A	2.10	.76	.63	.57	6K6GT	2.65	.95	.80	.72	35Z5GT	1.85	.67	.56	.50
6AU8A	4.20	1.51	1.26	1.13	6L6GC	4.35	1.57	1.31	1.18	50C5	2.15	.77	.65	.58
6AV6	1.65	.60	.50	.45	6S4A	2.50	.90	.75	.67	50EH5	2.30	.83	.69	.62
6AW8	3.70	1.33	1.11	1.00	6SN7GTB	2.60	.94	.78	.69	50L6GT	2.55	.92	.77	.69
6AX4GTB	2.65	.95	.80	.72	6T8A	3.40	1.22	1.02	.92	7199	4.70	1.69	1.41	1.27
6BA6	2.00	.72	.60	.54	6U8A	3.30	1.19	.99	.89	7591	3.00	1.08	.90	.81
6BC5/6CE5	2.35	.85	.71	.64	6V6GT	2.20	.79	.66	.59					

MAIL TODAY OR BUY AT ANY RADIO SHACK STORE

Please send me the following Lifetime tubes:

ADD 50¢ PER ORDER FOR PACKING AND SHIPPING — ANYWHERE IN THE U.S.A.

RE-1065

Amount Enclosed \$

Quan.	Tube Type	Quan.	Tube Type	Quan.	Tube Type

Please send FREE 1966 Radio Shack Catalog!

NAME (please print) _____

COMPANY _____

STREET _____

CITY _____

STATE _____

ZIP _____

Circle 130 on reader's service card

NEW

FROM INTERNATIONAL

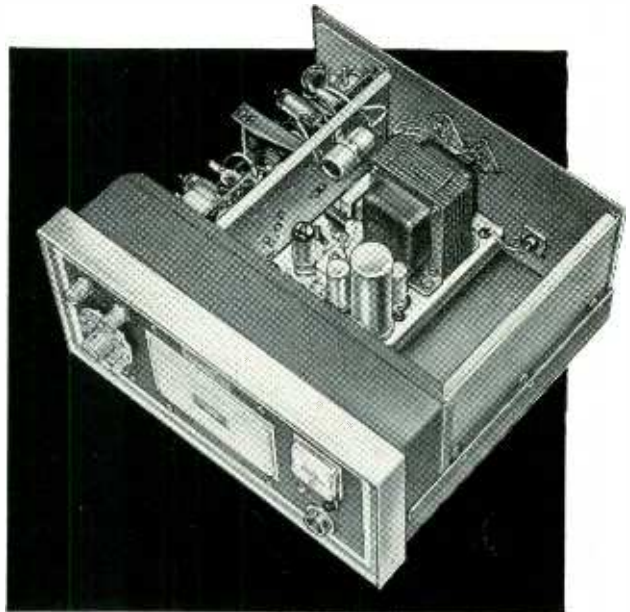

MODEL 660 CITIZENS RADIO TRANSCEIVER

The International Model 660 . . . new in styling . . . new in advanced technical features, combines space-age colors and decor with greater operating convenience.

Designed for base and mobile installations, the Model 660 provides instant push-to-talk operation on all 23 channels. Silicon transistors and tubes are combined in a new hybrid circuit for the highest degree of reliability.

A transistor power supply operates from 6/12 or 115 vac power sources.

See the International Model 660 at your dealer today. It comes complete with crystals, dynamic microphone with coil cord.

- Distinctive New Panel Design
- New Hybrid Circuits
- New Zener Speech Limiter
- Frequency Synthesized Crystal Controlled 23 Channel Operation
- Dual Conversion Receiver
- Illuminated Channel Selector Dial
- Ten Tubes
- Five Silicon Transistors
- Two Power Transistors
- Eleven Silicon Diodes

Write Today For The Name Of Your Nearest International Dealer.

FCC Citizens Radio license required. All use must conform with Part 95, FCC Rules and Regulations.



RCA all-new, rare-earth Hi-Lite Color Picture Tubes are being stocked by smart dealers who are ready for the replacement color picture tube business.

why?

Hi-Lite's rare-earth phosphors provide picture brightness unsurpassed in the color TV industry. Natural color reproduction. Great black-and-white pictures, too! **RCA's Hi-Lite Color Picture Tube Line is here. Now! Available in 19-inch and 25-inch rectangulars and 21-inch round tube types.**

What about you? Are you ready for color?

RCA ELECTRONIC COMPONENTS AND DEVICES, HARRISON, N.J.



The Most Trusted Name in Electronics

